

**Advanced Quantum Field Theory**  
**Lent Term 2013**  
**Hugh Osborn**

Latex Lecture notes, originally typeset by  
Steffen Gielen in 2007  
revised by  
Carl Turner in 2013

latest update: June 30, 2013



## Books

There are many books on quantum field theory, most are rather long. All those listed are worth looking at.

**M.E. Peskin and D.V. Schroeder**, *An Introduction to Quantum Field Theory*

842p., Addison-Wesley Publishing Co. (1996).

A good introduction with an extensive discussion of gauge theories including QCD and various applications.

**M. Srednicki**, *Quantum Field Theory*

641p., Cambridge University Press (2007).

A comprehensive modern book organised by considering spin-0, spin- $\frac{1}{2}$  and spin-1 fields in turn.

**S. Weinberg**, *The Quantum Theory of Fields*

vol. I *Foundations*, 609p., vol. II *Modern Applications*, 489p., Cambridge University Press (1995,1996).

Written by a Nobel Laureate, contains lots of details which are not covered elsewhere, perhaps a little idiosyncratic and less introductory than the above. There is a third volume on supersymmetry.

**J. Zinn-Justin**, *Quantum Field Theory and Critical Phenomena*, **4th ed.**

1054p., Oxford University Press (2002).

Devotes a large proportion to applications to critical phenomena in statistical physics but covers gauge theories at some length as well; not really an introductory book.

**C. Itzykson and J-B. Zuber**, *Quantum Field Theory*

705p., McGraw-Hill International Book Co. (1980).

At one time the standard book, contains lots of detailed calculations but the treatment of non abelian gauge theories is a bit cursory and somewhat dated.

**T. Banks**, *Modern Quantum Field Theory, A Concise Introduction*

271p., Cambridge University Press (2008).

As it says quite concise, contains an interesting selection of subjects and useful for supplementary reading.

**L. Alvarez-Gaume and M.A. Vazquez-Mozo**, *An Invitation to Quantum Field Theory*

294p., Springer (2012).

Rather introductory.

**M. Shifman**, *Advanced Topics in Quantum Field Theory*

622p., Cambridge University Press (2012).

As the title indicates not an introduction but contains material on non perturbative approaches.

There are also many much more mathematical approaches to quantum field theory, many very sophisticated.

**J. Dimock**, *Quantum Mechanics and Quantum Field Theory: A Mathematical Primer*

283 p., Cambridge University Press (2011).

Some more mathematical stuff than usual.

**P. Deligne et al.**, *Quantum Fields and Strings: A Course for Mathematicians*, **vol. I,II**

1499p., ed. P. Deligne, P. Etingof, D.S. Freed, L.C. Jeffrey, D. Kazhdan, J.W. Morgan, D.R. Morrison, E. Witten, American Mathematical Society (1999).

Contains various articles by world renowned physicists and mathematicians, at a level from the almost trivial to the sublime to the incomprehensible. A very alternative view.

**K. Fredenhagen and K. Rejzner**, *Perturbative algebraic quantum field theory*

arXiv:1208.1428

A review of the mathematical approach to QFT.

## Online material

**W Siegel**, *Fields*

885p., hep-th/9912205 or <http://de.arxiv.org/pdf/hep-th/9912205>.

Contains additional material on GR, Strings, Supersymmetry, Supergravity, an unusual point of view.

**S. Coleman**, *Notes from Sidney Coleman's Physics 253a*

337p., arXiv:1110.5013.

Notes from Sidney Coleman's lectures at Harvard in 1986. He was renowned for his lecturing, the notes are very introductory.

**L. Alvarez-Gaume and M.A. Vazquez-Mozo**, *Introductory Lectures on Quantum Field Theory*

hep-th/0510040.

Rather elementary.

For more specialised material see

**M. Polyak**, *Feynman Diagrams for Pedestrians and Mathematicians*

arXiv:math/0406251.

I found the first part instructive.

**M. Flory, R.C. Helling and C. Sluka**, *How I Learned to Stop Worrying and Love QFT*

23p., arXiv:1201.2714.

Some nice remarks on QFT but there are quite a few typos.

**D. Harlow**, *A Simple Bound on the Error of Perturbation Theory in Quantum Mechanics*

arXiv:0905.2466.

Has a simple discussion of convergence of perturbation theory.

**E. Witten**, *Notes On Supermanifolds and Integration*

arXiv:1209.2199.

A fairly accessible discussion of integrals over Grassman variables.

## Specialist topics

**J.C. Collins**, *Renormalization*

380p., Cambridge University Press (1984).

The introductory chapters and discussion of dimensional regularization are good, later chapters are rather technical and perhaps better covered elsewhere.

**H. Kleinert**, *Path Integrals in Quantum Mechanics, Statistics, Polymer Physics, and Financial Markets*, **3rd ed.**

1468p., World Scientific (2003).

Not a field theory book but the bible on path integrals.

For an historical perspective it is instructive to read

**S.S. Schweber**, *QED and the Men Who Made It: Dyson, Feynman, Schwinger and Tomonaga*

732p., Princeton University Press (1994).

This is a history of how Feynman, Schwinger and Tomonaga learned how to calculate in quantum field theory, and Dyson showed how Feynman rules could be derived.

**L. O'Raiheartaigh**, *The Dawning of Gauge Theory*

249p., Princeton University Press (1997).

Describes the rather tortuous route to understanding gauge invariance.

**D.J. Gross**, *Oscar Klein and Gauge Theory*  
hep-th/9411233.

**S. Weinberg**, *What is Quantum Field Theory, and What Did We Think It Is?*  
hep-th/9702027.

# Contents

<b>1</b>	<b>Path Integrals</b>	<b>1</b>
1.1	Standard Approach to Quantum Mechanics . . . . .	1
1.2	Path Integral in One-Particle Quantum Mechanics . . . . .	2
1.2.1	Example: The Harmonic Oscillator . . . . .	5
1.2.2	A Few Comments . . . . .	8
1.3	GAUSSIAN Integrals and Extensions Over Multi-Dimensional Coordinates . . . . .	10
1.4	Non-GAUSSIAN Integrals and Perturbation Expansions . . . . .	14
<b>2</b>	<b>Functional Methods in Quantum Field Theory</b>	<b>18</b>
2.1	Free Scalar Field Theory . . . . .	18
2.2	Interacting Scalar Field Theory . . . . .	21
2.2.1	Feynman Rules for Interacting Scalar Field Theory . . . . .	22
2.2.2	Connected and Disconnected Graphs . . . . .	25
2.2.3	One Particle Irreducible Graphs . . . . .	28
2.2.4	Tree Approximation . . . . .	31
2.3	FERMIONIC Fields . . . . .	31
2.3.1	GAUSSIAN Integrals for GRASSMANN Variables . . . . .	33
2.3.2	The FERMIONIC Oscillator . . . . .	34
2.3.3	Path Integral Formalism for FERMIONIC Fields . . . . .	35
2.3.4	Canonical Treatment . . . . .	37
2.3.5	Propagators . . . . .	37
<b>3</b>	<b>Operator Aspects of Quantum Field Theory</b>	<b>39</b>
3.1	Symmetries and NOETHER's theorem . . . . .	39
3.2	WARD Identities . . . . .	39
3.3	Energy Momentum Tensor . . . . .	40
3.4	Relation of $n$ -Point Functions and Scattering Amplitudes . . . . .	42
<b>4</b>	<b>Calculation of FEYNMAN Amplitudes and Divergences</b>	<b>46</b>
4.1	Two Key Ideas . . . . .	46
4.1.1	WICK Rotation . . . . .	46
4.1.2	Appearance of Divergences in FEYNMAN Integrals . . . . .	47
4.2	Regularisation . . . . .	50
4.2.1	Dimensional Regularisation for One-Loop Graphs . . . . .	51
4.2.2	Dimensional Regularisation for Two-Loop Graphs . . . . .	57
4.3	Renormalisation and the Renormalisation Group . . . . .	61
4.3.1	Bare LAGRANGians . . . . .	62
4.3.2	The CALLAN-SYMANZIK Equation . . . . .	63
4.3.3	Evolution of Coupling Constants . . . . .	66
4.4	Effective Potentials . . . . .	69
<b>5</b>	<b>Gauge Theories</b>	<b>72</b>
5.1	Brief Summary of LIE Algebras and Gauge Fields . . . . .	72

5.2	Gauge Fields in Quantum Field Theory . . . . .	74
5.3	Example: Ordinary Finite Integral . . . . .	76
5.4	Introduction of Ghost Fields . . . . .	78
5.5	FEYNMAN Rules for Gauge Theories . . . . .	79
5.6	Canonical Approach . . . . .	82
5.7	BRS Symmetry . . . . .	83
5.8	Renormalisation of Gauge Theories . . . . .	87
5.8.1	Calculation of $\beta(g)$ at One Loop . . . . .	91
<b>6</b>	<b>Fermion Currents and Anomalies</b>	<b>98</b>
6.1	Example: Symmetries of the DIRAC LAGRANGian . . . . .	98
6.2	Triangle Graphs . . . . .	99

# Introduction

The course “Advanced Quantum Field Theory” will build on the course “Quantum Field Theory” taught in Michaelmas Term. It will extend the material covered in this course to interacting theories (including loops) and more realistic theories, which can at least potentially predict experimental results. It will also introduce how to deal with gauge theories.

The basic message that this course tries to convey is:

*Quantum field theory is the basic language of particle physics, and also large parts of statistical physics.*

Quantum field theory is a subject with many technical complications; we will try to deal with these ‘step by step’. It is, however, not a branch of mathematics yet. The lectures will not be rigorous from a pure mathematical point of view.

In quantum field theory, the number of particles involved is potentially infinite, whereas ordinary quantum mechanics deals with states describing one particle or a fixed number of particles. Quantum field theory is quantum mechanics with an infinite number of degrees of freedom. We are dealing with fields  $\phi(\vec{x}, t)$  defined on space-time. Quantisation of free fields defines a space of states, or FOCK<sup>1</sup> space:

- a vacuum state  $|0\rangle$ , which has zero energy,
- single-particle states  $|\vec{p}\rangle$ , which have energy  $E(\vec{p}) = \sqrt{\vec{p}^2 + m^2}$ ,
- multi-particle states  $|\vec{p}_1, \vec{p}_2, \dots, \vec{p}_n\rangle$ , which have energy  $E(\vec{p}_1) + \dots + E(\vec{p}_n)$ .

(Note that we use units in which  $c = \hbar = 1$ .)

We introduce creation and annihilation operators  $a^\dagger(\vec{p}), a(\vec{p})$ , such that  $|\vec{p}\rangle = a^\dagger(\vec{p})|0\rangle$  etc. Fields after quantisation change the number of particles. Whereas the number of particles is conserved in the free theory, interactions can change the number of particles.

Quantisation takes you from *fields* to *particles*. (For example, quantising the electromagnetic field leads to photons with energy  $E = |\vec{p}|$ .)

## 1 Path Integrals

In this first chapter, a different approach to quantum mechanics will be presented, the *path integral approach*. We start with ordinary quantum mechanics, and the formalism will generalise to quantum field theory.

### 1.1 Standard Approach to Quantum Mechanics

We start from a classical LAGRANGIAN<sup>2</sup> describing a system with  $n$  degrees of freedom  $q^i$ ,  $i = 1, \dots, n$

$$L(q^i, \dot{q}^i). \quad (1.1)$$

In the HAMILTONIAN<sup>3</sup> formalism, we replace  $\dot{q}^i$  by the conjugate momenta  $p_i$

$$p_i = \frac{\partial L}{\partial \dot{q}^i}, \quad H(q^i, p_i) = \dot{q}^i p_i - L(q^i, \dot{q}^i). \quad (1.2)$$

On quantisation, the coordinate and momenta become operators  $\hat{q}^i, \hat{p}_i$  satisfying the (*equal time*) *commutation relations*

$$[\hat{q}^i(t), \hat{p}_j(t)] = i\hbar \delta^i_j \hat{1}. \quad (1.3)$$

<sup>1</sup>Fock, Vladimir Aleksandrovich (1898-1974)

<sup>2</sup>Lagrange, Joseph Louis (1736-1813)

<sup>3</sup>Hamilton, Sir William Rowan (1805-1865)



The generalisation of this in field theory for scalar fields is

$$[\hat{\phi}(\vec{x}, t), \dot{\hat{\phi}}(\vec{y}, t)] = i\hbar \delta^{(3)}(\vec{x} - \vec{y}) \hat{\mathbf{1}}. \quad (1.4)$$

(From now on  $\hbar = 1$ ).

The canonical approach is non-covariant and relativistic invariance is lost because of requiring equal times (and thus picking a preferred frame in which time is measured). LORENTZ<sup>4</sup> invariance is not manifest in a conspicuous way. That makes it hard to derive perturbation expansions in terms of FEYNMAN<sup>5</sup> rules.

FEYNMAN invented the *path integral approach*, which avoids a non-covariant approach, and is equivalent to the standard operator approach. It is better equipped for dealing with gauge theories, for example.

## 1.2 Path Integral in One-Particle Quantum Mechanics

In this section the path integral for a single particle will be derived, given operators  $\hat{\mathbf{p}}, \hat{\mathbf{q}}$  and a classical HAMILTONIAN

$$H(q, p) = \frac{p^2}{2m} + V(q), \quad (1.5)$$

which corresponds to a quantum mechanical operator

$$\hat{\mathbf{H}} = H(\hat{\mathbf{q}}, \hat{\mathbf{p}}), \quad (1.6)$$

where  $\hat{\mathbf{q}}, \hat{\mathbf{p}}$  satisfy  $[\hat{\mathbf{q}}, \hat{\mathbf{p}}] = i\hat{\mathbf{1}}$ . The SCHRÖDINGER<sup>6</sup> equation

$$i \frac{\partial}{\partial t} |\psi\rangle = \hat{\mathbf{H}} |\psi\rangle \quad (1.7)$$

determines the time evolution of states. The (formal) solution to the SCHRÖDINGER equation is

$$|\psi(t)\rangle = \exp(-i\hat{\mathbf{H}}t) |\psi(0)\rangle, \quad (1.8)$$

since  $\hat{\mathbf{H}}$  is independent of time.

We can also consider position states, satisfying

$$\hat{\mathbf{q}}(t) |q, t\rangle = q |q, t\rangle, \quad (1.9)$$

where  $q$  is any real number. We use the convenient normalisation

$$\langle q', t | q, t \rangle = \delta(q' - q). \quad (1.10)$$

Here consider the SCHRÖDINGER picture, where states  $|\psi(t)\rangle$  depend on time, and operators  $\hat{\mathbf{q}}, \hat{\mathbf{p}}$  are fixed. Therefore, the states  $\{|q\rangle\}$  are time-independent, and form a basis for any state. We can define a *wave function*

$$\psi(q, t) = \langle q | \psi(t) \rangle, \quad (1.11)$$

and acting on wave functions

$$\hat{\mathbf{H}} \rightarrow -\frac{1}{2m} \frac{d^2}{dq^2} + V(q). \quad (1.12)$$

The path integral approach expresses time evolution of states in terms of possible trajectories of particles. First write the wave function as

$$\psi(q, t) = \langle q | \exp(-i\hat{\mathbf{H}}t) | \psi(0) \rangle \quad (1.13)$$

and introduce a complete set of states  $|q_0\rangle$ , such that

$$\hat{\mathbf{1}} = \int dq_0 |q_0\rangle \langle q_0|, \quad (1.14)$$

<sup>4</sup>Lorentz, Hendrik Antoon (1853-1928), Nobel Prize 1902

<sup>5</sup>Feynman, Richard Phillips (1918-1988), Nobel Prize 1965

<sup>6</sup>Schrödinger, Erwin Rudolf Josef Alexander (1887-1961), Nobel Prize 1933

to rewrite this result as

$$\psi(q, t) = \int dq_0 \langle q | \exp(-i\hat{\mathbf{H}}t) | q_0 \rangle \langle q_0 | \psi(0) \rangle = \int dq_0 K(q, q_0; t) \psi(q_0, 0). \quad (1.15)$$

The SCHRÖDINGER equation has been converted into an integral expression, where

$$K(q, q_0; t) := \langle q | \exp(-i\hat{\mathbf{H}}t) | q_0 \rangle. \quad (1.16)$$

Consider the evolution of the wave function over a time interval  $0 \leq t \leq T$  and divide this interval up into smaller intervals  $0 = t_0 < t_1 < t_2 < \dots < t_{n+1} = T$ . (These intervals are not necessarily of equal length, though it may often be convenient to choose them to be so.) Then rewrite

$$\exp(-i\hat{\mathbf{H}}T) = \exp(-i\hat{\mathbf{H}}(t_{n+1} - t_n)) \exp(-i\hat{\mathbf{H}}(t_n - t_{n-1})) \dots \exp(-i\hat{\mathbf{H}}t_1). \quad (1.17)$$

At each  $t_r$ , where  $r = 1, \dots, n$ , now introduce complete sets of states:

$$K(q, q_0; T) = \int \prod_{r=1}^n (dq_r \langle q_{r+1} | \exp(-i\hat{\mathbf{H}}(t_{r+1} - t_r)) | q_r \rangle) \cdot \langle q_1 | \exp(-i\hat{\mathbf{H}}t_1) | q_0 \rangle, \quad (1.18)$$

where we set  $q_{n+1} = q$ . That means that the integration goes over all possible values of  $q$  at  $t_1, t_2, \dots, t_n$ , as the value of  $q$  evolves from  $q_0$  at  $t = 0$  to  $q$  at  $t = T$ :

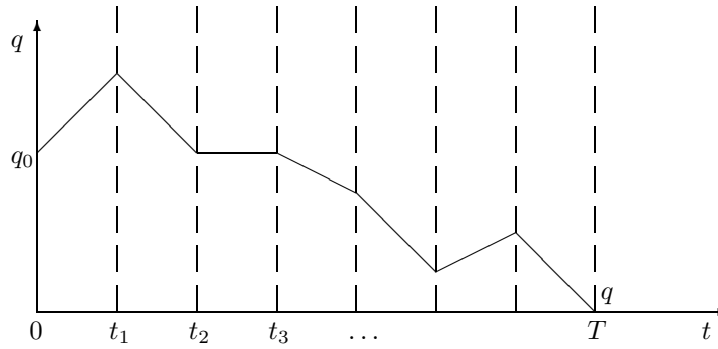

Up to now, the calculation has only been complicated, and there is no straightforward way for an explicit solution of the problem for an arbitrary potential  $V(q)$ .

We will approximate the factors

$$\langle q_{r+1} | \exp(-i\hat{\mathbf{H}}\delta t) | q_r \rangle \quad (1.19)$$

arising in (1.18) for small  $\delta t = t_{r+1} - t_r$ . But first consider a case where these expressions can be evaluated explicitly, that is free theory, with  $V = 0$ . In fact, the result

$$K_0(q, q'; t) := \langle q | \exp(-i\frac{\hat{\mathbf{p}}^2}{2m}t) | q' \rangle \quad (1.20)$$

is valid for any value of  $t$ . To show this we use a complete set of momentum states  $\{|p\rangle\}$  (i.e. states which satisfy  $\hat{\mathbf{p}}|p\rangle = p|p\rangle$ ) such that

$$\hat{\mathbf{1}} = \int \frac{dp}{2\pi} |p\rangle \langle p|. \quad (1.21)$$

A basic result from quantum mechanics is that

$$\langle q | p \rangle = e^{ip \cdot q}, \quad (1.22)$$

which can be easily obtained by noting that when acting on wave functions,  $\hat{\mathbf{p}} \rightarrow -i\frac{d}{dq}$ . Furthermore,

$$\langle p | q' \rangle = e^{-ip \cdot q'}. \quad (1.23)$$

This means that

$$K_0(q, q'; t) = \int \frac{dp}{2\pi} \langle q | \exp(-i\frac{\hat{p}^2}{2m}t) | p \rangle \langle p | q' \rangle = \int \frac{dp}{2\pi} e^{-i\frac{p^2}{2m}t} e^{ip(q-q')} . \quad (1.24)$$

Upon the substitution  $p' = p - \frac{m(q-q')}{t}$  this becomes

$$K_0(q, q'; t) = e^{im\frac{(q-q')^2}{2t}} \int \frac{dp'}{2\pi} e^{-i\frac{p'^2}{2m}t} = e^{im\frac{(q-q')^2}{2t}} \sqrt{\frac{m}{2\pi it}} , \quad (1.25)$$

where in the last step the integrand was rotated by  $p' = e^{-i\frac{\pi}{4}} r$ , so that

$$\int \frac{dp'}{2\pi} e^{-i\frac{1}{2}p'^2} = e^{-i\frac{\pi}{4}} \int \frac{dr}{2\pi} e^{-\frac{1}{2}r^2} = \frac{1}{2\pi} e^{-i\frac{\pi}{4}} \sqrt{\frac{2\pi}{\lambda}} . \quad (1.26)$$

Note that in the limiting case  $t \rightarrow 0$ , we have  $K_0(q, q'; t) \rightarrow \delta(q - q')$ , as necessary.

Let us return to (1.18), our integral expression for  $K(q, q_0; T)$ :

$$K(q, q_0; T) = \int \prod_{r=1}^n \left( dq_r \langle q_{r+1} | \exp(-i\hat{H}(t_{r+1} - t_r)) | q_r \rangle \right) \cdot \langle q_1 | \exp(-i\hat{H}t_1) | q_0 \rangle .$$

We will in due course take the limit  $n \rightarrow \infty$  and  $t_{r+1} - t_r \rightarrow 0$  for each  $r$ . We are concerned with finding an approximation for  $\exp(-i\hat{H}\delta t)$  for small  $\delta t$ . One thing to note is that if  $\hat{A}$  and  $\hat{B}$  are operators, then in general

$$\exp(\hat{A} + \hat{B}) \neq \exp(\hat{A}) \exp(\hat{B}) . \quad (1.27)$$

In fact, one can obtain an expression

$$\exp(\hat{A}) \exp(\hat{B}) = \exp \left( \hat{A} + \hat{B} + \frac{1}{2} [\hat{A}, \hat{B}] + \dots \right) . \quad (1.28)$$

However, we can say that for small  $\epsilon$

$$\exp(\epsilon(\hat{A} + \hat{B})) = \exp(\epsilon\hat{A}) \exp(\epsilon\hat{B}) (1 + O(\epsilon^2)) , \quad (1.29)$$

since all following terms in the summation include commutators of  $\hat{A}$  and  $\hat{B}$ . This implies

$$\exp(\hat{A} + \hat{B}) = \lim_{n \rightarrow \infty} \left( \exp(\hat{A}/n) \exp(\hat{B}/n) \right)^n . \quad (1.30)$$

Hence, if  $\delta t$  is small, we can write

$$\exp(-i\hat{H}\delta t) = \exp \left( -i\frac{\hat{p}^2}{2m}\delta t \right) \exp \left( -iV(\hat{q})\delta t \right) (1 + O(\delta t^2)) , \quad (1.31)$$

and so to leading order as  $\delta t \rightarrow 0$ ,

$$\langle q_{r+1} | \exp(-i\hat{H}\delta t) | q_r \rangle = \langle q_{r+1} | \exp \left( -i\frac{\hat{p}^2}{2m}\delta t \right) \exp(-iV(\hat{q})\delta t) | q_r \rangle . \quad (1.32)$$

Because the states  $|q_r\rangle$  are eigenstates of the operator  $\hat{q}$ , the second exponential can actually be factored out:

$$\begin{aligned} \langle q_{r+1} | \exp(-i\hat{H}\delta t) | q_r \rangle &= e^{-iV(q_r)\delta t} \langle q_{r+1} | \exp \left( -i\frac{\hat{p}^2}{2m}\delta t \right) | q_r \rangle \\ &= \sqrt{\frac{m}{2\pi i\delta t}} e^{i\frac{1}{2}m\left(\frac{q_{r+1}-q_r}{\delta t}\right)^2\delta t - iV(q_r)\delta t} , \end{aligned} \quad (1.33)$$

using the result (1.25) derived before for the free theory.

We return to the task of calculating  $K(q, q_0; T)$  in (1.18), conveniently writing  $t_{r+1} - t_r = \delta t$ , so that the time interval is divided into equal increments:

$$K(q, q_0; T) = \left( \frac{m}{2\pi i\delta t} \right)^{\frac{1}{2}(n+1)} \int \prod_{r=1}^n dq_r e^{i\sum_{r=0}^n \left( \frac{1}{2}m\left(\frac{q_{r+1}-q_r}{\delta t}\right)^2 - V(q_r) \right) \delta t} , \quad q_{n+1} = q . \quad (1.34)$$

The path integral is obtained by considering the limit as  $n \rightarrow \infty$  and  $\delta t \rightarrow 0$ . Firstly in the exponent

$$\sum_{r=0}^n \left( \frac{m}{2} \left( \frac{q_{r+1} - q_r}{\delta t} \right)^2 - V(q_r) \right) \delta t \longrightarrow S[q], \quad (1.35)$$

where

$$S[q] = \int_0^T dt \left( \frac{1}{2} m \dot{q}^2 - V(q) \right) = \int_0^T dt L(q, \dot{q}). \quad (1.36)$$

Here  $L(q, \dot{q}) = \frac{1}{2} m \dot{q}^2 - V(q)$  is the classical LAGRANGIAN and the notation  $S[q]$  denotes a dependence on a function  $q(t)$  defined on the given interval. While a function assigns a number to a number,  $S$  is a functional which assigns a number to a given function, the *action*. Note that the functions  $q(t)$  have the following property

$$q(0) = q_0, \quad q(T) = q. \quad (1.37)$$

As a formal definition, we also let

$$\sqrt{\frac{m}{2\pi i \delta t}} \cdot \prod_{r=1}^n \left( \sqrt{\frac{m}{2\pi i \delta t}} dq_r \right) \rightarrow d[q]. \quad (1.38)$$

The expression  $d[q]$  can be given a more precise mathematical meaning in certain situations, but we take the limit as a physicist, not worrying about any mathematical idiosyncrasies which can be very non trivial. If necessary it should be defined by the limit of the discrete product given on the left of (1.38) as  $n \rightarrow \infty$  and  $\delta t = \frac{T}{n} \rightarrow 0$ . What then needs to be done is to show that limit exists for any  $V(q)$ . However ultimately, we can write for the limit

$$\boxed{K(q, q_0; T) = \langle q | \exp(-i\hat{H}T) | q_0 \rangle = \int d[q] e^{iS[q]},} \quad (1.39)$$

and usually the precise details of the limiting process may be ignored.

The path integral is a sum over all paths between  $q$  and  $q_0$  weighted by  $e^{iS}$ . It represents the fact that the classical concept of a trajectory has no validity in quantum mechanics; in the double-slit experiment, it is impossible to tell which path a particle has taken that is registered on the screen. Unlike in classical physics, where there usually is a unique path, or at least a finite number of paths, and certainly not a continuous range, we have to take all possible trajectories into account when dealing with quantum mechanics.

This *path integral* (or *functional integral*) formalism is an alternative approach to quantum mechanics which in many ways is quite intuitive. To illustrate it in more detail, let us consider an example where the path integral can be carried out explicitly.

### 1.2.1 Example: The Harmonic Oscillator

Consider the potential

$$V(q) = \frac{1}{2} m \omega^2 q^2. \quad (1.40)$$

This is the harmonic oscillator, of course. It is one of basically two solvable problems in quantum mechanics, the second one being the hydrogen atom.<sup>7</sup> All paths  $q(t)$  have the property that

$$q(0) = q_i, \quad q(T) = q_f. \quad (1.41)$$

In this case, the classical path will play a role in the evaluation of the path integral. We will expand  $q(t)$  about the classical path  $q_c(t)$ , which is defined by obeying

$$\ddot{q}_c + \omega^2 q_c = 0, \quad q_c(0) = q_i, \quad q_c(T) = q_f. \quad (1.42)$$

<sup>7</sup>The path integral for the hydrogen atom was famously solved by KLEINERT, HAGEN of course (developing work also with I.H. Duru).

So can we solve this differential equation? The best way to write the solution is the one which is the simplest to write down. All solutions include  $\sin \omega t$  and  $\cos \omega t$ , and one could write the solution as a linear combination of these and then work out the prefactors. However it is much nicer to choose instead  $\sin \omega t$  and  $\sin \omega(T - t)$ .<sup>8</sup> You can then write down the answer almost by inspection:

$$q_c(t) = \frac{1}{\sin \omega T} (q_f \sin \omega t + q_i \sin \omega(T - t)). \quad (1.43)$$

Clearly this satisfies the differential equation, and it is easy to verify that the boundary conditions are also satisfied, so we have solved (1.42).

The action for the particular path is given by

$$S[q_c] = \frac{1}{2} m \int_0^T dt (\dot{q}_c^2 - \omega^2 q_c^2). \quad (1.44)$$

Integrate this by parts

$$S[q_c] = \frac{1}{2} m [q_c \dot{q}_c]_0^T - \frac{1}{2} m \int_0^T dt q_c (\ddot{q}_c + \omega^2 q_c), \quad (1.45)$$

where the last integral vanishes since  $q_c$  obeys the equation of motion (1.42). We know what values  $q_c$  itself takes at  $t = 0$  and  $t = T$ :

$$S[q_c] = \frac{1}{2} m (q_f \dot{q}_c(T) - q_i \dot{q}_c(0)). \quad (1.46)$$

Now use the explicit solution for  $q_c$  to obtain

$$S[q_c] = m\omega \frac{-2q_f q_i + (q_f^2 + q_i^2) \cos \omega T}{2 \sin \omega T}. \quad (1.47)$$

Note as a consistency check that as  $\omega \rightarrow 0$ ,

$$S[q_c] \rightarrow \frac{1}{2} m \frac{(q_f - q_i)^2}{T}. \quad (1.48)$$

We can write a general path as

$$q(t) = q_c(t) + f(t), \quad f(0) = f(T) = 0. \quad (1.49)$$

For  $S[q]$  quadratic in  $q$  then

$$S[q] = S[q_c] + S[f] \quad (1.50)$$

is exact since as  $S[q]$  is stationary at  $q = q_c$ . (If you vary the action, you get the classical equations of motion - that is what the action came from.) That is, there is no linear term in  $f$ . This is analogous to expanding a function around a minimum, where the first terms in the expansion will be the value of the function at the minimum and a term quadratic in the deviation from the minimum.

We have also assumed that  $f$  is small, meaning that only paths close to the classical path will contribute to the integral. Furthermore, we can assume

$$d[q] = d[f], \quad (1.51)$$

which is something which is true for ordinary integrals, namely that  $d(x+a) = dx$  for a constant  $a$ . (This also makes sense in terms of the more formal definition (1.38) which we gave.) We can now write that in this particular example,

$$K(q, q_0; T) = \int d[q] e^{iS[q]} = e^{iS[q_c]} \int d[f] e^{iS[f]}. \quad (1.52)$$

---

<sup>8</sup>These are actually identical in the case  $\omega T = \pi n$  for some integer  $n$ . In this case, there is no classical solution unless  $q = (-1)^n q_0$ . This special case is ignored here.

Note that the integral is independent of  $q_0$  and  $q$ , thus all the dependence on the initial and final points is contained in the prefactor. There are various ways to derive the second factor; we use one which is potentially useful later on.

Expand  $f(t)$  in terms of a convenient complete set. We use a Fourier sine series for  $f$ :

$$f(t) = \sum_{n=1}^{\infty} a_n \sqrt{\frac{2}{T}} \sin \frac{n\pi t}{T}. \quad (1.53)$$

The sine functions form an orthonormal basis for functions vanishing at  $t = 0$  and  $t = T$ . We can write, integrating by parts, noting  $f(0) = f(T) = 0$  and using orthonormality,

$$S[f] = -\frac{1}{2}m \int_0^T dt f(\ddot{f} + \omega^2 f) = \frac{1}{2}m \sum_n a_n^2 \left( \frac{n^2\pi^2}{T^2} - \omega^2 \right). \quad (1.54)$$

We assume the relation

$$d[f] = C \prod_{n=1}^{\infty} da_n, \quad (1.55)$$

where  $C$  is a normalisation constant.<sup>9</sup> We are now in the position to express the integral in the form

$$\int d[f] e^{iS[f]} = C \prod_{n=1}^{\infty} \int da_n e^{i\frac{m}{2}a_n^2\left(\frac{n^2\pi^2}{T^2} - \omega^2\right)}. \quad (1.56)$$

The basic integral (solved by rotating the contour) here is

$$\int_{-\infty}^{\infty} dy e^{\frac{i}{2}\lambda y^2} = \sqrt{\frac{2\pi i}{\lambda}}. \quad (1.57)$$

It is convenient to write now

$$\int d[f] e^{iS[f]} = C_0 \prod_{n=1}^{\infty} \frac{1}{\sqrt{1 - \frac{\omega^2 T^2}{n^2 \pi^2}}}, \quad (1.58)$$

where we have absorbed constant factors like  $(\prod_{n=1}^{\infty} n)^{-1}$  into  $C_0$ . This factor is divergent, but does not depend on any of the critical parameters. (We will not talk about infinities appearing here.) In the free case  $\omega = 0$ , the product is equal to one and we are left with

$$C_0 = \sqrt{\frac{m}{2\pi iT}}, \quad (1.59)$$

which fixes the normalisation.

What can we say about this infinite product? It can be shown that

$$\prod_{n=1}^{\infty} \left( 1 - \frac{\omega^2 T^2}{n^2 \pi^2} \right) = \frac{\sin \omega T}{\omega T}. \quad (1.60)$$

(Note that both sides have the same zeros as functions of  $\omega T$ . Furthermore, they both go to one as  $\omega T \rightarrow 0$ . Several other observations show that both sides have the same behaviour and actually are identical.)

Ultimately,

$$\int d[f] e^{iS[f]} = \sqrt{\frac{m\omega}{2\pi i \sin \omega T}}, \quad (1.61)$$

<sup>9</sup>Thinking about the formal definition (1.38), if we consider  $t_r = \epsilon r$ , with  $\epsilon = T/(n+1)$ , then the transformation from  $\{f(t_r) : r = 1, \dots, N\}$  to  $\{a_n : n = 1, \dots, N\}$  is an orthogonal transformation so that  $\prod_r df(t_r) = \prod_n da_n$ .

which is a nice everyday function. The overall result, in all its glory, is the following:

$$K(q_f, q_i; T) = \sqrt{\frac{m\omega}{2\pi i \sin \omega T}} e^{im\omega \frac{(q_f^2 + q_i^2) \cos \omega T - 2q_f q_i}{2 \sin \omega T}}. \quad (1.62)$$

To check this, note that there are eigenfunctions  $|n\rangle$  of  $\hat{H}$  with

$$E_n = \left(n + \frac{1}{2}\right) \omega, \quad \hat{\mathbf{1}} = \sum_n |n\rangle\langle n|. \quad (1.63)$$

A formula which can be obtained by using standard quantum mechanics is

$$K(q_f, q_i; T) = \sum_n \psi_n(q_f) \psi_n^*(q_i) e^{-i(n + \frac{1}{2})\omega T}. \quad (1.64)$$

In the situation where  $T = -i\tau$ ,  $\tau \rightarrow \infty$ ,

$$2i \sin \omega T \rightarrow e^{\omega\tau}, \quad 2 \cos \omega T \rightarrow e^{\omega\tau}. \quad (1.65)$$

We find that

$$K(q_f, q_i; -i\tau) \stackrel{\tau \rightarrow \infty}{\sim} \sqrt{\frac{m\omega}{\pi}} e^{-\frac{1}{2}\omega\tau} e^{-\frac{1}{2}m\omega(q_f^2 + q_i^2)} = \psi_0(q) \psi_0^*(q_0) e^{-\frac{1}{2}\omega\tau}. \quad (1.66)$$

In this special case, the result obtained from the path integral calculation is consistent with standard quantum mechanics.

### 1.2.2 A Few Comments

- (i) Generally speaking, integrals of the form  $\int dx e^{i\lambda x^2}$  are rather ill-defined because they do not converge (absolutely). It is much better to consider integrals  $\int dx e^{-\lambda x^2}$  for  $\lambda > 0$ . The same thing happens with path integrals; note that

$$S[q] = \int_0^T dt \left( \frac{1}{2} m \dot{q}^2 - V(q) \right) \quad (1.67)$$

is normally a real quantity. But in order to obtain well-defined integrals, we can consider an analytic continuation of time

$$t \rightarrow -i\tau, \quad T \rightarrow -i\tau_1, \quad (1.68)$$

so that

$$\dot{q}^2 \rightarrow -\left(\frac{dq}{d\tau}\right)^2, \quad iS[q] \rightarrow -\int_0^{\tau_1} d\tau \left( \frac{1}{2} m \left(\frac{dq}{d\tau}\right)^2 + V(q) \right) \quad (1.69)$$

and the path integral becomes

$$\langle q | \exp(-\hat{H}\tau) | q_0 \rangle = \int d[q] e^{-\int_0^{\tau_1} d\tau \left( \frac{1}{2} m \left(\frac{dq}{d\tau}\right)^2 + V(q) \right)}. \quad (1.70)$$

The point about this is that the right-hand side integral has a rigorous definition for a wide class of potentials  $V$ , subject to the requirement that  $V$  is bounded from below.

In many contexts, one considers these integrals with analytic continuation. They first appeared in the context of BROWNIAN<sup>10</sup> motion.

- (ii) The path integral provides a method of making non-perturbative approximations; we will show this for the example of tunnelling. A widely known result from quantum mechanics is that particles can tunnel through a potential barrier. Consider a situation where we have a potential

---

<sup>10</sup>Brown, Robert (1773-1858)

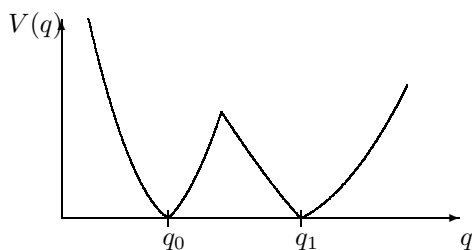

We want to calculate the amplitude to get from  $q_0$  at time  $t_0$  to  $q_1$  at time  $t_1$ , eventually taking the limits  $t_0 \rightarrow -\infty$  and  $t_1 \rightarrow \infty$ . So use the path integral to evaluate

$$\langle q_1 | \exp(-i\hat{H}(t_1 - t_0)) | q_0 \rangle. \quad (1.71)$$

One way of proceeding with these path integrals is to expand around a classical path

$$q(t) = q_c(t) + f(t), \quad (1.72)$$

where the classical path  $q_c(t)$  satisfies the classical equations and given boundary conditions. This method was used in the example above. In general, there will not necessarily be a classical path; here this is in the case when the total energy is smaller than the maximum of the potential between  $q_0$  and  $q_1$ . We make use of analytic continuation  $t \rightarrow -i\tau$ , such that

$$iS[q] = - \int_{\tau_0}^{\tau_1} d\tau \left( \frac{1}{2} m \left( \frac{dq}{d\tau} \right)^2 + V(q) \right), \quad (1.73)$$

and we are interested in the limit  $\tau_0 \rightarrow -\infty$ ,  $\tau_1 \rightarrow \infty$ . (Note that this actually means we choose a different contour in the complex plane to evaluate the integral. This is a method commonly used to evaluate integrals over analytic functions, and we have in fact already used it above. One makes use of this in the “method of steepest descents”, for example.) The classical equation for  $q_c(\tau)$  is now

$$-m \frac{d^2}{d\tau^2} q_c + V'(q_c) = 0, \quad (1.74)$$

which we integrate once to get

$$-\frac{1}{2} m \left( \frac{dq_c}{d\tau} \right)^2 + V(q_c) = E. \quad (1.75)$$

This is similar to classical mechanics, but with one sign flipped because of our funny change in time. We want a situation in which as  $\tau \rightarrow \pm\infty$ ,  $q(\tau) \rightarrow q_0$  or  $q(\tau) \rightarrow q_1$ , where  $V(q_0) = V(q_1) = 0$ . But if it is smoothly going to these points we must also have

$$\left. \frac{dq}{d\tau} \right|_{q=q_0} = \left. \frac{dq}{d\tau} \right|_{q=q_1} = 0 \quad \rightsquigarrow \quad E = 0. \quad (1.76)$$

In this situation, we can actually solve this, assuming  $q_1 > q_0$  and therefore taking the positive square root to get

$$\frac{dq_c}{d\tau} = \sqrt{\frac{2V(q_c)}{m}}. \quad (1.77)$$

Now substitute this in to evaluate  $iS[q_c]$ :

$$iS[q_c] = -2 \int_{-\infty}^{\infty} d\tau V(q_c) = - \int_{q_0}^{q_1} dq \sqrt{2mV(q)}, \quad (1.78)$$

because  $d\tau = \frac{dq \sqrt{m}}{\sqrt{2V(q)}}$  for this solution.



As we have seen in the case of the harmonic oscillator, the dependence of the path integral on the initial and final points is contained in  $e^{iS[q_c]}$ , so the tunnelling amplitude will be proportional to

$$E^{-\int_{q_0}^{q_1} dq \sqrt{2mV(q)}}. \quad (1.79)$$

This is an exponential suppression, which is a real quantity, but non-zero in all cases. (It is known as the GAMOW<sup>11</sup> factor.)

The path integral calculation gives the same result as WKB, for example, in a relatively simple way.

(iii) In general, there is no unique correspondence

$$H(q, p) \longrightarrow \hat{H} = H(\hat{q}, \hat{p}) \quad (1.80)$$

in quantum mechanics, because a product  $pq$  can be replaced by

$$pq \longrightarrow \begin{cases} \hat{p}\hat{q} \\ \hat{q}\hat{p} \end{cases}, \quad (1.81)$$

and these are not equal (since  $[\hat{q}, \hat{p}] \neq 0$ ). In many problems there are ways to resolve this ambiguity, but it is still there. This is reflected in the path integral, although this is far from obvious. There are more complicated problems where different discretisations of the path integral will give different answers. Although we will not be very concerned with this problem, it is worth bearing in mind it exists.

In due course, we are going to apply the ideas of path integrals to field theories. But first let us do some calculations which will be useful later on.

### 1.3 GAUSSIAN Integrals and Extensions Over Multi-Dimensional Coordinates

Consider a set of coordinates, represented by a column vector

$$\underline{x} = (x_1, \dots, x_n)^T \in \mathbb{R}^n, \quad (1.82)$$

and define a scalar product

$$\underline{x} \cdot \underline{x}' = \underline{x}^T \underline{x}' = \sum_{i=1}^n x_i x'_i. \quad (1.83)$$

Let  $\underline{A}$  be a  $n \times n$  symmetric positive definite matrix and consider the GAUSSIAN<sup>12</sup> integral

$$Z_{\underline{A}} = \int d^n x e^{-\frac{1}{2} \underline{x} \cdot \underline{A} \underline{x}} \quad (1.84)$$

This kind of integral is essentially equivalent to free field theory, as will become apparent in due course.

Its evaluation is quite simple: note that there is an orthogonal matrix  $\underline{U}$  ( $|\det \underline{U}| = 1$ ) such that

$$\underline{U} \underline{A} \underline{U}^T = \underline{D} = \begin{pmatrix} \lambda_1 & & 0 \\ & \ddots & \\ 0 & & \lambda_n \end{pmatrix}, \quad (1.85)$$

where  $\lambda_i > 0$  for all  $i = 1, \dots, n$ . It is now quite straightforward to compute the integral with a suitable change of variable; namely let

$$\underline{x}' = \underline{U} \underline{x}, \quad d^n x = d^n x' \quad (1.86)$$

<sup>11</sup>Gamow, George (1904-1968)

<sup>12</sup>Gauß, Carl Friedrich (1777-1855)

$$\Rightarrow Z_{\underline{A}} = \int d^n x' e^{-\frac{1}{2} \underline{x}' \cdot \underline{D} \underline{x}'} = \prod_{i=1}^n \int dx'_i e^{-\frac{1}{2} \lambda_i x_i'^2}, \quad (1.87)$$

so the integral factorises because of

$$\underline{x}' \cdot \underline{D} \underline{x}' = \sum_{i=1}^n \lambda_i x_i'^2. \quad (1.88)$$

The generic integral is of the form

$$\int dx e^{-\frac{1}{2} \lambda x^2} = \sqrt{\frac{2\pi}{\lambda}}. \quad (1.89)$$

So now we know the answer

$$\boxed{Z_{\underline{A}} = \prod_{i=1}^n \sqrt{\frac{2\pi}{\lambda_i}} = \frac{(2\pi)^{\frac{n}{2}}}{\sqrt{\det \underline{A}}}.} \quad (1.90)$$

An important generalisation is to the complex case, when we have a column vector

$$\underline{z} = (z_1, \dots, z_n)^T \in \mathbb{C}^n, \quad (1.91)$$

and define a scalar product

$$\bar{\underline{z}} \cdot \underline{z}' = \underline{z}^\dagger \underline{z}' = \sum_{i=1}^n z_i^* z'_i. \quad (1.92)$$

In general, when  $\underline{z} = \underline{x} + iy$ , we define

$$d^{2n} z = d^n x d^n y. \quad (1.93)$$

Let us take  $\underline{B}$  to be a HERMITIAN<sup>13</sup> matrix with positive (real) eigenvalues and consider the GAUSSIAN integral

$$Z_{\underline{B}} = \int d^{2n} z e^{-\bar{\underline{z}} \cdot \underline{B} \underline{z}}. \quad (1.94)$$

In this case, there is a unitary matrix  $\underline{U}$  such that

$$\underline{U} \underline{B} \underline{U}^\dagger = \underline{D} = \begin{pmatrix} \lambda_1 & & 0 \\ & \ddots & \\ 0 & & \lambda_n \end{pmatrix}, \quad (1.95)$$

where again all  $\lambda_i > 0$ . Now the same trick as before applies:

$$\underline{z}' = \underline{U} \underline{z}, \quad d^{2n} z = d^{2n} z', \quad (1.96)$$

and

$$\bar{\underline{z}}' \cdot \underline{D} \underline{z}' = \sum_{i=1}^n \lambda_i |z'_i|^2. \quad (1.97)$$

The basic integral here is

$$\int d^2 z e^{-\lambda |z|^2} = \int dx dy e^{-\lambda(x^2+y^2)} = \frac{\pi}{\lambda}. \quad (1.98)$$

(Note that  $\int dz$  usually denotes line integrals, where here we integrate over the whole complex plane.) The result in this case is

$$\boxed{Z_{\underline{B}} = \frac{\pi^n}{\det \underline{B}}}, \quad (1.99)$$

which should be compared to (1.90) - note that in this case the determinant of the matrix appears instead of its square root.

<sup>13</sup>Hermite, Charles (1822-1901)

As a brief comment, let us consider an  $i$  in the exponent

$$Z_{\underline{A}} = \int d^n x e^{-\frac{i}{2} \underline{x} \cdot \underline{A} \underline{x}} = \left( \frac{2\pi}{i} \right)^{\frac{n}{2}} (\det \underline{A})^{-\frac{1}{2}}, \quad (1.100)$$

where we have analytically continued each  $x$  integral into the complex plane.

Now consider the extension to a linear term in the exponent

$$Z_{\underline{A}, \underline{b}} = \int d^n x e^{-\frac{i}{2} \underline{x} \cdot \underline{A} \underline{x} + \underline{b} \cdot \underline{x}}. \quad (1.101)$$

We can reduce this one to the previous case in the following way. Note that we can write

$$\frac{1}{2} \underline{x} \cdot \underline{A} \underline{x} - \underline{b} \cdot \underline{x} = \frac{1}{2} \underline{x}' \cdot \underline{A} \underline{x}' - \frac{1}{2} \underline{b} \cdot \underline{A}^{-1} \underline{b}, \quad (1.102)$$

where

$$\underline{x}' = \underline{x} - \underline{A}^{-1} \underline{b}. \quad (1.103)$$

(Since the eigenvalues of  $\underline{A}$  are assumed to be positive, there is no problem whatsoever in defining the inverse.) With the result (1.90) obtained above, we then get

$$Z_{\underline{A}, \underline{b}} = e^{\frac{1}{2} \underline{b} \cdot \underline{A}^{-1} \underline{b}} \cdot \int d^n x' e^{-\frac{i}{2} \underline{x}' \cdot \underline{A} \underline{x}'} = e^{\frac{1}{2} \underline{b} \cdot \underline{A}^{-1} \underline{b}} \cdot \frac{(2\pi)^{\frac{n}{2}}}{\sqrt{\det \underline{A}}}. \quad (1.104)$$

The analogous formula in the complex case is

$$Z_{\underline{B}, \underline{b}} = \int d^{2n} z e^{-\bar{z} \cdot \underline{B} z + \bar{b} \cdot z + \bar{z} \cdot \underline{b}} = e^{\bar{b} \cdot \underline{B}^{-1} \underline{b}} \cdot Z_{\underline{B}}. \quad (1.105)$$

Next we will consider how integrals can be expanded and how these expansions can be represented by pictures. This will lead to FEYNMAN graphs.

We will discuss things which are called *expectation values*:

$$\langle f(\underline{x}) \rangle = \frac{1}{Z_{\underline{A}, 0}} \int d^n x f(\underline{x}) e^{-\frac{i}{2} \underline{x} \cdot \underline{A} \underline{x}}. \quad (1.106)$$

In general we are interested in functions which are polynomial in some sense. We will usually assume that all relevant functions may be expanded in a power series, so that we can restrict our considerations to polynomial functions (by linearity). Note that by definition,

$$\langle 1 \rangle = 1. \quad (1.107)$$

The major trick we are going to use here is the observation that

$$f(\underline{x}) = f \left( \frac{\partial}{\partial \underline{b}} \right) e^{\underline{b} \cdot \underline{x}} \Big|_{\underline{b}=0}, \quad (1.108)$$

where

$$\frac{\partial}{\partial \underline{b}} \equiv \nabla_{\underline{b}} = \left( \frac{\partial}{\partial b_1}, \dots, \frac{\partial}{\partial b_n} \right). \quad (1.109)$$

The observation then follows directly from

$$\frac{\partial}{\partial \underline{b}} e^{\underline{b} \cdot \underline{x}} = \underline{x} e^{\underline{b} \cdot \underline{x}}. \quad (1.110)$$

It follows therefore that we have a trick for evaluating the expectation value  $\langle f(\underline{x}) \rangle$ . We can write

$$\langle f(\underline{x}) \rangle = \frac{1}{Z_{\underline{A}, 0}} \int d^n x f \left( \frac{\partial}{\partial \underline{b}} \right) e^{-\frac{i}{2} \underline{x} \cdot \underline{A} \underline{x} + \underline{b} \cdot \underline{x}} \Big|_{\underline{b}=0}, \quad (1.111)$$

and take  $f$  outside the integral:

$$\langle f(\underline{x}) \rangle = \frac{1}{Z_{\underline{A}, 0}} f \left( \frac{\partial}{\partial \underline{b}} \right) Z_{\underline{A}, \underline{b}} \Big|_{\underline{b}=0}. \quad (1.112)$$

We can simplify this straight away by substituting in our previous result (1.104)

$$\boxed{\langle f(\underline{x}) \rangle = f \left( \frac{\partial}{\partial \underline{b}} \right) e^{\frac{1}{2} \underline{b} \cdot \underline{A}^{-1} \underline{b}} \Big|_{\underline{b}=\underline{0}}.} \quad (1.113)$$

This is a very convenient way for working out these expectations.

Let us consider some particular cases:

$$\langle x_i \rangle = 0, \quad (1.114)$$

$$\langle x_i x_j \rangle = \frac{\partial}{\partial b_i} (\underline{A}^{-1} \underline{b})_j e^{\frac{1}{2} \underline{b} \cdot \underline{A}^{-1} \underline{b}} \Big|_{\underline{b}=\underline{0}} = A_{ij}^{-1}. \quad (1.115)$$

We introduce the notation that a component of the inverse of the matrix  $\underline{A}$  is represented by a line, whose ends are labelled by  $i$  and  $j$ :

$$i \text{ --- } j$$

A little calculation will show that

$$\langle x_{i_1} x_{i_2} \dots x_{i_n} \rangle = 0 \quad \text{for odd } n, \quad (1.116)$$

and also

$$\langle x_i x_j x_k x_l \rangle = A_{ij}^{-1} A_{kl}^{-1} + A_{ik}^{-1} A_{jl}^{-1} + A_{il}^{-1} A_{jk}^{-1}. \quad (1.117)$$

(Note that  $A_{ij}^{-1}$  denotes the component  $ij$  of the matrix  $\underline{A}^{-1}$ , and not the inverse of the component  $ij$  of the matrix  $\underline{A}$ ,  $\underline{A}^{-1}$  is symmetric since  $\underline{A}$  is.)

Draw a picture for this case:

$$\begin{array}{ccc} i \text{ --- } j & i \quad | & j \\ k \text{ --- } l & k \quad | & l \end{array} \quad \begin{array}{c} i \quad | \\ | \\ k \quad | \end{array} \quad \begin{array}{c} j \\ | \\ l \end{array} \quad \begin{array}{c} i \quad \diagdown \quad \diagup \\ \quad \quad \quad \quad \quad \\ k \quad \diagup \quad \diagdown \\ \quad \quad \quad \quad \quad \\ l \end{array}$$

We can give a diagrammatic picture of how these things work.

The second result can be obtained in a slightly different way: Consider

$$A_{ik} \langle x_k x_j \rangle = \frac{1}{Z_{\underline{A}, \underline{0}}} \int d^n x A_{ik} x_k x_j e^{-\frac{1}{2} \underline{x} \cdot \underline{A} \underline{x}} = -\frac{1}{Z_{\underline{A}, \underline{0}}} \int d^n x x_j \frac{\partial}{\partial x_i} \left( e^{-\frac{1}{2} \underline{x} \cdot \underline{A} \underline{x}} \right). \quad (1.118)$$

Integration by parts gives

$$A_{ik} \langle x_k x_j \rangle = \frac{1}{Z_{\underline{A}, \underline{0}}} \int d^n x \left( \frac{\partial}{\partial x_i} x_j \right) e^{-\frac{1}{2} \underline{x} \cdot \underline{A} \underline{x}} = \delta_{ij}. \quad (1.119)$$

So the matrix  $A_{ik}$  acting on  $\langle x_k x_j \rangle$  gives the identity, which means that (because of symmetry)

$$\langle x_i x_j \rangle = A_{ij}^{-1}. \quad (1.120)$$

The complex case contains no essential new ideas as compared to the real case, and is summarised here: Let  $\underline{B}$  be HERMITIAN, then

$$\langle f(\underline{z}, \underline{\bar{z}}) \rangle := \frac{1}{Z_{\underline{B}, \underline{0}}} \int d^{2n} z f(\underline{z}, \underline{\bar{z}}) e^{-\underline{\bar{z}} \cdot \underline{B} \underline{z}} = \frac{1}{Z_{\underline{B}, \underline{0}}} f \left( \frac{\partial}{\partial \underline{b}}, \frac{\partial}{\partial \underline{b}} \right) Z_{\underline{B}, \underline{b}} \Big|_{\underline{b}=\underline{0}}. \quad (1.121)$$

One finds that

$$\langle z_i \bar{z}_j \rangle = B_{ij}^{-1}, \quad (1.122)$$

which is no longer necessarily symmetric in  $i$  and  $j$ . Therefore we denote this by

$$i \longrightarrow j$$

i.e. we add an arrow to denote which index comes first.

Exercise: Obtain this result by showing that

$$B_{ik} \langle z_k \bar{z}_j \rangle = \delta_{ij} = \langle z_i \bar{z}_k \rangle B_{kj}. \quad (1.123)$$

Generally, to visualise  $\langle x_{i_1} \dots x_{i_{2n}} \rangle$ , we draw  $n$  lines linking different points. One can write down diagrammatically what an expectation value is by drawing more and more lines.

## 1.4 Non-GAUSSIAN Integrals and Perturbation Expansions

These integrals will correspond to *interacting field theory* (whereas the previous GAUSSIAN integrals corresponded to free field theory). The basic integral in this case is

$$Z = \frac{1}{Z_{A,0}} \int d^n x e^{-\frac{1}{2} \underline{x} \cdot A \underline{x} + \underline{b} \cdot \underline{x} - V(\underline{x})}, \quad (1.124)$$

where the prefactor conveniently ensures that  $Z|_{\underline{b}=0, V=0} = 1$ . We require that the real function  $V(\underline{x})$  is bounded below, and also  $V(\underline{0}) = 0$ . Now we use the same trick as before:

$$Z = e^{-V(\frac{\partial}{\partial \underline{b}})} \frac{1}{Z_{A,0}} \int d^n x e^{-\frac{1}{2} \underline{x} \cdot A \underline{x} + \underline{b} \cdot \underline{x}}. \quad (1.125)$$

This is very formal, but for finite integrals there is no real problem in writing down this expression. Substituting in, we get

$$Z = e^{-V(\frac{\partial}{\partial \underline{b}})} e^{\frac{1}{2} \underline{b} \cdot A^{-1} \underline{b}}. \quad (1.126)$$

We can evaluate this by expanding  $e^{-V(\frac{\partial}{\partial \underline{b}})}$ . This will give the rise to a *perturbation expansion*. However, there is a slightly alternative way of doing it which from some point of view makes the manipulations a little easier.  $V$  may be a complicated function.

**Lemma**

$$G\left(\frac{\partial}{\partial \underline{b}}\right) F(\underline{b}) = F\left(\frac{\partial}{\partial \underline{x}}\right) G(\underline{x}) e^{\underline{x} \cdot \underline{b}} \Big|_{\underline{x}=\underline{0}}. \quad (1.127)$$

**Proof**

We will show this for a special case: Let  $G(\underline{x}) = e^{\underline{x} \cdot \underline{\alpha}}$ ,  $F(\underline{b}) = e^{\underline{b} \cdot \underline{\alpha}}$ . Then the left-hand side is

$$G\left(\frac{\partial}{\partial \underline{b}}\right) F(\underline{b}) = e^{\frac{\partial}{\partial \underline{b}} \cdot \underline{\alpha}} F(\underline{b}) = F(\underline{b} + \underline{\alpha}) = e^{\underline{b} \cdot (\underline{b} + \underline{\alpha})}. \quad (1.128)$$

Let us attempt to consider the right-hand side:

$$f\left(\frac{\partial}{\partial \underline{x}}\right) G(\underline{x}) e^{\underline{x} \cdot \underline{b}} \Big|_{\underline{x}=\underline{0}} = e^{\underline{b} \cdot \frac{\partial}{\partial \underline{x}}} e^{\underline{x} \cdot (\underline{\alpha} + \underline{b})} \Big|_{\underline{x}=\underline{0}} = e^{(\underline{x} + \underline{b}) \cdot (\underline{\alpha} + \underline{b})} \Big|_{\underline{x}=\underline{0}} = e^{\underline{b} \cdot (\underline{\alpha} + \underline{b})}. \quad (1.129)$$

The result is then true for any  $F$  and  $G$  as one may express  $F$  and  $G$  as a Fourier series.  $\square$

Let us apply this to the expression for  $Z$ , so that

$$\boxed{Z = e^{\frac{1}{2} \frac{\partial}{\partial \underline{x}} \cdot A^{-1} \frac{\partial}{\partial \underline{x}} e^{-V(\underline{x}) + \underline{b} \cdot \underline{x}} \Big|_{\underline{x}=\underline{0}}}. \quad (1.130)$$

We get a perturbative expansion by expanding both exponentials, setting for simplicity  $\underline{b} = \underline{0}$ . We use the notation

$$V_{i_1 i_2 \dots i_k} = \frac{\partial}{\partial x_{i_1}} \frac{\partial}{\partial x_{i_2}} \dots \frac{\partial}{\partial x_{i_k}} V(\underline{x}) \Big|_{\underline{x}=\underline{0}}, \quad (1.131)$$

where  $i_1, \dots, i_k \in \{1, \dots, n\}$ . The first few terms of the expansion are, assuming that  $V(\underline{0}) = V_i(\underline{0}) = 0$ ,

$$\begin{aligned} Z = 1 &- \frac{1}{2} A_{ij}^{-1} V_{ij} - \frac{1}{8} A_{ij}^{-1} A_{kl}^{-1} V_{ijkl} + \frac{1}{8} A_{ij}^{-1} V_{ij} A_{kl}^{-1} V_{kl} + \frac{1}{4} V_{ij} A_{ik}^{-1} A_{jl}^{-1} V_{kl} \\ &+ \frac{1}{8} V_{ijk} A_{ij}^{-1} A_{kl}^{-1} A_{mn}^{-1} V_{lmn} + \frac{1}{12} V_{ijk} A_{il}^{-1} A_{jm}^{-1} A_{kn}^{-1} V_{lmn} + \dots \end{aligned} \quad (1.132)$$

These expressions are not very transparent; proliferation of indices makes it hard to see what is going on.

Diagrammatic interpretation:

We represent  $A_{ij}^{-1}$  by a line joining the points  $i$  and  $j$ , as before, and  $-V_{i_1 i_2 \dots i_k}$  by a vertex joining  $k$  lines, e.g.

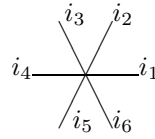

Then we can associate the terms shown above in the expansion of  $Z - 1$  with the diagrams

$$-\frac{1}{2} \text{circle} - \frac{1}{8} \text{two circles} + \frac{1}{8} \text{circle with dot} + \frac{1}{4} \text{circle with two dots} + \frac{1}{8} \text{two circles} + \frac{1}{12} \text{circle with line} + \dots$$

Diagrams like the third one are called *disconnected*. In general, all these diagrams are called *vacuum diagrams*, since there are no external lines. Check the following, known as EULER'S<sup>14</sup> formula, holds for all connected diagrams:

$$\boxed{L = I - V + 1}, \tag{1.133}$$

where  $L$  is the number of closed loops<sup>15</sup>,  $I$  is the number of internal lines and  $V$  is the number of vertices. To demonstrate consider the subgraph where the  $V$  vertices are linked by just  $V - 1$  lines to create a minimal connected tree graph (this may of course not be unique). Then add the remaining  $I - V + 1$  lines between the various vertices to restore the complete graph; each addition creates a new loop.

Let us summarise the FEYNMAN rules for diagrammatic expressions of integrals of this type:

- Lines, with end points labelled by  $i$  and  $j$ , represent  $A_{ij}^{-1}$ .
- Vertices represent  $-V_{i_1 \dots i_k}$ .
- Contract all indices.

Now take the general case  $\underline{b} \neq \underline{0}$ ; let us see how this is modified. We can now always maintain  $V_i(\underline{0}) = 0$  for all  $i$  by redefining  $V(\underline{x})$ , absorbing all contributions into  $\underline{b}$ . We introduce external lines



associated with one  $b_i$ . The first terms in the expansion which will now also contribute are

$$\frac{1}{2} b_i A_{ij}^{-1} b_j - \frac{1}{6} b_i b_j b_k A_{il}^{-1} A_{jm}^{-1} A_{kn}^{-1} V_{lmn} - \frac{1}{2} b_i b_j A_{ik}^{-1} A_{jl}^{-1} V_{kl} + \dots \tag{1.134}$$

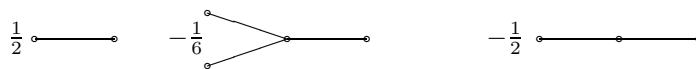

<sup>14</sup>Euler, Leonhard (1707-1783)

<sup>15</sup>For a graph which can be drawn in the plane, this means the number of 'faces', or regions separated by edges. In general, the definition is slightly harder to see geometrically. The most natural way to think of this for our purposes is as follows: imagine some conserved number (like momentum) is flowing through the graph; then if you are told how much goes in/out at the external points, you can deduce something about flow within the graph. However, an arbitrary amount can flow around a circle in the graph. The number of independent such amounts we will later think of as the number of loops.

In all of these expressions, all lines are attached to external lines, there are no superfluous indices. Of course, the complexity increases quite dramatically as one proceeds. Diagrams such as those just described which have no loops are called *tree* diagrams vacuum diagrams always have loops). A one loop diagram with two external lines is

$$\dots + \frac{1}{4} b_i b_j A_{ik}^{-1} A_{jl}^{-1} V_{kmn} V_{lpq} A_{mp}^{-1} A_{nq}^{-1} + \dots \quad (1.135)$$



For each diagram it is necessary to also include an associated coefficient  $\frac{1}{S}$ , where  $S$  is termed the *symmetry factor* of the diagram. For any graph  $\Gamma$  there is a symmetry or automorphism group  $\mathcal{S}_\Gamma$  which is the group of permutations of lines and vertices which leave the graph invariant. A graph  $\Gamma$  consists of vertices  $\{v\}$  and lines  $\{l\}$  linking vertices, for  $\sigma \in \mathcal{S}_\Gamma$  we require that for all  $l$  linking  $v$  to  $v'$  then  $\sigma(l)$  links  $\sigma(v)$  to  $\sigma(v')$  or, if the lines have no direction,  $\sigma(v')$  to  $\sigma(v)$ .  $S$  is the order of  $\mathcal{S}_\Gamma$ ,  $S = |\mathcal{S}_\Gamma|$ , so that it is the number of ways lines and vertices may be permuted leaving the diagram invariant. External lines with labels such a momenta cannot be permuted as this would not leave the graph invariant. If the graph has only vertices linked by single lines then the symmetry group is found by considering just permutations of the vertices which leave it invariant. For the graphs representing the expansion of  $Z$  it may also be defined as the group formed by non trivial permutations of the indices associated with the vertices  $V_{ij} = V_{(ij)}, V_{ijk} = V_{(ijk)}, \dots$  which leave the expression corresponding to the diagram unchanged (trivial permutations are those which are just a different relabelling of all the indices, which are just summed over dummy variables). For instance, the second diagram in the sum above has  $S = 3! = 6$ , since all three lines can be commuted. The last diagram has  $S = 4$ , since both external lines can be commuted, as well as the lines in the middle. It takes some experience to work these factors out in practice, and it is always worth trying to check the results, for it is not very difficult to get these things wrong.

To actually prove that the coefficient is indeed  $\frac{1}{S}$  is less straightforward. Suppose the graph is a collection  $p_n$   $n$ -vertices, at which  $n$  identical lines are incident. External lines can be regarded as vertices with  $n = 1$ . Each vertex has an associated  $1/n!$  from the expansion of  $V$  and also  $1/p_n!$  from the expansion of the exponential. Label the graph uniquely by giving all lines a unique label. If we count the number of ways of forming a particular labelled graph then there is an  $n!$  for each  $n$ -vertex, from the  $n!$  ways of coupling the labelled lines to each  $n$ -vertex, and also a  $p_n!$  from permuting all the  $n$ -vertices. These factors then cancel the  $1/n!$  and  $1/p_n!$  factors. However the Feynman integrals correspond to unlabelled graphs, each of which generates  $S_\Gamma$  unique labelled graphs so it is necessary to introduce a factor  $1/S$  which may be regarded as arising from an incomplete cancellation of the  $1/n!$  and  $1/p_n!$  factors.

We now consider a couple of special cases, just to verify how this works:

Let  $\underline{b} = \underline{0}$  and  $V_{i_1 \dots i_k} = 0$  for  $k \geq 3$ . If we represent the second derivatives of  $V$  by an  $(n \times n)$  matrix  $\underline{V}''$ , the result you can write is

$$Z = 1 - \frac{1}{2} \text{tr}(\underline{A}^{-1} \underline{V}'') + \frac{1}{8} (\text{tr}(\underline{A}^{-1} \underline{V}''))^2 + \frac{1}{4} \text{tr}(\underline{A}^{-1} \underline{V}'' \underline{A}^{-1} \underline{V}'') + \dots, \quad (1.136)$$

where  $\text{tr}(\underline{A}^{-1} \underline{V}'') = A_{ij}^{-1} V_{ji}''$ , of course. But the problem can also be solved exactly, with the exact result being given by

$$Z = \frac{1}{Z_{\underline{A}}} \int d^n x e^{-\frac{1}{2} \underline{x} \cdot (\underline{A} + \underline{V}'') \underline{x}} = \frac{1}{Z_{\underline{A}}} (2\pi)^{\frac{n}{2}} (\det(\underline{A} + \underline{V}''))^{-\frac{1}{2}} \quad (1.137)$$

$$= (\det \underline{A}^{-1} \cdot \det(\underline{A} + \underline{V}''))^{-\frac{1}{2}} = (\det(I + \underline{A}^{-1} \underline{V}''))^{-\frac{1}{2}}, \quad (1.138)$$

where  $(\det \underline{M})^{-1} = \det(\underline{M}^{-1})$  and  $\det(\underline{M} \cdot \underline{N}) = \det \underline{M} \cdot \det \underline{N}$ . was used.

For any (diagonalisable) matrix  $\underline{M}$ , we have the following identity

$$\log \det \underline{M} = \text{tr} \log \underline{M}, \quad (1.139)$$

which follows from the observation that the determinant of a matrix is the product of its eigenvalues and a logarithm of a product is the sum of logarithms. For an eigenvalue  $\lambda_i = 0$ , the identity becomes singular.

We use this identity and the expansion  $\log(1+x) = x - \frac{x^2}{2} + \dots$  to obtain an expansion for  $Z$ :

$$\begin{aligned} Z &= e^{-\frac{1}{2} \log \det(I + \underline{A}^{-1} \underline{V}'')} = e^{-\frac{1}{2} \text{tr} \log(I + \underline{A}^{-1} \underline{V}'')} \\ &= e^{-\frac{1}{2} \text{tr}(\underline{A}^{-1} \underline{V}'' + \frac{1}{4}(\underline{A}^{-1} \underline{V}'' \underline{A}^{-1} \underline{V}'') + \dots)} \\ &= 1 - \frac{1}{2} \text{tr}(\underline{A}^{-1} \underline{V}'') + \frac{1}{8} (\text{tr}(\underline{A}^{-1} \underline{V}''))^2 + \frac{1}{4} \text{tr}(\underline{A}^{-1} \underline{V}'' \underline{A}^{-1} \underline{V}'') + \dots, \end{aligned} \quad (1.140)$$

so we have reproduced the previous result.

Note that we can also consider  $\underline{b} \neq \underline{0}$ , where only the second derivatives of  $V$  are non-zero (as before). We will get additional terms (only second order in  $b$ )

$$\frac{1}{2} \circ \text{---} \circ + \frac{1}{2} \circ \text{---} \circ \text{---} \circ + \frac{1}{2} \circ \text{---} \circ \text{---} \circ \text{---} \circ \dots$$

corresponding to

$$\frac{1}{2} b_i (A_{ij}^{-1} - A_{ik}^{-1} V_{lk}'' A_{lj}^{-1} + \dots) b_j = \frac{1}{2} b_i (A + V'')_{ij}^{-1} b_j, \quad (1.141)$$

where the expansion arises from a geometric series and the final line is an exact result. The series must reproduce what we would expect; recall (1.104)

$$Z_{\underline{A}, \underline{b}} = e^{\frac{1}{2} \underline{b} \cdot \underline{A}^{-1} \underline{b}} \frac{(2\pi)^{\frac{n}{2}}}{\sqrt{\det \underline{A}}}.$$

To draw a connection to field theory, we need to consider the following integral with a complex exponent:

$$\int d^n x e^{-i(\frac{1}{2} x_i A_{ij} x_j + V(\underline{x}))}. \quad (1.142)$$

In this case the FEYNMAN rules are slightly modified, namely that

- Lines, with end points labelled by  $i$  and  $j$ , represent  $-iA_{ij}^{-1}$ .
- Vertices represent  $-iV_{i_1 \dots i_k}$ .

The symmetry factors are unchanged.

Feynman diagrams provide a very convenient shorthand for expressing expansions of integrals of the exponential form which defines  $Z$ . The expansion makes sense only when  $V$  is small, of course, and in general gives only an asymptotic series, the actual radius of convergence is zero.

Up to this point we have played around with toy problems, path integrals in standard quantum mechanics and calculated some integrals. The motivation for this is to extend all these ideas to quantum fields, which is what we will now do.



## 2 Functional Methods in Quantum Field Theory

### 2.1 Free Scalar Field Theory

We usually have a scalar field

$$\phi(x) = \phi(\vec{x}, t). \quad (2.1)$$

Our convention for the MINKOWSKI<sup>16</sup> metric is

$$\eta_{\mu\nu} = \text{diag}(-1, +1, \dots, +1). \quad (2.2)$$

The LAGRANGIAN density for free field theory is given by

$$\mathcal{L}_0 = -\frac{1}{2}\partial^\mu\phi\partial_\mu\phi - \frac{1}{2}m^2\phi^2 = \frac{1}{2}\dot{\phi}^2 - \frac{1}{2}(\vec{\nabla}\phi)^2 - \frac{1}{2}m^2\phi^2, \quad (2.3)$$

which leads to the action

$$S_0[\phi] = \int d^d x \mathcal{L}_0 = - \int d^d x \left( \frac{1}{2}\phi(x)\Delta\phi(x) \right), \quad (2.4)$$

by integration by parts, where

$$\Delta \equiv -\square + m^2 = \frac{\partial^2}{\partial t^2} - \nabla^2 + m^2, \quad (2.5)$$

is the KLEIN-GORDON operator. Note that we take the number of dimensions to be  $d$ , which can generally take any value. The classical equation of motion is

$$\Delta\phi = 0, \quad (2.6)$$

the KLEIN-GORDON<sup>17</sup> equation. It was actually discovered by SCHRÖDINGER, but because of problems arising in standard quantum mechanics he then tried to find a differential equation which was first order in time. However, it is perfectly o.k. when you move to quantum field theory.

We can define a quantum field theory, instead of by using the classical approach of going to the HAMILTONIAN formalism and then imposing certain commutation relations for fields and conjugate momenta, through a functional integral:

$$Z_0[J] = \int d[\phi] e^{iS_0[\phi] + i \int d^d x J(x)\phi(x)}. \quad (2.7)$$

Square brackets, as usually, denote that  $Z_0$  is a functional, depending on a function  $J(x)$ .  $J$  is sometimes referred to as a *source*, like an external current in classical electrodynamics. Formally,

$$d[\phi] = \prod_x d\phi(x). \quad (2.8)$$

We sort of define it in the following way

$$\prod_x d\phi(x) \approx \lim_{a \rightarrow 0} \prod_i d\phi(x_i), \quad (2.9)$$

where the points  $x_i$  belong to a lattice of size  $a$ . One will first consider a finite volume for this lattice, then take the limit of infinite volume. This is the same approach as in one-dimensional quantum mechanics, where we divided a time interval into smaller intervals, taking the limit of the size of the steps going to zero.

We introduce the idea of a *functional derivative*, defined by the essential rule

$$\frac{\delta J(y)}{\delta J(x)} = \delta^d(x - y), \quad (2.10)$$

<sup>16</sup>Minkowski, Hermann (1864-1909)

<sup>17</sup>Klein, Oskar (1894-1977), Gordon, Walter (1893-1939)

together with the usual LEIBNIZ and chain rules for differentiation. This means that for instance,

$$\frac{\delta}{\delta J(x)} e^{i \int d^d x J(x)\phi(x)} = i\phi(x) e^{i \int d^d x J(x)\phi(x)}. \quad (2.11)$$

Note that

$$\frac{\delta}{\delta\phi(x)} S_0[\phi] = -\Delta\phi(x), \quad (2.12)$$

since  $\delta S_0[\phi] = -\int d^d x \delta\phi(x)\Delta\phi(x)$ .

In order to evaluate the functional integral, we replace

$$S_0[\phi] + \int d^d x J(x)\phi(x) = S_0[\phi'] + \frac{1}{2} \int d^d x J(x)\Delta^{-1}J(x), \quad (2.13)$$

where  $\phi'(x) = \phi(x) - \Delta^{-1}J(x)$ ; note that then

$$\begin{aligned} S_0[\phi'] &= -\frac{1}{2} \int d^d x (\phi(x)\Delta\phi(x) - \phi(x)J(x) + J(x)\Delta^{-1}J(x) - \Delta^{-1}J(x)\Delta\phi(x)) \\ &= -\frac{1}{2} \int d^d x (\phi(x)\Delta\phi(x) - 2\phi(x)J(x) + J(x)\Delta^{-1}J(x)). \end{aligned} \quad (2.14)$$

If we choose the normalisation

$$Z_0[0] = \int d[\phi] e^{iS_0[\phi]} = 1, \quad (2.15)$$

we would then have

$$Z_0[J] = e^{\frac{1}{2}i \int d^d x J(x)\Delta^{-1}J(x)}. \quad (2.16)$$

In principle we have worked out the functional integral, but we need to find  $\Delta^{-1}$ .  $\Delta$  is a differential operator, hence  $\Delta^{-1}$  is a GREEN<sup>18</sup>'s function. So the next step will be to obtain the inverse of  $\Delta$ .

Note that our final result is the infinite-dimensional analogue of the result we derived before,

$$Z_{\underline{A}, \underline{b}} = Z_{\underline{A}} e^{\frac{1}{2}\underline{b} \cdot \underline{A}^{-1} \underline{b}}, \quad (2.17)$$

where  $\underline{A}^{-1}$  was the inverse of the matrix  $\underline{A}$ . In this case, we essentially have to solve the equation

$$-\Delta_x \Delta_F(x-y) = \delta^d(x-y), \quad (2.18)$$

so that  $\Delta_F(x)$  is a GREEN's function of the operator  $\Delta$ . We can solve this fairly easily by using FOURIER<sup>19</sup> transformations: We define

$$\tilde{\Delta}_F(p) = \int d^d x e^{-ip \cdot x} \Delta_F(x) = \int d^d x e^{-ip \cdot (x-y)} \Delta_F(x-y), \quad (2.19)$$

where  $p \cdot x = p_\mu x^\mu$ . Multiplying the above equation by  $e^{-ip \cdot (x-y)}$  and integrating over all  $x$  components gives

$$-\int d^d x e^{-ip \cdot (x-y)} \Delta_x \Delta_F(x-y) = \int d^d x \delta^d(x-y) e^{-ip \cdot (x-y)} = 1. \quad (2.20)$$

Since  $\Delta_x = -\square_x + m^2$ , we can integrate the left-hand side twice by parts, dropping surface terms to obtain

$$-\int d^d x \Delta_x \left( e^{-ip \cdot (x-y)} \right) \Delta_F(x-y) = -\int d^d x (p^2 + m^2) e^{-ip \cdot (x-y)} \Delta_F(x-y) = 1. \quad (2.21)$$

---

<sup>18</sup>Green, George (1793-1841)

<sup>19</sup>Fourier, Joseph (1768-1830)

So the equation that you then get is

$$-(p^2 + m^2)\tilde{\Delta}_F(p) = 1. \quad (2.22)$$

There is an ambiguity here; there is no unique solution to the above differential equation since one can always add a solution of the homogeneous equation to  $\Delta_F(x - y)$ . We need boundary conditions to make  $\Delta_F$  unique. The choice

$$\boxed{\tilde{\Delta}_F(p) = -\frac{1}{p^2 + m^2 - i\epsilon}}, \quad (2.23)$$

defines the FEYNMAN propagator, where  $\epsilon > 0$  guarantees that the denominator will not be zero, and is essentially infinitesimal.

Why is this an appropriate description? To motivate this, let us go back to the original integral

$$Z_0[J] = \int d[\phi] e^{-\frac{i}{2} \int d^d x (\partial^\mu \phi(x) \partial_\mu \phi(x) + m^2 \phi^2(x)) + i \int d^d x J(x) \phi(x)}. \quad (2.24)$$

This is an integral with a highly oscillating integrand; if we replace  $m^2 \rightarrow m^2 - i\epsilon$  for positive small  $\epsilon$  this will give a factor

$$E^{-\frac{1}{2}\epsilon \int d^d x \phi^2(x)}, \quad (2.25)$$

ensuring convergence of the functional integral. The integration is damped for large  $\phi$ .

Let us try and analyse  $\Delta_F(x)$ . We can do this by going back to the FOURIER transform

$$i\Delta_F(x) = -i \int \frac{d^d p}{(2\pi)^d} e^{ip \cdot x} \frac{1}{p^2 + m^2 - i\epsilon}. \quad (2.26)$$

Defining  $E_{\vec{p}} = \sqrt{m^2 + \vec{p}^2}$ , we can rewrite

$$p^2 + m^2 - i\epsilon = -(p^0)^2 + (E_{\vec{p}} - i\epsilon)^2. \quad (2.27)$$

Note that this means a re-definition of  $\epsilon$ , since there will now be a term of  $-2iE_{\vec{p}}\epsilon$  on the right-hand side (and we ignore  $\epsilon^2$ ). But since the exact magnitude of  $\epsilon$  does not matter and we will in both cases get a small negative imaginary quantity appearing on both sides, this is a valid replacement. We obtain the expression

$$\begin{aligned} i\Delta_F(x) &= i \int \frac{d^{d-1} p}{(2\pi)^{d-1}} \int \frac{dp^0}{2\pi} e^{-ip^0 t + i\vec{p} \cdot \vec{x}} \frac{1}{(p^0)^2 - (E_{\vec{p}} - i\epsilon)^2} \\ &= i \int \frac{d^{d-1} p}{(2\pi)^{d-1}} \int \frac{dp^0}{2\pi} e^{-ip^0 t + i\vec{p} \cdot \vec{x}} \frac{1}{2E_{\vec{p}}} \left( \frac{1}{p^0 - E_{\vec{p}} + i\epsilon} - \frac{1}{p^0 + E_{\vec{p}} - i\epsilon} \right). \end{aligned} \quad (2.28)$$

To evaluate the  $p^0$  integral, close the contour in the complex plane in the upper half or lower half plane such that  $e^{-ip^0 t} \rightarrow 0$ . Note that this means that for  $t < 0$  the contour is closed in the upper half plane, whereas for  $t > 0$  the contour is closed in the lower half plane (which gives an extra minus sign in the residue because of clockwise orientation):

$$i\Delta_F(x) = i \int \frac{d^{d-1} p}{(2\pi)^{d-1}} \frac{1}{2\pi} \frac{1}{2E_{\vec{p}}} e^{i\vec{p} \cdot \vec{x}} (-2\pi i \theta(t) e^{-iE_{\vec{p}} t} - 2\pi i \theta(-t) e^{iE_{\vec{p}} t}), \quad (2.29)$$

where  $\theta(t) = \begin{cases} 1, & t \geq 0 \\ 0, & t < 0 \end{cases}$  is a step function. Our final result is

$$i\Delta_F(x) = \int \frac{d^{d-1} p}{(2\pi)^{d-1}} \frac{1}{2E_{\vec{p}}} e^{i\vec{p} \cdot \vec{x}} (\theta(t) e^{-iE_{\vec{p}} t} + \theta(-t) e^{iE_{\vec{p}} t}). \quad (2.30)$$

The first term corresponds to positive frequency or positive energy particles going forward in time, the second term corresponds to negative frequency anti-particles (or particles going backwards in time).

We now have the final expression for the generating functional

$$Z_0[J] = e^{-\frac{1}{2} \int d^d x d^d y J(x) i\Delta_F(x-y) J(y)}. \quad (2.31)$$

We define the two-point correlation function to be given by

$$\langle \phi(x_1) \phi(x_2) \rangle = (-i)^2 \frac{\delta}{\delta J(x_1)} \frac{\delta}{\delta J(x_2)} Z_0[J] \Big|_{J=0}, \quad (2.32)$$

a relation which is true for free fields. Explicitly this gives, since  $\Delta_F(x-y) = \Delta_F(y-x)$ ,

$$\langle \phi(x_1) \phi(x_2) \rangle = \frac{\delta}{\delta J(x_1)} \int d^d x J(x) i\Delta_F(x-x_2) \Big|_{J=0} = i\Delta_F(x_1-x_2). \quad (2.33)$$

We interpret this diagrammatically as a line joining two points:

$$x \text{ ————— } y$$

Similarly we define the  $n$ -point correlation function

$$\langle \phi(x_1) \dots \phi(x_n) \rangle^{(n)} = (-i)^n \frac{\delta}{\delta J(x_1)} \dots \frac{\delta}{\delta J(x_n)} Z_0[J] \Big|_{J=0}. \quad (2.34)$$

This is zero for any odd value of  $n$ . We can again represent the different contributions by diagrams, e.g. for  $n=4$  there will be three contributions:

$$\begin{array}{ccc} x_1 \text{ — } x_2 & x_1 & x_2 \\ & | & | \\ x_3 \text{ — } x_4 & x_3 & x_4 \end{array} \quad \begin{array}{c} x_1 \\ | \\ x_4 \end{array} \quad \begin{array}{ccc} x_1 & & x_2 \\ & \diagdown & / \\ & x_3 & \\ & / & \diagdown \\ & x_4 & \end{array}$$

For free fields, we have the relation

$$\langle \phi(x_1) \dots \phi(x_n) \rangle = \langle 0|T \{ \hat{\phi}(x_1) \dots \hat{\phi}(x_n) \} |0 \rangle, \quad (2.35)$$

where  $T$  denotes time ordering and  $\hat{\phi}$  is the field operator. See the result in the “Quantum Field Theory” course

$$\langle 0|T \{ \hat{\phi}(x) \hat{\phi}(y) \} |0 \rangle = i\Delta_F(x-y), \quad (2.36)$$

which can be derived using the standard expansion  $\phi$  in terms of creation operators  $\hat{a}_p^\dagger$  and annihilation operators  $\hat{a}_{\bar{p}}$ .

Free fields, however, are not terribly interesting; we extend these ideas to interacting theory.

## 2.2 Interacting Scalar Field Theory

We include a potential  $V(\phi)$  into the action

$$S[\phi] = \int d^d x (\mathcal{L}_0 - V(\phi)), \quad (2.37)$$

where  $\mathcal{L}_0$  is the free theory LAGRANGIAN, quadratic in the fields, and we assume the potential to include terms of order  $\phi^3$  and higher.

Consider what happens when we define the functional integral

$$Z[J] = \int d[\phi] e^{iS[\phi] + i \int d^d x J(x) \phi(x)}. \quad (2.38)$$

In due course we will differentiate this with respect to  $J$  and define correlation functions. We can define this integral by a *perturbation expansion*. This can be expressed in terms of FEYNMAN

diagrams, and for each diagram there is an amplitude given by the FEYNMAN rules. FEYNMAN diagrams are a pictorial way of expressing a perturbative expansion of integrals like this.

Formally, by the same tricks as previously,

$$\begin{aligned} Z[J] &= e^{-i \int d^d x V(-i \frac{\delta}{\delta J(x)})} Z_0[J] \\ &= e^{-i \int d^d x V(-i \frac{\delta}{\delta J(x)})} e^{-\frac{i}{2} \int d^d x d^d y J(x) \Delta_F(x-y) J(y)} \\ &= e^{\frac{i}{2} \int d^d x d^d y \frac{\delta}{\delta \phi(x)} \Delta_F(x-y) \frac{\delta}{\delta \phi(y)}} \cdot e^{i \int d^d x (-V(\phi(x)) + J(x)\phi(x))} \Big|_{\phi=0}, \end{aligned} \quad (2.39)$$

where in the first line we have used that  $-i \frac{\delta}{\delta J(x)} e^{i \int J\phi} = \phi(x) e^{i \int J\phi}$ , and from the second to the third line we have used the infinite-dimensional form the lemma derived in Section 1, namely

$$G \left[ -i \frac{\delta}{\delta J} \right] F[iJ] = F \left[ \frac{\delta}{\delta \phi} \right] G[\phi] e^{i \int d^d x \phi(x) \cdot J(x)} \Big|_{\phi=0}. \quad (2.40)$$

Expand this to get the perturbation expansion; we obtain the FEYNMAN rules:

### 2.2.1 Feynman Rules for Interacting Scalar Field Theory

The FEYNMAN rules to derive correlation functions between different points in spacetime are

- A line between  $x$  and  $y$  represents a propagator  $i\Delta_F(x-y)$ .

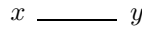

- A vertex with  $n$  lines represents a factor  $-iV^{(n)}(0)$ , where  $V^{(n)}(\phi) = \frac{d^n}{d\phi^n} V(\phi)$ .

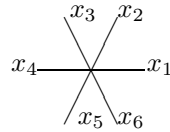

- $J(x)$  is represented by a vertex with one outgoing line.

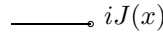

- Integrate over  $x$  for all vertices.

Introduce a symmetry factor  $S$  where necessary and divide by  $S$ .

If we consider an  $n$ -point correlation function

$$\langle \phi(x_1) \dots \phi(x_n) \rangle^{(n)}, \quad (2.41)$$

we have diagrams with  $n$  external lines, one for each  $x_i$ , and we drop  $J$ . The first contributions to  $\langle \phi(x)\phi(y) \rangle$  will be

$$x \text{ --- } y \quad + \quad x \text{ --- } z \text{ --- } \bigcirc \text{ --- } w \text{ --- } y \quad (S = 2)$$

There are slightly alternative versions of the FEYNMAN rules:

#### FEYNMAN Rules for Momentum Space

Consider

$$\int d^d x_1 \dots d^d x_n e^{i(p_1 x_1 + \dots + p_n x_n)} \langle \phi(x_1) \dots \phi(x_n) \rangle^{(n)} =: F^{(n)}(p_1, \dots, p_n), \quad (2.42)$$

which will contain an overall delta function  $\delta^d(\sum_i p_i)$  (energy-momentum conservation).

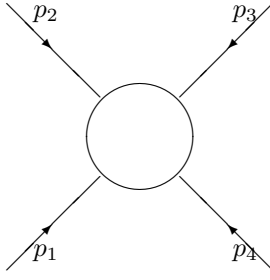

We make use of the FOURIER transform of the FEYNMAN propagator,

$$i\Delta_F(x-y) = \int \frac{d^d p}{(2\pi)^d} e^{ip \cdot (x-y)} \left( -\frac{i}{p^2 + m^2 - i\epsilon} \right), \quad (2.43)$$

and after integrating over the position for each vertex, generating a  $\delta$ -function, this leads to the following rules:

- For each internal line with associated momentum  $k$ , add a propagator

$$-\frac{i}{k^2 + m^2 - i\epsilon} \cdot \begin{array}{c} \longrightarrow k \end{array} \quad (2.44)$$

- For an external line with associated momentum  $p$ , add a propagator  $\frac{-i}{p^2 + m^2}$ .
- For each vertex with  $n$  outgoing lines, add a factor

$$-iV^{(n)}(0) (2\pi)^d \delta^d(\sum_i p_i). \quad (2.45)$$

- Integrate over momenta for all internal lines with measure

$$\frac{d^d k_i}{(2\pi)^d}. \quad (2.46)$$

The  $(2\pi)^{-d}$  factor could have been associated with the propagator.

Thus for the loop diagram

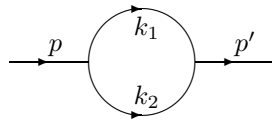

the vertices will give factors  $\delta^d(p - k_1 - k_2)$  and  $\delta^d(k_1 + k_2 - p')$ , so after integration there will be an overall delta function  $\delta^d(p - p')$ .

Recall (1.133), Euler's formula for connected diagrams:

$$L = I - V + 1,$$

where  $L$  is the number of loops,  $I$  is the number of internal lines and  $V$  is the number of vertices. Let us look at the integrations performed for a particular diagram in momentum space. We have the integral

$$\int \prod_{i=1}^I \frac{d^d k_i}{(2\pi)^d} \prod_{v=1}^V (2\pi)^d \delta^d(\sum_i p_{i,v}), \quad (2.47)$$

since there are  $I$  momenta associated to internal lines and  $V$  vertices where energy-momentum conservation is imposed for all momenta  $\{p_{i,v}\}$  for all lines incident at each vertex  $v$ . For

connected graphs there is one overall delta function for overall momentum conservation. After removing all but one the momentum conservation  $\delta$ -functions there are  $I - V + 1$  remaining momenta to be integrated over, which is equal to  $L$ , the number of loops. Hence this becomes

$$(2\pi)^d \delta^d(\sum_i p_i) \prod_{j=1}^L \frac{d^d k_j}{(2\pi)^d}, \quad (2.48)$$

where the sum  $\sum_i$  runs over external lines and  $\prod_j$  is such that  $\{k_j\}$  are  $L$  independent, after imposing momentum conservation at each vertex, internal line momentum. The overall  $(2\pi)^d \delta^d(\sum_i p_i)$  is usually factored out.

Furthermore, if we look at the various factors of  $i$  in the FEYNMAN integral, we notice that there is a factor of  $-i$  for each internal line and a factor of  $-i$  for each vertex giving in total

$$(-i)^I (-i)^V = (-1)^V i^{1-L}. \quad (2.49)$$

We can use this to simplify the FEYNMAN rules in momentum space:

- For each internal line with associated momentum  $k$ , add a propagator

$$\frac{1}{k^2 + m^2 - i\epsilon}. \quad (2.50)$$

- For an external line with associated momentum  $p$ , add a propagator  $\frac{-i}{p^2 + m^2}$ .
- For each vertex with  $n$  outgoing lines, add a factor  $-V^{(n)}(0)$ .
- Impose momentum conservation at each vertex.
- Add a factor  $-i$  for each loop and integrate over undetermined loop momenta  $\int \frac{d^d k}{(2\pi)^d}$ .
- There is an overall factor of  $i(2\pi)^d$  times a delta function imposing overall energy-momentum conservation.

These rules may seem complicated, but to work them out in practice is quite straightforward. Here are some illustrations.

For the simplest case  $n = 2$ , the diagram

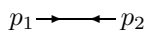

corresponds to the amplitude

$$\frac{1}{p_1^2 + m^2} (2\pi)^d \delta^d(p_1 + p_2). \quad (2.51)$$

For a potential with  $V^{(4)}(0) = \lambda$ , the diagram

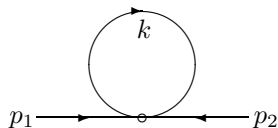

corresponds to

$$\frac{1}{2} \frac{(-i)^2}{(p_1^2 + m^2)(p_2^2 + m^2)} i(2\pi)^d \delta^d(p_1 + p_2) (-\lambda)(-i) \int \frac{d^d k}{(2\pi)^d} \frac{1}{k^2 + m^2 - i\epsilon}, \quad (2.52)$$

where we have added a symmetry factor of 2.

For a potential  $V$  with  $V^{(3)}(0) = g$ , the diagram

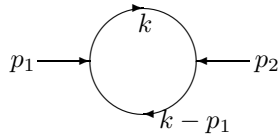

is associated to the amplitude

$$\frac{1}{2} \frac{(-i)^2}{(p_1^2 + m^2)(p_2^2 + m^2)} i(2\pi)^d \delta^d(p_1 + p_2) (-g)^2 (-i) \int \frac{d^d k}{(2\pi)^d} \frac{1}{(k^2 + m^2 - i\epsilon)((k - p_1)^2 + m^2 - i\epsilon)}. \quad (2.53)$$

The guts of these calculations are in terms of doing the integrals. These are both *one-loop diagrams*. When a diagram has no loops, there are no momentum integrations left.

In general, calculations with one or two loops are quite straightforward, but become rapidly difficult for more loops.

### 2.2.2 Connected and Disconnected Graphs

A *connected* graph is one in which all lines are linked. Consider

$$\langle \phi(x_1)\phi(x_2)\phi(x_3)\phi(x_4) \rangle^{(4)}. \quad (2.54)$$

In free theory, there are the following sets of graphs:

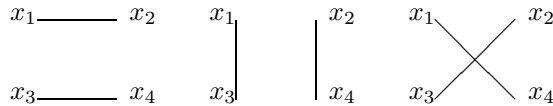

These are all *disconnected graphs*. In interacting theory, we have the following *connected graphs*:

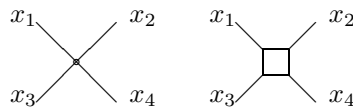

Of course, there can still be disconnected graphs:

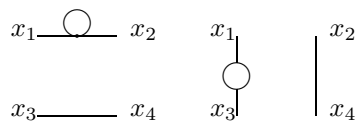

It is sort of obvious that any disconnected graph is composed of connected subgraphs. For instance, in the above examples all disconnected graphs consist of two connected subgraphs. In calculations, one can calculate disconnected graphs by calculating the connected subgraphs and multiplying them together.

Let us now assume for simplicity that  $\langle \phi(x) \rangle = 0$ , and write

$$\langle \phi(x_1)\phi(x_2) \rangle^{(2)} = \langle \phi(x_1)\phi(x_2) \rangle_{\text{conn.}}^{(2)}. \quad (2.55)$$

By assumption, there are no graphs with one external line; we represent the sum of connected graphs by

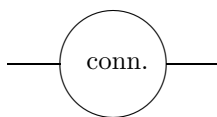



Now use this to decompose  $\langle \phi(x_1)\phi(x_2)\phi(x_3)\phi(x_4) \rangle^{(4)}$  into connected pieces. This will give

$$\begin{aligned} \langle \phi(x_1)\phi(x_2)\phi(x_3)\phi(x_4) \rangle^{(4)} &= \langle \phi(x_1)\phi(x_2) \rangle^{(2)} \langle \phi(x_3)\phi(x_4) \rangle^{(2)} + 2 \text{ similar terms} \\ &+ \langle \phi(x_1)\phi(x_2)\phi(x_3)\phi(x_4) \rangle_{\text{conn.}}^{(4)}. \end{aligned} \quad (2.56)$$

We can represent this pictorially by

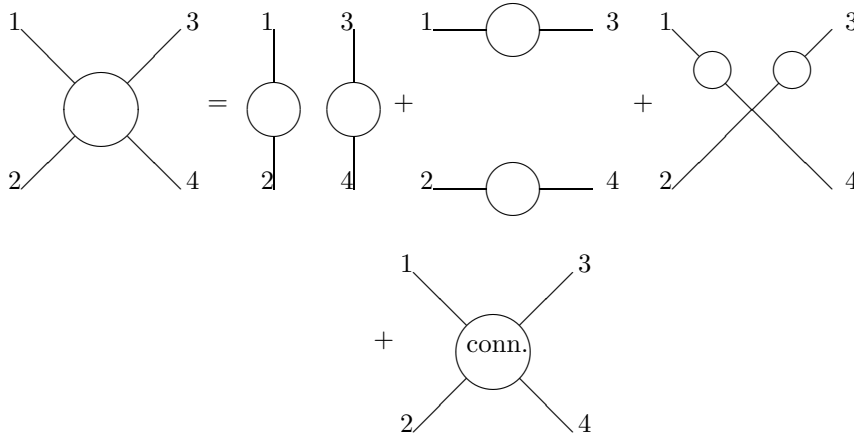

Now we want to discuss the *generating functional* which does this, i.e. which only gives connected amplitudes. We previously defined  $Z[J]$  such that

$$(-i)^n \frac{\delta}{\delta J(x_1)} \cdots \frac{\delta}{\delta J(x_n)} Z[J] \Big|_{J=0} = \langle \phi(x_1) \dots \phi(x_n) \rangle^{(n)}. \quad (2.57)$$

If we now write  $Z[J] = e^{iW[J]}$ , then  $W[J]$  is the generating functional for connected amplitudes. We make the assertion that

$$\boxed{(-i)^{n-1} \frac{\delta}{\delta J(x_1)} \cdots \frac{\delta}{\delta J(x_n)} W[J] \Big|_{J=0} = \langle \phi(x_1) \dots \phi(x_n) \rangle_{\text{conn.}}^{(n)}.} \quad (2.58)$$

The way to justify this is to show that if we substitute this formula into the first expression, this gives the correct expansion of an  $n$ -point correlation function  $\langle \dots \rangle$  in terms of connected  $m$ -point correlation functions  $\langle \dots \rangle_{\text{conn.}}$  which represent only connected diagrams. (All graphs with  $n$  points can be expressed in terms of connected graphs with  $m \leq n$  points.) Mathematically, we express this relation as

$$\langle \phi(x_1) \dots \phi(x_n) \rangle^{(n)} = \sum_{r=0}^{n-1} \sum_{\{i_1, \dots, i_r\} \subset \{2, \dots, n\}} \langle \phi(x_1)\phi(x_{i_1}) \dots \phi(x_{i_r}) \rangle_{\text{conn.}}^{(r+1)} \times \langle \phi(x_{i_{r+1}}) \dots \phi(x_{i_{n-1}}) \rangle^{(n-r-1)}, \quad (2.59)$$

where the second sum runs over all subsets of  $\{i_1, \dots, i_r\} \in \{2, \dots, n\}$  which contain  $r$  elements, and we define  $\{i_{r+1}, \dots, i_{n-1}\} = \{2, \dots, n\} \setminus \{i_1, \dots, i_r\}$ . This means that we pick one preferred line corresponding to  $x_1$ , and sum over all connected graphs including  $x_1$  with between one and  $n$  external lines, multiplied by all possible graphs for the remaining external lines. This gives a recursive definition for the left-hand side.

In calculations like these, it is sometimes hard to see the wood for the trees; we will clarify the mathematical expression by drawing appropriate pictures.

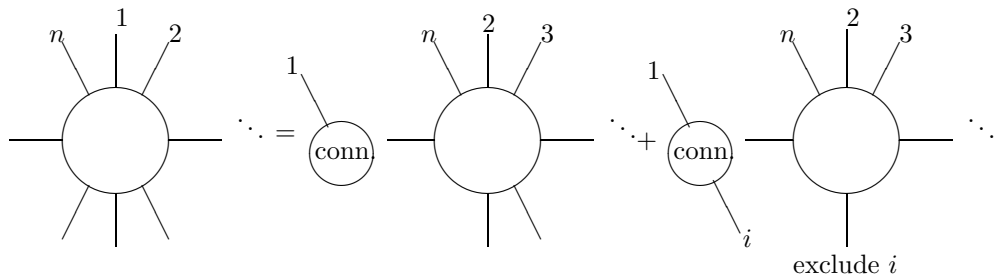

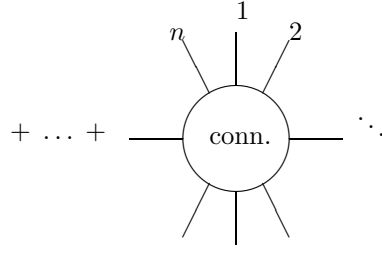

We will now show that assuming that  $W[J]$  generates all connected graphs, the relation  $Z[J] = e^{iW[J]}$  holds. We use the above relation, substituting in our expressions for the  $(r + 1)$ -point correlation function and the connected  $(n - r - 1)$ -point correlation function in terms of  $Z[J]$  and  $W[J]$ :

$$\begin{aligned}
& \frac{\delta}{\delta J(x_1)} \cdots \frac{\delta}{\delta J(x_n)} Z[J] \Big|_{J=0} \\
&= i \sum_{r=0}^{n-1} \sum_{\{i_1, \dots, i_r\} \subset \{2, \dots, n\}} \frac{\delta}{\delta J(x_1)} \frac{\delta}{\delta J(x_{i_1})} \cdots \frac{\delta}{\delta J(x_{i_r})} W[J] \Big|_{J=0} \cdot \frac{\delta}{\delta J(x_{i_{r+1}})} \cdots \frac{\delta}{\delta J(x_{i_{n-1}})} Z[J] \Big|_{J=0} \\
&= \frac{i}{(n-1)!} \sum_{\substack{\text{permutations} \\ (2, \dots, n)}} \sum_{r=0}^{n-1} \binom{n-1}{r} \\
&\quad \times \frac{\delta}{\delta J(x_1)} \frac{\delta}{\delta J(x_{i_1})} \cdots \frac{\delta}{\delta J(x_{i_r})} W[J] \Big|_{J=0} \cdot \frac{\delta}{\delta J(x_{i_{r+1}})} \cdots \frac{\delta}{\delta J(x_{i_{n-1}})} Z[J] \Big|_{J=0} \\
&= i \frac{\delta}{\delta J(x_2)} \cdots \frac{\delta}{\delta J(x_n)} \left( \left( \frac{\delta}{\delta J(x_1)} W[J] \right) Z[J] \right) \Big|_{J=0}, \tag{2.60}
\end{aligned}$$

where in the last line we have used the generalised LEIBNIZ<sup>20</sup> rule,

$$\frac{d^{n-1}}{dx^{n-1}} (f(x) \cdot g(x)) = \sum_{r=0}^{n-1} \binom{n-1}{r} \frac{d^r}{dx^r} f(x) \cdot \frac{d^{n-r-1}}{dx^{n-r-1}} g(x), \tag{2.61}$$

extended to functional derivatives. After applying this the result is symmetric in  $x_2, \dots, x_n$  and the sum over permutations then just cancels the  $(n - 1)!$  factor. Since the relation is true for arbitrary  $n$  it shows that all terms in a TAYLOR<sup>21</sup> expansion of both sides of

$$\frac{\delta}{\delta J(x)} Z[J] = i \left( \frac{\delta}{\delta J(x)} W[J] \right) Z[J]. \tag{2.62}$$

around  $J = 0$  are the same and hence this holds for any  $J$ . Finally this is solved by

$$\boxed{Z[J] = e^{iW[J]}.} \tag{2.63}$$

This is the relationship between the generating functional for all  $n$ -point functions and the corresponding functional for connected  $n$ -point functions.

The overall normalisation of  $Z[J]$  is generally chosen such that  $Z[0] = 1$  (which basically means that  $\langle 1 \rangle = 1$ ) and then  $W[0] = 0$ .

In momentum space, all connected amplitudes have an overall momentum conservation delta function. You can always write

$$\int d^d x_1 \dots d^d x_n e^{i \sum_i p_i x_i} \langle \phi(x_1) \dots \phi(x_n) \rangle_{\text{conn.}}^{(n)} = i(2\pi)^d \delta^d(\sum_i p_i) \tau(p_1, \dots, p_n), \tag{2.64}$$

where the function  $\tau(p_1, \dots, p_n)$  is defined only for  $\sum_i p_i = 0$ , and so basically is a function of  $n - 1$  momenta. In the case  $n = 2$ , we have  $\tau(p, -p)$ .

<sup>20</sup>Leibniz, Gottfried Wilhelm von (1646-1716)

<sup>21</sup>Taylor, Brook (1685-1731)

### 2.2.3 One Particle Irreducible Graphs

A connected graph is *one particle reducible* if it can be made disconnected by cutting one (internal) line; otherwise it is *one particle irreducible*. For example, the graphs

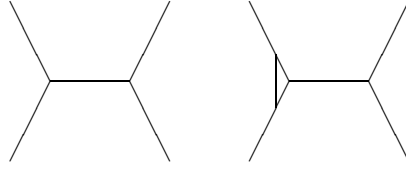

are one particle reducible, whereas the graph

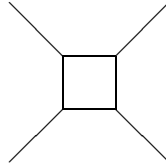

is one particle irreducible.

As we have seen it is convenient to consider connected graphs only. We notice that since all one particle reducible graphs can be formed from one particle irreducible graphs, we can also consider one particle irreducible graphs only.

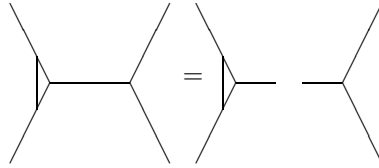

Now construct a generating functional for one particle irreducible (short: “1PI”) graphs; we will call it  $\Gamma$ . We seek to find a relation between  $W$  and  $\Gamma$  to have relations

$$Z[J] \leftrightarrow W[J] \leftrightarrow \Gamma[\varphi]. \quad (2.65)$$

The relationship between  $W$  and  $\Gamma$  is a little more complicated than the one between  $Z$  and  $W$ . Assume we have  $W[J]$ , which is defined for any  $J(x)$ ; then a TAYLOR expansion will give  $\langle \phi(x_1) \dots \phi(x_n) \rangle_{\text{conn.}}$ . We define

$$\langle \phi(x) \rangle_J = \frac{\delta W[J]}{\delta J(x)} =: \varphi(x). \quad (2.66)$$

We assume that there is an invertible relation between  $\varphi$  and  $J$ , so that we can express  $\varphi = \varphi(J)$  and  $J = J(\varphi)$  (this is non local so that  $\varphi(x)$  does not just depend on  $J(x)$ ). Let us also assume that if  $J = 0$ , then  $\varphi = 0$ . Then define  $\Gamma[\varphi]$  by

$$W[J] + \Gamma[\varphi] = \int d^d x' \varphi(x') J(x'). \quad (2.67)$$

To see what this means, let us differentiate with respect to  $\varphi(x)$ :

$$\frac{\delta}{\delta \varphi(x)} W[J] + \frac{\delta}{\delta \varphi(x)} \Gamma[\varphi] = J(x) + \int d^d x' \varphi(x') \frac{\delta J(x')}{\delta \varphi(x)}. \quad (2.68)$$

The first term on the left is, by the standard chain rule,

$$\frac{\delta}{\delta\varphi(x)}W[J] = \int d^d x' \frac{\delta W[J]}{\delta J(x')} \frac{\delta J(x')}{\delta\varphi(x)} = \int d^d x' \varphi(x') \frac{\delta J(x')}{\delta\varphi(x)}. \quad (2.69)$$

So it cancels with the second term on the right and we are left with

$$\frac{\delta}{\delta\varphi(x)}\Gamma[\varphi] = J(x). \quad (2.70)$$

The relationship between  $W$  and  $\Gamma$  is sometimes called a LEGENDRE<sup>22</sup> transformation. (You encounter this in thermodynamics, for example; consider the relationship  $F \leftrightarrow E$  between free energy and energy. Given the energy  $E(S)$  as a function of entropy, we can define the temperature  $T$  by  $T = \frac{\partial E}{\partial S}$  and make a LEGENDRE transformation

$$f(T) = E - TS, \quad (2.71)$$

so that  $\frac{\partial F}{\partial T} = -S$ .)

$\Gamma[\varphi]$  is the generating functional of one particle irreducible graphs.

We need to find a formula for  $\frac{\delta}{\delta J(x)}$  in terms of  $\frac{\delta}{\delta\varphi(y)}$ . We use the chain rule to obtain

$$\frac{\delta}{\delta J(x)} = \int d^d y \frac{\delta\varphi(y)}{\delta J(x)} \frac{\delta}{\delta\varphi(y)} = \int d^d y \frac{\delta^2 W[J]}{\delta J(x)\delta J(y)} \frac{\delta}{\delta\varphi(y)} = i \int d^d y G_2(x, y) \frac{\delta}{\delta\varphi(y)}, \quad (2.72)$$

with the definition

$$G_n(x_1, \dots, x_n) = (-i)^{n-1} \frac{\delta}{\delta J(x_1)} \dots \frac{\delta}{\delta J(x_n)} W[J], \quad (2.73)$$

so that  $G_n(x_1, \dots, x_n)|_{J=0} = \langle \phi(x_1) \dots \phi(x_n) \rangle_{\text{conn.}}^{(n)}$ . We also introduce the notation

$$\Gamma_n(x_1, \dots, x_n) = -i \frac{\delta}{\delta\varphi(x_1)} \dots \frac{\delta}{\delta\varphi(x_n)} \Gamma[\varphi]. \quad (2.74)$$

Now we claim that  $\Gamma[\varphi]$  generates one particle irreducible graphs, i.e.

$$\Gamma_n(x_1, \dots, x_n) \Big|_{\varphi=0} = \langle \phi(x_1) \dots \phi(x_n) \rangle_{\text{conn.}, 1PI}. \quad (2.75)$$

By using our previously derived formula, we note that

$$\begin{aligned} \delta^d(x-z) &= \frac{\delta J(z)}{\delta J(x)} = i \int d^d y G_2(x, y) \frac{\delta}{\delta\varphi(y)} J(z) \\ &= i \int d^d y G_2(x, y) \frac{\delta^2}{\delta\varphi(y)\delta\varphi(z)} \Gamma[\varphi] = - \int d^d y G_2(x, y) \Gamma_2(y, z). \end{aligned} \quad (2.76)$$

Now,  $G_2(x, y)$  and  $\Gamma_2(z, y)$  are essentially like matrices with continuous indices  $x, y, z$ ; then  $\delta^d(x-z)$  is essentially the unit matrix. This shows that

$$G_2 = -\Gamma_2^{-1}. \quad (2.77)$$

For further calculations, introduce pictorial representations. Represent  $G_n$  and  $\Gamma_n$  by

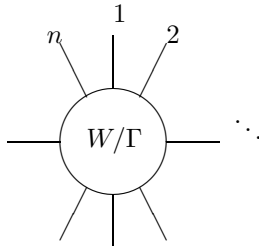

<sup>22</sup>Legendre, Adrien-Marie (1752-1833)

where we write  $W$  for  $G_n$  and  $\Gamma$  for  $\Gamma_n$ , respectively. We have shown that

$$\text{---} \bigcirc \text{---} \begin{matrix} W \\ \text{---} \end{matrix} = - \left( \text{---} \bigcirc \text{---} \begin{matrix} \Gamma \\ \text{---} \end{matrix} \right)^{-1}$$

Note also that from the above formula,

$$-i \frac{\delta}{\delta J(x)} = \frac{x}{\text{---}} \bigcirc \text{---} \frac{y}{\text{---}} \frac{\delta}{\delta \varphi(y)}$$

Note that  $-i \frac{\delta}{\delta J(x)}$  adds an external line to  $G_n$ , while  $\frac{\delta}{\delta \varphi(y)}$  adds an external line to  $\Gamma_n$ . Therefore

$$\begin{aligned} -i \frac{\delta}{\delta J(x)} \text{---} \bigcirc \text{---} &= \text{---} \bigcirc \text{---} \\ &= \text{---} \bigcirc \text{---} \frac{\delta}{\delta \varphi(y)} \left( \text{---} \bigcirc \text{---} \right)^{-1} \\ &= \text{---} \bigcirc \text{---} \begin{matrix} \bigcirc \\ | \\ W \\ | \\ \bigcirc \\ | \\ \Gamma \\ | \\ \bigcirc \\ | \\ W \\ | \\ \bigcirc \end{matrix} \text{---} \end{aligned}$$

where we have generalised the standard result for matrices

$$\frac{d}{d\lambda} \underline{M}^{-1} = -\underline{M}^{-1} \frac{d}{d\lambda} \underline{M} \underline{M}^{-1}, \quad (2.78)$$

to infinite dimensions, so that

$$\begin{aligned} \frac{\delta}{\delta \varphi(w)} (-\Gamma_2(y, z))^{-1} &= \int d^d u d^d v \Gamma_2(y, u)^{-1} \frac{\delta \Gamma_2(u, v)}{\delta \varphi(w)} \Gamma_2(v, z)^{-1} \\ &= \int d^d u d^d v \Gamma_2(y, u)^{-1} \Gamma_3(w, u, v) \Gamma_2(v, z)^{-1} \\ &= \int d^d u d^d v G_2(y, u) \Gamma_3(w, u, v) G_2(v, z). \end{aligned} \quad (2.79)$$

This gives

$$G_3(x, y, z) = -i \frac{\delta}{\delta J(x)} G_2(y, z) = \int d^d u d^d v d^d w G_2(x, w) G_2(y, u) \Gamma_3(w, u, v) G_2(v, z), \quad (2.80)$$

expressing  $G_3$  in terms of  $\Gamma_3$ . This can be extended to higher values of  $n$ , for instance in diagrammatic terms for  $n = 4$ ,

$$-i \frac{\delta}{\delta J(x)} \text{---} \bigcirc \text{---} = \text{---} \bigcirc \text{---} = \text{---} \bigcirc \text{---} \begin{matrix} \bigcirc \\ | \\ W \\ | \\ \bigcirc \\ | \\ \Gamma \\ | \\ \bigcirc \\ | \\ W \\ | \\ \bigcirc \end{matrix} \text{---}$$

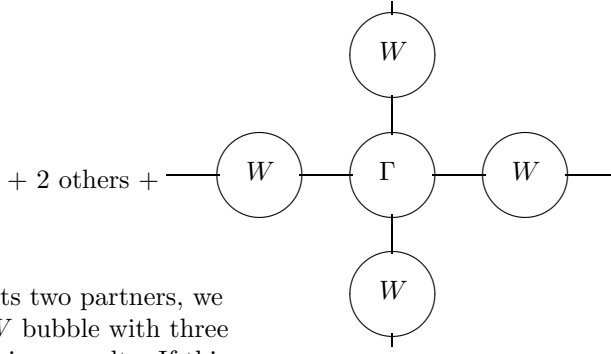

In the first graph, and its two partners, we can substitute for the  $W$  bubble with three external lines using previous results. If this is done all graphs on the right-hand side are then one particle reducible graphs.

### 2.2.4 Tree Approximation

If Feynman graphs with loops are neglected there is a very simple expression for the generating functionals  $W$  and  $\Gamma$  in terms of the original action  $S$ . We start from the functional integral result

$$Z[J] = \int d[\phi] e^{\frac{i}{\hbar}(S[\phi] + \int d^d x J(x)\phi(x))}, \quad (2.81)$$

where Planck's constant is reintroduced. This ensures the exponent is dimensionless if  $S$  has the dimensions of action ( $ML^2T^{-1}$ ). In the classical limit when loops are discarded  $\hbar \rightarrow 0$ . The functional integral is then dominated by contributions where the exponent is stationary or

$$\left. \frac{\delta}{\delta\phi(x)} S[\phi] \right|_{\phi=\phi_J} = -J(x), \quad (2.82)$$

and then

$$Z[J] \sim e^{\frac{i}{\hbar}(S[\phi_J] + \int d^d x J(x)\phi_J(x))}. \quad (2.83)$$

Hence setting  $\hbar = 1$  again in this limit for zero loops

$$W[J]^{(0)} = S[\phi_J] + \int d^d x J(x)\phi_J(x). \quad (2.84)$$

It is easy to see that

$$\frac{\delta}{\delta J(x)} W[J]^{(0)} = \phi_J, \quad (2.85)$$

and therefore

$$\Gamma[\varphi]^{(0)} = -S[\varphi]. \quad (2.86)$$

## 2.3 FERMIONIC FIELDS

We proceed to FERMIONIC<sup>23</sup> fields and will develop a formalism to define a quantum field theory for FERMIONS in terms of path integrals. The critical difference to BOSONIC<sup>24</sup> fields is that FERMIONIC fields anti-commute, which is necessary for consistency with relativity and locality. We know how to define functional integrals for BOSONIC fields, and we want to construct a framework where we can look at functional integrals in a similar fashion.

To do this we first discuss functions of a finite set of *anti-commuting* or GRASSMANN<sup>25</sup> variables  $\{\theta_i\}$ ,  $i = 1, \dots, n$ , which satisfy

$$\boxed{\theta_i\theta_j + \theta_j\theta_i = 0}, \quad (2.87)$$

<sup>23</sup>Fermi, Enrico (1901-1954), Nobel Prize 1938

<sup>24</sup>Bose, Satyendra Nath (1894-1974)

<sup>25</sup>Grassmann, Hermann Günther (1809-1877)

for all  $i$  and  $j$ . It follows that for all  $i$

$$\theta_i^2 = 0. \quad (2.88)$$

Apart from anti-commuting GRASSMANN numbers form a vector space, they can be added and multiplied by conventional numbers  $a$  so that  $a\theta = \theta a$  and since multiplication  $\theta_i\theta_j$  is allowed mathematically they form a ring.

It follows from  $\theta_i^2 = 0$  that any function  $f(\theta)$  is a finite linear sum

$$f(\underline{\theta}) = a + a_i\theta_i + \frac{1}{2}a_{ij}\theta_i\theta_j + \dots + \frac{1}{n!}a_{i_1\dots i_n}\theta_{i_1}\theta_{i_2}\dots\theta_{i_n}, \quad (2.89)$$

where we can take the coefficients to be totally antisymmetric, i.e.  $a_{ij} = -a_{ji}$ ,  $a_{ijk} = -a_{jik} = a_{jki}$  etc.

We can also define a differentiation operator  $\frac{\partial}{\partial\theta_i}$  that also anti-commutes

$$\frac{\partial}{\partial\theta_i}\theta_j + \theta_j\frac{\partial}{\partial\theta_i} = \delta_{ij}. \quad (2.90)$$

We further need to extend the notion of integration to GRASSMANN numbers, requiring that for any function  $f(\theta)$  it is linear, translation invariant and gives an ordinary number depending on  $f$ . (We only consider analogues to integrals over all  $x \int_{-\infty}^{\infty} dx f(x)$ .) By translation invariance we must have

$$\int d\theta \theta = \int d\theta (\theta + \theta_0), \quad (2.91)$$

which means that

$$\int d\theta = 0. \quad (2.92)$$

We can choose a normalisation such that

$$\int d\theta \theta = 1. \quad (2.93)$$

In consequence, we have for any function

$$\int d\theta (a + b\theta) = b = \frac{\partial}{\partial\theta}(a + b\theta), \quad (2.94)$$

so differentiation and integration is much the same, at least in this case. For  $n$  variables  $\theta_i$  we define an integration measure

$$d^n\theta = d\theta_n d\theta_{n-1} \dots d\theta_1. \quad (2.95)$$

Note that since

$$d\theta_i d\theta_j = -d\theta_j d\theta_i, \quad (2.96)$$

which is necessary for consistency, the order of the differentials is important. So for a general function  $f(\underline{\theta})$ ,

$$\int d^n\theta f(\underline{\theta}) = a_{12\dots n} = \frac{1}{n!}\epsilon_{i_1 i_2 \dots i_n} a_{i_1 i_2 \dots i_n}, \quad (2.97)$$

where  $\epsilon_{i_1 \dots i_n}$  is the  $n$ -dimensional antisymmetric symbol with  $\epsilon_{12\dots n} = 1$ .<sup>26</sup> Equivalently, we can note that

$$\boxed{\int d^n\theta \theta_{i_1} \dots \theta_{i_n} = \epsilon_{i_1 i_2 \dots i_n}.} \quad (2.98)$$

It is easy to see that with these definitions

$$\int d^n\theta \frac{\partial}{\partial\theta_i} f(\underline{\theta}) = 0, \quad (2.99)$$

and hence we can integrate by parts, taking into account the anti-commuting properties of the derivative.

<sup>26</sup>This is the higher-dimensional analogue of the famous “ $\epsilon_{ijk}$ ”, of course.

For a change of variables  $\theta'_i = A_{ij}\theta_j$ , where  $\underline{A}$  is an  $(n \times n)$  matrix:

$$\begin{aligned} \int d^n\theta f(\underline{A}\underline{\theta}) &= \int d^n\theta a_{12\dots n} A_{1i_1} \dots A_{ni_n} \theta_{i_1} \dots \theta_{i_n} \\ &= a_{12\dots n} A_{1i_1} \dots A_{ni_n} \epsilon_{i_1 i_2 \dots i_n} = (\det \underline{A}) \cdot a_{1\dots n} = \det \underline{A} \int d^n\theta f(\underline{\theta}). \end{aligned} \quad (2.100)$$

Let us consider this in terms of  $\underline{\theta}' = \underline{A}\underline{\theta}$ :

$$\int d^n\theta f(\underline{\theta}') = \det \underline{A} \int d^n\theta' f(\underline{\theta}'), \quad (2.101)$$

so we obtain the transformation law

$$\boxed{d^n\theta' = d^n(A\theta) = (\det \underline{A})^{-1} d^n\theta.} \quad (2.102)$$

Note that for BOSONIC variables,

$$d^n(Ax) = \det \underline{A} \cdot d^n x. \quad (2.103)$$

$\det A$  is the JACOBIAN<sup>27</sup> which appears in this context.

### 2.3.1 GAUSSIAN INTEGRALS for GRASSMANN Variables

Consider integrals of the following form

$$\int d^n\theta e^{\frac{1}{2}A_{ij}\theta_i\theta_j}, \quad (2.104)$$

where  $\underline{A}$  is an antisymmetric  $(n \times n)$  matrix, i.e.  $A_{ij} = -A_{ji}$ , where the dimension  $n$  is taken to be even and we write  $n = 2m$ .

To evaluate this we expand the exponential; only the term containing  $n$  powers of  $\theta$  give a non zero contribution to the integral, i.e. we only need to consider the  $m$ th term in the expansion:

$$\begin{aligned} \int d^n\theta e^{\frac{1}{2}A_{ij}\theta_i\theta_j} &= \int d^n\theta \frac{1}{2^m m!} A_{i_1 i_2} \dots A_{i_{n-1} i_n} \theta_{i_1} \dots \theta_{i_n} \\ &= \frac{1}{2^m m!} A_{i_1 i_2} \dots A_{i_{n-1} i_n} \epsilon_{i_1 \dots i_n} \equiv \text{Pf}(\underline{A}), \end{aligned} \quad (2.105)$$

where  $\text{Pf}(\underline{A})$  is the PFAFFIAN<sup>28</sup>.

There is a relation between  $\text{Pf}(\underline{A})$  and  $\det \underline{A}$ : Consider a change of variables  $\underline{\theta} \rightarrow \underline{B}\underline{\theta} = \underline{\theta}'$  and use the rules for a change of variables to obtain

$$\text{Pf}(\underline{A}) = \int d^n\theta' e^{\frac{1}{2}A_{ij}\theta'_i\theta'_j} = (\det \underline{B})^{-1} \int d^n\theta e^{\frac{1}{2}A_{ij}B_{ik}\theta_k B_{jl}\theta_l} = (\det \underline{B})^{-1} \text{Pf}(\underline{B}^T \underline{A} \underline{B}), \quad (2.106)$$

(note that  $A_{ij}B_{ik}B_{jl} = (\underline{B}^T \underline{A} \underline{B})_{kl}$ .) This implies

$$\text{Pf}(\underline{B}^T \underline{A} \underline{B}) = \det \underline{B} \cdot \text{Pf}(\underline{A}). \quad (2.107)$$

A standard result for matrices is that we can find a matrix  $\underline{B}$  to put  $\underline{A}$  in a standard form, namely that (note that  $\underline{B}^T \underline{A} \underline{B}$  is antisymmetric for any matrix  $\underline{B}$ ):

$$\underline{B}^T \underline{A} \underline{B} = \begin{pmatrix} 0 & 1 & & & & \\ -1 & 0 & & & & \\ & & 0 & 1 & & \\ & & -1 & 0 & & \\ & & & & \ddots & \\ & & & & & 0 & 1 \\ & & & & & -1 & 0 \end{pmatrix} =: \underline{J}. \quad (2.108)$$

<sup>27</sup>Jacobi, Carl Gustav Jakob (1804-1851)

<sup>28</sup>Pfaff, Johann Friedrich (1765-1825)



Taking the determinant on both sides we get

$$(\det \underline{B})^2 \cdot \det \underline{A} = 1. \quad (2.109)$$

Furthermore,

$$\text{Pf}(\underline{J}) = \frac{1}{2^m m!} J_{i_1 i_2} \cdots J_{i_{n-1} i_n} \epsilon_{i_1 \dots i_n} = \frac{1}{2^m m!} m! 2^m = 1, \quad (2.110)$$

therefore  $\det \underline{B} \cdot \text{Pf}(\underline{A}) = 1$ . Eliminating  $\det \underline{B}$  from these relations we get

$$\text{Pf}(\underline{A})^2 = \det \underline{A}, \quad \text{Pf}(\underline{A}) = \pm \sqrt{\det \underline{A}}. \quad (2.111)$$

We may also extend this to the complex case: introducing Grassmann variables  $\theta_i$  and  $\bar{\theta}_i$ ,  $i = 1, \dots, n$ , where  $\bar{\theta}_i$  is the conjugate of  $\theta_i$ . We treat  $\theta_i$  and  $\bar{\theta}_i$  as independent and assume the rule

$$\overline{(\theta_{i_1} \dots \theta_{i_n})} = \bar{\theta}_{i_n} \dots \bar{\theta}_{i_1}. \quad (2.112)$$

Furthermore all  $\theta_i$  anticommute with all  $\bar{\theta}_j$ . Let  $\underline{B}$  be a  $(n \times n)$  matrix and consider

$$\int d^n \theta d^n \bar{\theta} e^{\bar{\theta}_i B_{ij} \theta_j}, \quad (2.113)$$

where the integration measure is defined via

$$d^n \theta d^n \bar{\theta} = \prod_{i=1}^n d\theta_i d\bar{\theta}_i = d\theta_1 d\bar{\theta}_1 \dots d\theta_n d\bar{\theta}_n = d\theta_n d\bar{\theta}_n \dots d\theta_1 d\bar{\theta}_1, \quad (2.114)$$

for we can move pairs of GRASSMANN variables around without picking up minus signs. What is nontrivial, slightly, is that  $\bar{\theta}$  is placed to the right of  $\theta$  here.

We expand the exponential and keep the  $n$ th term:

$$\int d^n \theta d^n \bar{\theta} e^{\bar{\theta}_i B_{ij} \theta_j} = \int d^n \theta d^n \bar{\theta} \frac{1}{n!} (\bar{\theta}_i B_{ij} \theta_j)^n = \frac{1}{n!} \epsilon_{i_1 \dots i_n} \epsilon_{j_1 \dots j_n} B_{i_1 j_1} \dots B_{i_n j_n} = \det \underline{B}. \quad (2.115)$$

In general integration for GRASSMANN variables is more an exercise in algebra rather than analysis and in some respects rather formal. However it plays a crucial part in the discussion of quantum field theories with fermion fields which include so-called ghost fields in gauge theories.

### 2.3.2 The Fermionic Oscillator

The harmonic oscillator for FERMIONIC fields can be described by introducing creation and annihilation operators  $\hat{\mathbf{b}}^\dagger, \hat{\mathbf{b}}$  which satisfy

$$\hat{\mathbf{b}}^2 = (\hat{\mathbf{b}}^\dagger)^2 = 0, \quad \{\hat{\mathbf{b}}, \hat{\mathbf{b}}^\dagger\} = \hat{\mathbf{1}}. \quad (2.116)$$

The states are built on a ground state  $|0\rangle$  which satisfies

$$\hat{\mathbf{b}}|0\rangle = 0. \quad (2.117)$$

We can define

$$|1\rangle = \hat{\mathbf{b}}^\dagger|0\rangle, \quad (2.118)$$

so that  $\hat{\mathbf{b}}^\dagger|1\rangle = 0$ ,  $\hat{\mathbf{b}}|1\rangle = |0\rangle$ . We have a two-dimensional space of states which can be expressed in matrix form:

$$|0\rangle = \begin{pmatrix} 1 \\ 0 \end{pmatrix}, \quad |1\rangle = \begin{pmatrix} 0 \\ 1 \end{pmatrix}; \quad \hat{\mathbf{b}}^\dagger = \begin{pmatrix} 0 & 0 \\ 1 & 0 \end{pmatrix} \quad \hat{\mathbf{b}} = \begin{pmatrix} 0 & 1 \\ 0 & 0 \end{pmatrix}. \quad (2.119)$$

We define a HAMILTONIAN

$$\hat{\mathbf{H}} = \omega \hat{\mathbf{b}}^\dagger \hat{\mathbf{b}} = \begin{pmatrix} 0 & 0 \\ 0 & \omega \end{pmatrix}. \quad (2.120)$$

We now set up a path integral formalism to describe the system. It is convenient to introduce a GRASSMANN variable  $\theta$ . Define states

$$|\theta\rangle = |0\rangle + \theta|1\rangle, \quad \langle\bar{\theta}| = \langle 0| + \bar{\theta}\langle 1|, \quad (2.121)$$

and note that  $(\theta^2 = 0 = \bar{\theta}^2)$

$$\hat{\mathbf{b}}|\theta\rangle = \theta|\theta\rangle, \quad \langle\bar{\theta}|\hat{\mathbf{b}}^\dagger = \bar{\theta}\langle\bar{\theta}|. \quad (2.122)$$

These are analogous to the states  $|z\rangle$  which satisfy  $\hat{\mathbf{a}}|z\rangle = z|z\rangle$  for the bosonic oscillator. Now we want to express the time evolution between these states

$$\langle\bar{\theta}|\exp(-i\hat{\mathbf{H}}t)|\theta\rangle = \langle 0|0\rangle + \bar{\theta}\theta\langle 1|e^{-i\omega t}|1\rangle = 1 + \bar{\theta}\theta e^{-i\omega t} = \exp(\bar{\theta}\theta e^{-i\omega t}), \quad (2.123)$$

in terms of a path integral by breaking up the time interval into small increments, just as we did when we first introduced path integrals. We need a completeness relation, which is given by

$$\int d\bar{\theta} d\theta e^{\theta\bar{\theta}}|\theta\rangle\langle\bar{\theta}| = \int d\bar{\theta} d\theta e^{\theta\bar{\theta}}(|0\rangle\langle 0| + \theta\bar{\theta}|1\rangle\langle 1|) = |0\rangle\langle 0| + |1\rangle\langle 1| = \hat{\mathbf{1}}, \quad (2.124)$$

where we dropped mixed terms like  $\bar{\theta}|0\rangle\langle 1|$  under the integral because they give no contribution. We can use this to construct the path integral:

$$\langle\bar{\theta}|\exp(-i\hat{\mathbf{H}}t)|\theta\rangle = \int d\bar{\theta}' d\theta' e^{\theta'\bar{\theta}'}\langle\bar{\theta}|\exp(-i\hat{\mathbf{H}}(t-t'))|\theta'\rangle\langle\bar{\theta}'|\exp(-i\hat{\mathbf{H}}t')|\theta\rangle. \quad (2.125)$$

This shows how to introduce an intermediate set of states to break up the time evolution into smaller parts.

### 2.3.3 Path Integral Formalism for FERMIONIC FIELDS

We want to express the exact result for a time evolution amplitude

$$\langle\bar{\theta}|\exp(-i\hat{\mathbf{H}}T)|\theta_0\rangle = 1 + \bar{\theta}\theta_0 e^{-i\omega T} = e^{\bar{\theta}\theta_0 e^{-i\omega T}} \quad (2.126)$$

in terms of a path integral, proceeding in a fashion analogous to the BOSONIC case. We write  $T = (N+1)\epsilon$ , being interested in the limit  $N \rightarrow \infty$ ,  $\epsilon \rightarrow 0$ . We introduce  $N$  sets of intermediate states and use the completeness relation (2.124) to obtain

$$\begin{aligned} \langle\bar{\theta}|\exp(-i\hat{\mathbf{H}}T)|\theta_0\rangle &= \int \left( \prod_{r=1}^N d\bar{\theta}_r d\theta_r e^{\theta_r\bar{\theta}_r} \langle\bar{\theta}_r|\exp(-i\hat{\mathbf{H}}\epsilon)|\theta_{r-1}\rangle \right) \langle\bar{\theta}|\exp(-i\hat{\mathbf{H}}\epsilon)|\theta_N\rangle \\ &\approx \int \prod_{r=1}^N d\bar{\theta}_r d\theta_r e^{iS}, \end{aligned} \quad (2.127)$$

where the exponential is

$$\begin{aligned} iS &= \sum_{r=1}^N (\theta_r\bar{\theta}_r + \bar{\theta}_r\theta_{r-1}e^{-i\omega\epsilon}) + \bar{\theta}\theta_N e^{-i\omega\epsilon} \\ &\approx \sum_{r=1}^N (\theta_r\bar{\theta}_r + \bar{\theta}_r\theta_{r-1}(1 - i\omega\epsilon)) + \bar{\theta}\theta_N(1 - i\omega\epsilon), \end{aligned} \quad (2.128)$$

the approximation being valid for small  $\epsilon$ . We can rewrite this as

$$S = \epsilon \sum_{i=1}^N \left( i\bar{\theta}_i \frac{\theta_i - \theta_{i-1}}{\epsilon} - \omega\bar{\theta}_i\theta_{i-1} \right) - i\bar{\theta}\theta_N. \quad (2.129)$$

Now we formally take the limit  $N \rightarrow \infty$ ,  $\epsilon \rightarrow 0$ ; the sum is essentially like the standard definition of an integral:

$$S \rightarrow \int_0^T dt (i\bar{\psi}(t)\dot{\psi}(t) - \omega\bar{\psi}(t)\psi(t)) - i\bar{\theta}\psi(T), \quad (2.130)$$

making the replacements  $\theta_r \rightarrow \psi(t_r)$ ,  $\bar{\theta}_r \rightarrow \bar{\psi}(t_r)$ , and where  $t_r = r\epsilon$  becomes a continuous variable in the limit and we have the conditions  $\psi(0) = \theta_0$ ,  $\bar{\psi}(T) = \bar{\theta}$ . This is now written as a path integral

$$\langle \bar{\theta} | \exp(-i\hat{H}T) | \theta_0 \rangle = \int d[\bar{\psi}] d[\psi] e^{iS[\psi, \bar{\psi}]}, \quad (2.131)$$

where the integration runs over all fermion fields  $\psi(t), \bar{\psi}(t)$  with  $\psi(0) = \theta_0$ ,  $\bar{\psi}(T) = \bar{\theta}$ . This is the *FERMIONIC path integral*.

The path integral can be shown to give the required answer for this free example in a direct way: expand  $\psi, \bar{\psi}$  about a classical path for which the action  $S$  is stationary, treat  $\psi$  and  $\bar{\psi}$  as independent fields. What are the equations that you get? If you vary  $\bar{\psi}$ , you get

$$i\dot{\psi}(t) = \omega\psi(t), \quad (2.132)$$

vary  $\psi$  to get (using integration by parts)

$$-i\dot{\bar{\psi}}(t) = \omega\bar{\psi}(t). \quad (2.133)$$

We can write down the classical solutions

$$\psi_c(t) = \theta_0 e^{-i\omega t}; \quad \bar{\psi}_c(t) = \bar{\theta} e^{i\omega(t-T)}. \quad (2.134)$$

It is an exercise to substitute this in so that the result for the action is

$$S_c \equiv S[\psi_c, \bar{\psi}_c] = -i\bar{\theta}\psi_c(T) = -i\bar{\theta}\theta_0 e^{-i\omega T}. \quad (2.135)$$

Now use the expansion

$$\psi(t) = \psi_c(t) + \xi(t), \quad \bar{\psi}(t) = \bar{\psi}_c(t) + \bar{\xi}(t), \quad (2.136)$$

and the fact that  $S$  is stationary for the classical path (s. above discussion for the BOSONIC harmonic oscillator), to state that

$$S[\psi, \bar{\psi}] = S[\psi_c, \bar{\psi}_c] + S[\xi, \bar{\xi}]. \quad (2.137)$$

Then the path integral will become

$$\int d[\bar{\psi}] d[\psi] e^{iS[\psi, \bar{\psi}]} = e^{iS_c} \int d[\bar{\xi}] d[\xi] e^{iS[\xi, \bar{\xi}]}. \quad (2.138)$$

Note that the integral is independent of  $\theta_0, \bar{\theta}$  and basically a constant so that it can be defined to be one. This will yield the result

$$\int d[\bar{\psi}] d[\psi] e^{iS[\psi, \bar{\psi}]} = e^{iS_c} = 1 + \bar{\theta}\theta_0 e^{-i\omega T}, \quad (2.139)$$

and we have reproduced the result derived before.

Note that we can rewrite

$$S[\psi, \bar{\psi}] = - \int_0^T dt \bar{\psi} D\psi - i\bar{\theta}\psi(T), \quad (2.140)$$

where  $D = -i\frac{d}{dt} + \omega$ , which is essentially the DIRAC<sup>29</sup> operator in one dimension. The integral that we have defined to be one is then generally equal to  $\det D$ .

Let us briefly generalise this to field theory; the essential idea was already contained in the simple example before. We are interested in integrals of the following form

$$\int d[\bar{\psi}] d[\psi] e^{iS}, \quad S = - \int d^d x \bar{\psi} D\psi, \quad (2.141)$$

<sup>29</sup>Dirac, Paul Adrien Maurice (1902-1984), Nobel Prize 1933, St. John's

where the generalisation is that the DIRAC operator in  $d$  dimensions is

$$D = \gamma \cdot \partial + m1, \quad (2.142)$$

with the DIRAC matrices  $\gamma^\mu$  satisfying

$$\{\gamma^\mu, \gamma^\nu\} = 2\eta^{\mu\nu}. \quad (2.143)$$

(Note that in the convention used herein,  $\eta^{00} = -1$ ,  $\eta^{ij} = \delta^{ij}$ .) As before,

$$\int d[\bar{\psi}] d[\psi] e^{iS} = \det D, \quad (2.144)$$

and for the free theory we may choose the normalisation such that  $\det D = 1$ .

### 2.3.4 Canonical Treatment

For the simple fermionic oscillator the Lagrangian is just

$$L = i\bar{\psi}\dot{\psi} - \omega\bar{\psi}\psi, \quad (2.145)$$

and we may define the canonical momentum associated with  $\psi$  by

$$p_\psi = \frac{\partial L}{\partial \dot{\psi}} = -i\bar{\psi}, \quad (2.146)$$

and Hamiltonian

$$H = p_\psi \dot{\psi} - L = \omega\bar{\psi}\psi. \quad (2.147)$$

In a quantum treatment  $\psi, \bar{\psi}$  become operators with anti-commutation relations at equal times

$$\{\hat{\psi}, \hat{\bar{\psi}}\} = \hat{\mathbf{1}}. \quad (2.148)$$

In this case

$$\hat{H} = \omega \hat{\bar{\psi}} \hat{\psi}, \quad (2.149)$$

and

$$[\hat{H}, \hat{\psi}] = -\omega \hat{\psi}, \quad [\hat{H}, \hat{\bar{\psi}}] = \omega \hat{\bar{\psi}}. \quad (2.150)$$

### 2.3.5 Propagators

This is the situation for free fields. We define a *propagator*

$$iS_F(x-y)_{\alpha\beta} := \langle \psi_\alpha(x) \bar{\psi}_\beta(y) \rangle = \frac{1}{\det D} \int d[\bar{\psi}] d[\psi] \psi_\alpha(x) \bar{\psi}_\beta(y) e^{iS}, \quad (2.151)$$

where  $S_F$  is the FEYNMAN *propagator* for FERMIONS. Let us follow the same procedure which we considered in the BOSONIC case to derive the form of the propagator. Apply the DIRAC operator to the propagator, suppressing spinor indices:

$$\begin{aligned} -D_x \langle \psi(x) \bar{\psi}(y) \rangle &= \frac{1}{\det D} \int d[\bar{\psi}] d[\psi] \frac{\delta S}{\delta \bar{\psi}(x)} e^{iS} \bar{\psi}(y) \\ &= \frac{1}{\det D} \int d[\bar{\psi}] d[\psi] (-i) \left( \frac{\delta}{\delta \bar{\psi}(x)} e^{iS} \right) \bar{\psi}(y) \\ &= \frac{1}{\det D} \int d[\bar{\psi}] d[\psi] i e^{iS} \frac{\delta}{\delta \bar{\psi}(x)} \bar{\psi}(y) \\ &= i 1 \delta^d(x-y), \end{aligned} \quad (2.152)$$

where we have used the fact that  $D_x \psi(x) = -\frac{\delta}{\delta \bar{\psi}(x)} S$  and integrated by parts. We need to solve the differential equation

$$-D_x S_F(x-y) = 1 \delta^d(x-y), \quad (2.153)$$

and therefore use FOURIER transforms, as before. The FOURIER transform is defined by

$$\tilde{S}_F(p) = \int d^d x e^{-ip \cdot x} S_F(x), \quad (2.154)$$

which gives the equation for  $\tilde{S}_F$

$$(-i\gamma \cdot p - m1)\tilde{S}_F(p) = 1. \quad (2.155)$$

To solve that we make use of the identity

$$(-i\gamma \cdot p + m1)(-i\gamma \cdot p - m1) = -(\gamma \cdot p)^2 - m^2 1 = (-p^2 - m^2)1, \quad (2.156)$$

so that

$$(-p^2 - m^2)\tilde{S}_F(p) = -i\gamma \cdot p + m1, \quad (2.157)$$

$$\tilde{S}_F(p) = \frac{-i\gamma \cdot p + m1}{-p^2 - m^2 + i\epsilon}. \quad (2.158)$$

The diagrams representing propagators are drawn as before, with a propagator

$$\langle \psi_\alpha(x) \bar{\psi}_\beta(y) \rangle = iS_F(x-y)_{\alpha\beta} \quad (2.159)$$

being represented by a line

$$\begin{array}{c} \alpha \longrightarrow \beta \\ x \longleftarrow y \end{array}$$

while a propagator

$$\langle \bar{\psi}_\gamma(x) \psi_\delta(y) \rangle = -iS_F(y-x)_{\delta\gamma} \quad (2.160)$$

is represented by

$$\begin{array}{c} \gamma \longrightarrow \delta \\ x \longrightarrow y \end{array}$$

Besides the Fermion fields by themselves it is necessary to consider operators formed by products such as  $\bar{\psi}M\psi$  where  $M$  is some Dirac matrix. The electromagnetic current for charged Fermions is of this form with  $M \rightarrow \gamma^\mu$ . We may then consider correlation functions involving such operators at different points. Even for free fields these are more complicated. For the simplest case of two such operators we obtain

$$\langle \bar{\psi}(x)M\psi(x) \bar{\psi}(y)M'\psi(y) \rangle = \text{tr}(MS_F(x-y)M'S_F(y-x)) \quad (2.161)$$

using the above results for the propagators for  $\psi(x)\bar{\psi}(y)$  and  $\psi(y)\bar{\psi}(x)$  where it is also necessary to include also a minus sign to take account of the anti-commuting properties of the Fermion fields. In calculating this result we neglect contributions involving the propagator for  $\psi(x)\bar{\psi}(x)$ , proportional to  $S_F(0)$  which is divergent. In terms of Feynman diagrams this result is represented by

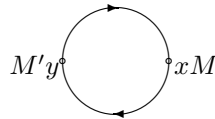

which describes a Fermion loop. In general for any Feynman diagram with closed Fermion loops the Feynman rules require that there is an additional minus sign for each such loop.

### 3 Operator Aspects of Quantum Field Theory

Many aspects of quantum field theories require an understanding of how the fields and operators constructed from them act on the space of states formed by all multi-particle states. It is also necessary to understand the role of symmetries.

#### 3.1 Symmetries and NOETHER'S theorem

Continuous symmetries, which form LIE groups, lead to relations between correlation functions of fields. To derive these we first consider a crucial result in classical dynamics. NOETHER<sup>30</sup> showed that when an action has a continuous symmetry, there is a conserved current and a corresponding conserved charge.

##### Proof

Assume that there is a continuous symmetry of the classical theory. The symmetry transformations act on the fields such that they transform as

$$\phi \rightarrow \phi' = \phi + \delta_\epsilon \phi, \quad (3.1)$$

for  $\epsilon$  an infinitesimal parameter. If this is a symmetry this means that the action is invariant

$$\delta_\epsilon S[\phi] = 0. \quad (3.2)$$

Now allow  $\epsilon(x)$  to be a function of  $x$ ; in that case

$$\delta_\epsilon S[\phi] = - \int d^d x \partial_\mu \epsilon(x) j^\mu(x) \quad (3.3)$$

for some  $j^\mu$ , any contribution must involve a derivative of  $\epsilon$  since for  $\epsilon$  a constant the action is invariant (we can always discard total derivatives under the integral, this may introduce an ambiguity in  $j^\mu$  but this is not crucial.) If the equations of motion are obeyed then

$$\delta_\epsilon S[\phi] = 0, \quad (3.4)$$

for any  $\epsilon$  because this the action is stationary for arbitrary  $\delta\phi$  when  $\phi$  satisfies its equations of motion. Hence we must have

$$\partial_\mu j^\mu = 0 \quad (3.5)$$

subject to the equations of motion. A conserved charge is then given by

$$q = \int d^{d-1} x j^0(x), \quad (3.6)$$

since  $\dot{Q} = - \int d^{d-1} x \vec{\nabla} \cdot \vec{j}(x) = 0$ . □

In a quantum treatment the charge becomes an operator such that

$$[\epsilon \hat{Q}, \hat{\phi}(x)] = i \delta_\epsilon \hat{\phi}(x). \quad (3.7)$$

As an illustration let  $\mathcal{L} = -\partial^\mu \phi^* \partial_\mu \phi - V(\phi^* \phi)$ . This has a symmetry corresponding to  $U(1)$  transformations  $\delta_\epsilon \phi = i\epsilon \phi$ ,  $\delta_\epsilon \phi^* = -i\epsilon \phi^*$  and the corresponding conserved current is then  $j^\mu = i(\partial^\mu \phi^* \phi - \phi^* \partial^\mu \phi)$ . In this case  $[\hat{Q}, \hat{\phi}(x)] = -\hat{\phi}(x)$ .

#### 3.2 WARD Identities

In a quantum field theory there are Ward<sup>31</sup> identities associated with symmetries for correlation functions. In general we consider

$$\langle X \rangle = \frac{1}{Z} \int d[\phi] X(\phi) e^{iS[\phi]}, \quad (3.8)$$

<sup>30</sup>Noether, Emmy (1882-1935)

<sup>31</sup>Ward, John Clive (1924-2000), unfortunately no Nobel Prize

where  $X(\phi)$  is a function of the fields, e.g.  $X(\phi) = \phi(x_1)\phi(x_2)\dots$ . Let us suppose that under the transformation  $\phi \rightarrow \phi'$ ,

$$X \rightarrow X' = X(\phi') = X + \delta_\epsilon X, \quad (3.9)$$

and since the functional integral does not depend on the choice of variable

$$\int d[\phi'] X' e^{iS[\phi']} = \int d[\phi] X e^{iS[\phi]}. \quad (3.10)$$

We then expand the left-hand side in  $\epsilon$ , assuming invariance of the measure  $d[\phi'] = d[\phi]$ , with the implications,

$$\int d[\phi'] X' e^{iS[\phi']} = \int d[\phi] (X + \delta_\epsilon X) e^{iS[\phi]} \left( 1 - i \int d^d x \partial_\mu \epsilon j^\mu \right) + O(\epsilon^2), \quad (3.11)$$

and this then requires

$$\langle \delta_\epsilon X \rangle = i \int d^d x \partial_\mu \epsilon(x) \langle j^\mu(x) X \rangle. \quad (3.12)$$

Taking a functional derivative with respect to  $\epsilon(x)$  on both sides, we obtain a WARD identity

$$\boxed{\frac{\delta}{\delta \epsilon(x)} \langle \delta_\epsilon X \rangle = -i \partial_\mu \langle j^\mu(x) X \rangle.} \quad (3.13)$$

WARD first emphasised this in a particular example in quantum electrodynamics where it played a crucial role in understanding renormalisation since it showed two divergent renormalisation constants were equal. Integrating over  $x$ , we obtain

$$\int d^d x \frac{\delta}{\delta \epsilon(x)} \langle \delta_\epsilon X \rangle = 0, \quad (3.14)$$

or for constant  $\epsilon$ ,

$$\frac{\partial}{\partial \epsilon} \langle \delta_\epsilon X \rangle = 0. \quad (3.15)$$

This argument, however, is by no means watertight. It may fail for two reasons, which are essentially related;

- (i) we assumed invariance of the measure  $d[\phi] = d[\phi']$ ;
- (ii) the functional integral is not defined without regularisation, and you have to check whether the regularisation also satisfies the symmetries otherwise this might lead to *anomalies*.

### 3.3 Energy Momentum Tensor

In any relativistic quantum field theory the energy momentum tensor plays a crucial role. From it the momentum operator, the angular momentum operators and the generators of Lorentz boosts can be constructed. The Noether procedure can be adapted to determine the form of the energy momentum starting from an action which is invariant under translations and Lorentz transformations.

First we consider just translations. For a translation invariant theory the action is invariant under infinitesimal translations so that

$$\delta_a \phi = a^\mu \partial_\mu \phi \quad \Rightarrow \quad \delta_a S[\phi] = 0, \quad (3.16)$$

for constant infinitesimal  $d$ -vectors  $a^\mu$ . If  $a^\mu$  is allowed to depend on  $x$  this implies

$$\delta_a S[\phi] = - \int d^d x \partial_\mu a^\nu(x) T^\mu{}_\nu(x), \quad (3.17)$$

and as before when the equations of motion are satisfied so that  $S$  is stationary then  $T^\mu{}_\nu$  is conserved and the momentum operator is defined by a spatial integral

$$\partial_\mu T^\mu{}_\nu = 0, \quad P_\mu = \int d^{d-1} x T^0{}_\mu(x). \quad (3.18)$$

However in relativistic quantum field theories the energy momentum tensor should be symmetric  $\Theta^{\mu\nu} = \Theta^{\nu\mu}$ , as required for coupling to gravity. To construct  $\Theta^{\mu\nu}$  from  $S$  we must also consider Lorentz transformations. In general these act on the fields according to

$$\delta_\omega \phi = \omega^\mu{}_\nu x^\nu \partial_\mu \phi + \frac{1}{2} \omega^{\mu\nu} s_{\mu\nu} \phi, \quad \omega_{\mu\nu} = -\omega_{\nu\mu}, \quad (3.19)$$

where  $s_{\mu\nu} = -s_{\nu\mu}$  are the spin generators acting on  $\phi$ . These are matrices satisfying the commutation relations

$$[s_{\mu\nu}, s_{\sigma\rho}] = \eta_{\mu\sigma} s_{\nu\rho} - \eta_{\nu\sigma} s_{\mu\rho} - \eta_{\mu\rho} s_{\nu\sigma} + \eta_{\nu\rho} s_{\mu\sigma}, \quad (3.20)$$

so that

$$(\delta_{\omega'} \delta_\omega - \delta_\omega \delta_{\omega'}) \phi = \delta_{[\omega', \omega]} \phi, \quad [\omega', \omega]^\mu{}_\nu = \omega'^\mu{}_\sigma \omega^\sigma{}_\nu - \omega^\mu{}_\sigma \omega'^\sigma{}_\nu. \quad (3.21)$$

Lorentz and translation invariance ensures that the lagrangian density  $\mathcal{L}$  is a scalar so that

$$\delta_v \mathcal{L}(\phi, \partial\phi) = v^\mu \partial_\mu \mathcal{L}(\phi, \partial\phi), \quad v_\mu(x) = a_\mu + \omega_{\mu\nu} x^\nu, \quad (3.22)$$

where  $\delta_v \phi$  is defined by combining  $\delta_a \phi$  and  $\delta_\omega \phi$  and  $\delta_v \partial\phi = \partial(\delta_v \phi)$ . Note that

$$\partial_\mu v_\nu(x) + \partial_\nu v_\mu(x) = 0, \quad (3.23)$$

so that  $v_\mu(x)$  is a KILLING vector. For general  $v_\mu(x)$  and  $\omega_{\mu\nu}(x) = -\omega_{\nu\mu}(x)$  then we can write

$$\delta_{v,\omega} S[\phi] = - \int d^d x \left( (\partial_\mu v_\nu + \omega_{\mu\nu}) T^{\mu\nu} + \partial_\sigma \omega_{\mu\nu} X^{\sigma\mu\nu} \right), \quad X^{\sigma\mu\nu} = -X^{\sigma\nu\mu}, \quad (3.24)$$

so that when  $v_\nu = a_\nu + \omega_{\nu\sigma} x^\sigma$  with  $a_\nu, \omega_{\mu\nu}$  constants then  $S$  is invariant. This determines  $T^{\mu\nu}$  but it is not in general symmetric. However if we define

$$\Theta^{\mu\nu} = T^{\mu\nu} - \partial_\sigma (X^{\sigma\mu\nu} - X^{\mu\sigma\nu} + X^{\nu\mu\sigma}), \quad (3.25)$$

then since

$$\begin{aligned} \int d^d x \partial_\mu v_\nu \partial_\sigma (X^{\sigma\mu\nu} - X^{\mu\sigma\nu} + X^{\nu\mu\sigma}) &= - \int d^d x (\partial_\sigma \partial_\mu v_\nu - \partial_\mu \partial_\sigma v_\nu + \partial_\mu \partial_\nu v_\sigma) X^{\sigma\mu\nu} = 0 \\ \int d^d x \omega_{\mu\nu} \partial_\sigma (X^{\sigma\mu\nu} - X^{\mu\sigma\nu} + X^{\nu\mu\sigma}) &= - \int d^d x \partial_\sigma \omega_{\mu\nu} X^{\sigma\mu\nu}, \end{aligned} \quad (3.26)$$

the invariance condition becomes

$$\delta_{v,\omega} S[\phi] = - \int d^d x (\partial_\mu v_\nu + \omega_{\mu\nu}) \Theta^{\mu\nu}. \quad (3.27)$$

For  $\phi$  satisfying the equations of motion  $\delta S[\phi] = 0$  for any  $\delta\phi$  so that then  $\delta_{v,\omega} S[\phi] = 0$ . Since  $v_\mu(x), \omega_{\mu\nu}(x)$  are arbitrary this gives, subject to the equations of motion,

$$\boxed{\partial_\mu \Theta^{\mu\nu} = 0, \quad \Theta^{\mu\nu} = \Theta^{\nu\mu}.} \quad (3.28)$$

If we define

$$\mathcal{M}^{\sigma\mu\nu} = x^\mu \Theta^{\sigma\nu} - x^\nu \Theta^{\sigma\mu}, \quad (3.29)$$

then the symmetry and conservation equations imply

$$\partial_\sigma \mathcal{M}^{\sigma\mu\nu} = 0. \quad (3.30)$$

Alternatively let

$$J_v^\mu = v_\nu \Theta^{\mu\nu} \quad \Rightarrow \quad \partial_\mu J_v^\mu = 0 \quad \text{for } v_\mu \text{ a Killing vector.} \quad (3.31)$$

This allows us to define the Lorentz generators by

$$M^{\mu\nu} = \int d^{d-1} x \mathcal{M}^{0\mu\nu}. \quad (3.32)$$



Ward identities for the energy momentum tensor can be derived in a similar fashion as for conserved currents. It is convenient first to assume the energy momentum tensor is symmetric and require

$$\delta_v S[\phi] = - \int d^d x \partial_\mu v_\nu \Theta^{\mu\nu} \quad \text{for} \quad \delta_v \phi = v^\mu \partial_\mu \phi - \frac{1}{2} \partial^\mu v^\nu s_{\mu\nu} \phi. \quad (3.33)$$

Then the Ward identities come from

$$\langle \delta_v X \rangle = i \int d^d x \partial_\mu v_\nu(x) \langle \Theta^{\mu\nu}(x) X \rangle. \quad (3.34)$$

If  $v_\nu$  is a Killing vector this just says that  $\langle \delta_v X \rangle = 0$ . For general  $v_\nu(x)$  we may obtain the Ward identity

$$\frac{\delta}{\delta v_\nu(x)} \langle \delta_v X \rangle = -i \partial_\mu \langle \Theta^{\mu\nu}(x) X \rangle. \quad (3.35)$$

### 3.4 Relation of $n$ -Point Functions and Scattering Amplitudes

We go back to the case of just BOSONIC fields, having dealt with FERMIONIC fields in the last section. Consider the identity

$$\langle \phi(x_1) \dots \phi(x_n) \rangle = \langle 0 | T \{ \hat{\phi}(x_1) \dots \hat{\phi}(x_n) \} | 0 \rangle, \quad (3.36)$$

where  $\hat{\phi}$  denotes the HEISENBERG<sup>32</sup> operator fields.

We would like to be able to talk about scattering amplitudes, which are measurable quantities:

$$2 \text{ particles} \rightarrow \text{many}. \quad (3.37)$$

First of all, we need to find a representation for the case of two particles  $\langle \phi(x_1) \phi(x_2) \rangle$ , which incorporates standard field theory and LORENTZ invariance. We use operator methods and look at the operator fields  $\hat{\phi}$ . We have the *momentum operator*

$$\hat{P}^\mu = (\hat{H}, \hat{P}), \quad (3.38)$$

with the commutator

$$[\hat{P}_\mu, \hat{\phi}(x)] = i \partial_\mu \hat{\phi}(x). \quad (3.39)$$

In a sense, you can always solve this in terms of the field at the origin

$$\hat{\phi}(x) = \exp(-i \hat{P} \cdot x) \hat{\phi}(0) \exp(i \hat{P} \cdot x). \quad (3.40)$$

We assume to have a complete set of states, such that

$$\hat{1} = \sum_n |n\rangle \langle n|. \quad (3.41)$$

Consider the following quantity (for a given  $d$ -vector  $p$ ):

$$\begin{aligned} \int d^d x \langle 0 | \hat{\phi}(0) \hat{\phi}(x) | 0 \rangle e^{ip \cdot x} &= \sum_n \int d^d x \langle 0 | \hat{\phi}(0) | n \rangle \langle n | \hat{\phi}(x) | 0 \rangle e^{ip \cdot x} \\ &= \sum_n \int d^d x e^{i(p - P_n) \cdot x} \langle 0 | \hat{\phi}(0) | n \rangle \langle n | \hat{\phi}(0) | 0 \rangle \\ &= (2\pi)^d \sum_n \delta^d(p - P_n) |\langle n | \hat{\phi}(0) | 0 \rangle|^2, \end{aligned} \quad (3.42)$$

where  $\hat{P}^\mu |0\rangle = 0$  and  $\hat{P}^\mu |n\rangle = P_n^\mu |n\rangle$  are used. The summation is constrained by virtue of the delta function. There will only be a non-zero contribution if  $p^0 > 0$  since the states have positive energy; furthermore it is a LORENTZ scalar and it is convenient to write this as

$$\int d^d x \langle 0 | \hat{\phi}(0) \hat{\phi}(x) | 0 \rangle e^{ip \cdot x} = 2\pi \theta(p^0) \rho(-p^2), \quad (3.43)$$

<sup>32</sup>Heisenberg, Werner (1901-1976), Nobel Prize 1932

where  $\theta(p^0)$  is a step function and  $\rho(-p^2)$  is a function which can only be non-zero for  $-p^2 > 0$ , since  $P_n^2 < 0$ . We also have  $\rho(-p^2) \geq 0$ . In a corresponding fashion we also have

$$\int d^d x \langle 0 | \hat{\phi}(x) \hat{\phi}(0) | 0 \rangle e^{ip \cdot x} = (2\pi)^d \sum_n \delta^d(p + P_n) |\langle n | \hat{\phi}(0) | 0 \rangle|^2 = 2\pi \theta(-p^0) \rho(-p^2). \quad (3.44)$$

These results then allow us to obtain a formula for the time-ordered product by inverting the FOURIER transform:

$$\langle 0 | T \{ \hat{\phi}(0) \hat{\phi}(x) \} | 0 \rangle = 2\pi \int \frac{d^d p}{(2\pi)^d} e^{-ip \cdot x} \rho(-p^2) (\theta(-x^0) \theta(p^0) + \theta(x^0) \theta(-p^0)), \quad (3.45)$$

which combines the two separate cases for  $x^0 > 0$  and  $x^0 < 0$  together. In order to separate the dependence on  $\rho$  we introduce another integration variable so that:

$$\langle 0 | T \{ \hat{\phi}(0) \hat{\phi}(x) \} | 0 \rangle = 2\pi \int_0^\infty d\sigma \rho(\sigma) \int \frac{d^d p}{(2\pi)^d} e^{-ip \cdot x} \delta(p^2 + \sigma) (\theta(-x^0) \theta(p^0) + \theta(x^0) \theta(-p^0)). \quad (3.46)$$

It is now possible to carry out the  $p^0$  integration using the delta function; we get a contributions for  $p^0 = \pm E_p := \pm \sqrt{\sigma + \vec{p}^2}$ , but only one contributes in each term because of the step function. This gives

$$\langle 0 | T \{ \hat{\phi}(0) \hat{\phi}(x) \} | 0 \rangle = \int_0^\infty d\sigma \rho(\sigma) \int \frac{d^{d-1} p}{(2\pi)^{d-1}} \frac{e^{-i\vec{p} \cdot \vec{x}}}{2E_{\vec{p}}} \left( \theta(-x^0) e^{iE_{\vec{p}} x^0} + \theta(x^0) e^{-iE_{\vec{p}} x^0} \right). \quad (3.47)$$

Note that this expression is almost identical to our expression for the FEYNMAN propagator for free scalar field theory, so reiterating the calculation we did then we get

$$\boxed{\langle 0 | T \{ \hat{\phi}(0) \hat{\phi}(x) \} | 0 \rangle = \int_0^\infty d\sigma \rho(\sigma) (-i) \int \frac{d^d p}{(2\pi)^d} \frac{e^{-ip \cdot x}}{p^2 + \sigma - i\epsilon}.} \quad (3.48)$$

This is a sum of FEYNMAN propagators for different values of  $m^2$ .

The formula is valid for any field theory incorporating the assumption of LORENTZ invariance and so on.

We now determine the contribution of a single particle to the sum over states. Remember that the function  $\rho(-p^2)$  was defined by

$$2\pi \theta(p^0) \rho(-p^2) = \sum_n (2\pi)^d \delta^d(p - P_n) |\langle n | \hat{\phi}(0) | 0 \rangle|^2. \quad (3.49)$$

Let  $|\vec{P}\rangle$  be a single-particle state, satisfying  $-P^2 = m^2$  and  $P^0 > 0$ . We use the convention for normalisation of single-particle states

$$\langle \vec{P}' | \vec{P} \rangle = (2\pi)^{d-1} (2E_{\vec{P}}) \delta^{d-1}(\vec{P}' - \vec{P}). \quad (3.50)$$

Suppose that

$$\langle \vec{P} | \hat{\phi}(0) | 0 \rangle = N, \quad (3.51)$$

where  $N$  is a scalar that only depends on  $P^2 = -m^2$ , and so is essentially independent on  $P$ . The contribution to the sum which results from this particular particle may be isolated explicitly:

$$\sum_n |n\rangle \langle n| = \int \frac{d^{d-1} P}{(2\pi)^{d-1}} \frac{1}{2E_{\vec{P}}} |\vec{P}\rangle \langle \vec{P}| + \dots \quad (3.52)$$

To find the contribution to  $\rho(-p^2)$ , consider the following integral, obtained by inserting the above relation into the defining relation for  $\rho$ :

$$\begin{aligned} \sum_n (2\pi)^d \delta^d(p - P_n) |\langle n | \hat{\phi}(0) | 0 \rangle|^2 &= \int \frac{d^{d-1}P}{(2\pi)^{d-1}} \frac{1}{2E_{\vec{P}}} (2\pi)^d \delta^d(p - P) |\langle \vec{P} | \hat{\phi}(0) | 0 \rangle|^2 \\ &= N^2 (2\pi) \frac{1}{2E_{\vec{p}}} \delta(p^0 - E_{\vec{p}}) \\ &= N^2 2\pi \delta(p^2 + m^2) \theta(p^0), \end{aligned} \quad (3.53)$$

where  $E_{\vec{p}} = \sqrt{m^2 + \vec{p}^2}$ . This requires  $\rho(-p^2) = \delta(p^2 + m^2) N^2$  or

$$\rho(\sigma) = \delta(\sigma - m^2) N^2. \quad (3.54)$$

What implication does this have for the time-ordered expression? Consider

$$\int d^d x \langle 0 | T \{ \hat{\phi}(0) \hat{\phi}(x) \} | 0 \rangle e^{ip \cdot x} = -i \int_0^\infty d\sigma \rho(\sigma) \frac{1}{p^2 + \sigma - i\epsilon} \sim -i \frac{N^2}{p^2 + m^2} + \dots, \quad (3.55)$$

where ... includes contributions whose singularities arise for  $-p^2 > m^2$ . In general  $n$ -particle states contribute to  $\rho(\sigma)$  only when  $\sigma \geq (nm)^2$  and these give rise to branch cuts in (3.55) with branch points at  $-p^2 = (nm)^2$ .

Hence single particle states give rise an isolated pole at  $p^2 = -m^2$ , which we express as this as

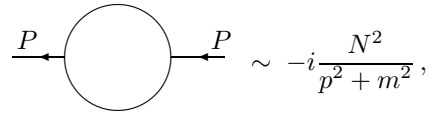

$$\text{Diagram} \sim -i \frac{N^2}{p^2 + m^2},$$

where  $\sim$  means that only single-particle contributions are considered.

Let us show how we can now relate the amplitudes including fields to scattering amplitudes. Consider the integral

$$\int d^d x \langle \beta | \hat{\phi}(x) | \alpha \rangle_{\text{conn.}} e^{ip \cdot x}, \quad (3.56)$$

corresponding to the picture

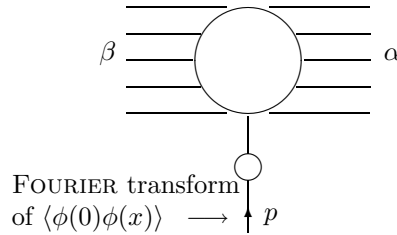

We have an external line corresponding to  $\hat{\phi}$ , with an associated momentum  $p$ . The amplitude contains a factor  $\int d^d x \langle \phi(0) \phi(x) \rangle e^{ip \cdot x}$  which corresponding to all one particle reducible graphs connected to this external line. As we have seen, this has a pole for  $p^2 \rightarrow -m^2$  resulting from the contribution of the single-particle state  $|\vec{p}\rangle$ , which is only defined for physical momenta such that  $-p^2 = m^2$ , to the sum over states. Acting on the vacuum state, to the right or to the left, the field  $\hat{\phi}$ , in a time ordered product, thus creates a single particle state so that

$$\begin{aligned} \int d^d x \hat{\phi}(x) | 0 \rangle e^{ip \cdot x} &\sim -\frac{i}{p^2 + m^2} |\vec{p}\rangle \langle \vec{p} | \hat{\phi}(0) | 0 \rangle, \quad p^0 > 0, \\ \int d^d x \langle 0 | \hat{\phi}(x) e^{ip \cdot x} &\sim -\frac{i}{p^2 + m^2} \langle 0 | \hat{\phi}(0) | -\vec{p}\rangle \langle -\vec{p} |, \quad p^0 < 0, \end{aligned} \quad (3.57)$$

as  $p^2 \rightarrow -m^2$ . A similar result holds also when  $\hat{\phi}$  acts on any state  $|\alpha\rangle$  to the right, giving  $|\alpha, \vec{p}\rangle$ , or equivalently on  $\langle\beta|$  to the left giving then  $\langle\beta, -\vec{p}|$ . Hence for the full amplitude there are poles at  $-p^2 = m^2$  corresponding to an additional incoming or outgoing particle, with momentum  $p$  or  $-p$ , so that

$$\int d^d x \langle\beta|\hat{\phi}(x)|\alpha\rangle_{\text{conn.}} e^{ip \cdot x} \sim \begin{cases} -i\langle\beta|\alpha, \vec{p}\rangle \frac{1}{p^2+m^2} \langle\vec{p}|\hat{\phi}(0)|0\rangle = -i\langle\beta|\alpha, \vec{p}\rangle \frac{N}{p^2+m^2} & \text{if } p^0 > 0, \\ -i\langle 0|\hat{\phi}(0)|-\vec{p}\rangle \frac{1}{p^2+m^2} \langle\beta, -\vec{p}|\alpha\rangle = -i\langle\beta, -\vec{p}|\alpha\rangle \frac{N}{p^2+m^2} & \text{if } p^0 < 0, \end{cases} \quad \text{as } -p^2 \rightarrow m^2. \quad (3.58)$$

Alternatively this can be written as

$$\langle\beta|\alpha, \vec{p}\rangle = \lim_{p^2 \rightarrow -m^2} \frac{i(p^2 + m^2)}{N} \int d^d x \langle\beta|\hat{\phi}(x)|\alpha\rangle e^{ip \cdot x}, \quad p^0 > 0, \quad (3.59)$$

with a similar result for  $\langle\beta, -\vec{p}|\alpha\rangle$  when  $p^0 < 0$ . This can be extended to arbitrarily many initial or final particles. For four the situation looks like this:

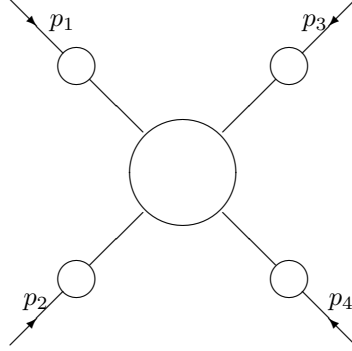

The analogous expression is

$$\int \prod_{i=1}^4 d^d x_i e^{ip_i \cdot x_i} \langle\phi(x_1)\phi(x_2)\phi(x_3)\phi(x_4)\rangle_{\text{conn.}} = i(2\pi)^d \delta^d(\sum_i p_i) \tau_4(p_1, p_2, p_3, p_4). \quad (3.60)$$

We claim that the scattering amplitude for physical particles is given by (e.g. for  $p_1^0, p_2^0 > 0$  and  $p_3^0, p_4^0 < 0$ )

$$\langle-\vec{p}_3, -\vec{p}_4|\hat{T}|\vec{p}_1, \vec{p}_2\rangle = \frac{i^4}{N^4} \lim_{p_1^2, p_2^2, p_3^2, p_4^2 \rightarrow -m^2} \prod_{i=1}^4 (p_i^2 + m^2) \tau_4(p_1, p_2, p_3, p_4). \quad (3.61)$$

## 4 Calculation of FEYNMAN Amplitudes and Divergences

This is a very broad subject, and there are very complicated methods for very complicated diagrams. We can only touch the surface here. Let us start with a LAGRANGIAN density

$$\mathcal{L} = -\frac{1}{2}\partial_\mu\phi\partial^\mu\phi - V(\phi). \quad (4.1)$$

The FEYNMAN rules for this theory in momentum space were derived above:

- For each internal line with associated momentum  $k$ , add a propagator

$$\frac{1}{k^2 + m^2 - i\epsilon}. \quad (4.2)$$

- For an external line with associated momentum  $p$ , add a propagator  $\frac{-i}{p^2+m^2}$ .
- For each vertex with  $n$  outgoing lines, add a factor  $-V^{(n)}(0)$ .
- Impose momentum conservation at each vertex.
- Add a factor  $-i$  for each loop and integrate over undetermined loop momenta  $\int \frac{d^d k}{(2\pi)^d}$ .
- There is an overall factor of  $i(2\pi)^d$  times a delta function imposing overall energy-momentum conservation.

For any graph, we denote the number of internal and external lines by  $I$  and  $E$ , the number of  $n$ -vertices by  $V_n$ , the total number of vertices by  $V$ , so that  $V = \sum_n V_n$ , and the number of loops by  $L$ .

### 4.1 Two Key Ideas

First of all let us describe a useful trick which simplifies things, the so-called WICK<sup>33</sup> rotation.

#### 4.1.1 WICK Rotation

Note that all propagators have singularities at  $k^2 + m^2 = 0$ . The actual FEYNMAN integrals define analytic functions, and one should think of all variables they depend on as being potentially complex. When we get poles in the propagator, these correspond to single-particle states; branch cuts correspond to multi-particle states.

Let us analyse the nature of these poles:

$$\frac{1}{k^2 + m^2 - i\epsilon} = \frac{1}{-(k^0)^2 + (E - i\epsilon)^2}, \quad E = \vec{k}^2 + m^2, \quad (4.3)$$

where  $\epsilon$  has been slightly redefined. This expression has poles at  $k^0 = \pm(E - i\epsilon)$ , as we can display in the complex  $k_0$  plane:

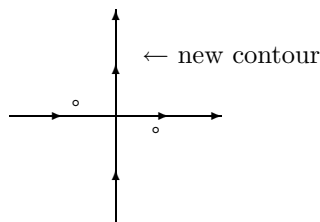

<sup>33</sup>Wick, Gian-Carlo (1909-1992)

We can rotate the  $k_0$  contour in a standard way to the imaginary axis

$$K_0 \rightarrow ik_d, \quad \text{where } k_d \text{ is real.} \quad (4.4)$$

You do this for all loop momenta; as long as there are no contributions at infinity you get the same answer. The propagator becomes

$$\frac{1}{-k_0^2 + \vec{k}^2 + m^2} \rightarrow \frac{1}{k_d^2 + \vec{k}^2 + m^2}, \quad \frac{d^d l}{i(2\pi)^d} \rightarrow \frac{d^{d-1} l dl_d}{(2\pi)^d}, \quad (4.5)$$

where  $l$  is any loop momentum. We can apply this to any integration and it simplifies calculations since all singularities have been removed. However there are slight caveats.

For the rotation to be consistent, we also have to rotate the external momenta to ensure momentum conservation, so we must require

$$(p_i^E)^2 > 0, \quad (4.6)$$

for each external line, and more generally for any subset of external lines

$$(\sum p_i^E)^2 > 0. \quad (4.7)$$

WICK rotation changes FEYNMAN amplitudes to integrals over EUCLIDEAN<sup>34</sup> space. We avoid discussing singularities when we want to determine the form of some amplitude.

*WICK rotations go from MINKOWSKI to EUCLIDEAN space.*

#### 4.1.2 Appearance of Divergences in FEYNMAN Integrals

Divergences may arise in integrating over  $L$  undetermined loop momenta according to the FEYNMAN rules. The basic integral we have to consider is (very schematically)

$$F = \int \frac{d^d L}{(2\pi)^d} \frac{1}{k^{2I}}, \quad (4.8)$$

where  $k = k(l)$  is typically linear in  $l$ , i.e.  $k \sim l + \text{other momenta}$ . When does such an integral diverge? Consider for  $\alpha > 0$  the finite integral

$$\int_0^\infty \frac{dx}{(x + \mu)^{\alpha+1}} = \frac{1}{\alpha} \mu^{-\alpha}. \quad (4.9)$$

This integral is divergent for  $\alpha \leq 0$  and the right-hand side expression has a pole at  $\alpha = 0$ . We define the *degree of divergence* of an integral  $F$  by

$$D = dL - 2I. \quad (4.10)$$

Evidently, if  $D \geq 0$ , then the integral  $F$  is divergent. In order to rewrite  $D$  in a slightly different form, we use Euler's formula (1.133), that is

$$L = I - V + 1,$$

together with the condition

$$\sum_n nV_n = 2I + E, \quad (4.11)$$

which states that each internal line is connected to two vertices and each external line is connected to one vertex. First we eliminate  $I$  from the definition of  $D$  in (4.10) to obtain

$$D = dL - \sum_n nV_n + E, \quad (4.12)$$

<sup>34</sup>Euclid of Alexandria (c. 330 BC-c. 275 BC)

and then combining (4.11) and (1.133) we find

$$2L = \sum_n nV_n - 2V - E + 2. \quad (4.13)$$

Now assuming  $d \approx 4$ , we add (4.12) and twice (4.13) to get the final result

$$D = (d - 4)L + \sum_n (n - 4)V_n - E + 4. \quad (4.14)$$

If the number of dimensions  $d$  is indeed equal to four, and we only have an interaction term  $V(\phi) = \frac{1}{24}\lambda\phi^4$ , then

$$D = 4 - E, \quad (4.15)$$

so  $D \geq 0$  for  $0 \leq E \leq 4$ ; graphs with more than four external lines are superficially finite, there may however still be divergences from subgraphs. The important thing to notice here is that  $D$  is independent of the number of loops; this will result in a *renormalisable* theory. (The meaning of this word will become apparent in due course.)

In the situation  $d \approx 3$ , we get the slightly different formula

$$D = (d - 3)L + \sum_n \left(\frac{1}{2}n - 3\right) V_n - \frac{1}{2}E + 3. \quad (4.16)$$

You can combine the formulae in various ways at your personal convenience, and here we have combined them in a way that brings out the point we want to make. For  $d = 3$  and only a  $\phi^6$  interaction we get

$$D = 3 - \frac{1}{2}E, \quad (4.17)$$

that is a divergence for not more than six external lines. Just as in the previous case, the theory will be *renormalisable*.

We can extend this to more complicated theories, e.g.

$$\mathcal{L} \sim \phi^2 \partial\phi + \phi^4, \quad (4.18)$$

which contains vertices

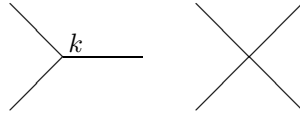

where a vertex of the first type has an associated momentum  $k$  because of the derivative appearing in the LAGRANGIAN. (We need not worry about the details for this point of view.) The basic integral is then of the following form:

$$\int \frac{d^dL}{(2\pi)^d} \frac{k^{V_3}}{k^{2I}}. \quad (4.19)$$

The definition for the quantity  $D$  is now modified from (4.10) to become

$$D = dL + V_3 - 2I, \quad (4.20)$$

since each three-edged vertex contributes a power of the momentum to the integral  $F$ ; eliminating  $I$ , we find the analogy of (4.12) is

$$D = dL - 2V_3 - 4V_4 + E. \quad (4.21)$$

The second equation we need is (4.13), which in our special case now reads

$$2L = \underbrace{V_3 + 2V_4}_{\sum_n nV_n - 2V} - E + 2. \quad (4.22)$$

We can combine these together to obtain

$$D = (d - 4)L + 4 - E, \quad (4.23)$$

and so  $D = 4 - E$  in the case  $d = 4$ . This corresponds to a *gauge theory*.

For completeness, let us give one example of a non-renormalisable theory: Consider an interaction of the following form

$$\mathcal{L} \sim \phi^{n-2}(\partial\phi)^2, \quad n = 2, 3, \dots, \quad (4.24)$$

which is indeed what you get when you apply the standard rules of quantisation to gravity. We have vertices with an arbitrary number of lines, with two associated momenta:

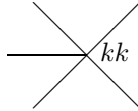

The basic integral

$$\int \frac{d^d L}{(2\pi)^d} \frac{k^{2V_n}}{k^{2I}} \quad (4.25)$$

has the degree of divergence

$$D = dL + 2V_n - 2I = (d - 2)L + 2. \quad (4.26)$$

Any graph in this example is divergent if  $d \geq 2$ , and  $D$  increases with  $L$ .

A few comments:

- For a renormalisable theory, if vertices of a certain type are present, e.g.  $V_3$  for  $d = 4$ , the degree of divergence is reduced. But for other types of vertices, e.g. if  $V_5 \neq 0$ , the theory becomes non-renormalisable.
- It is possible that  $D < 0$  for a graph but that there are subgraphs with  $D \geq 0$ ; then there are *sub-divergences*. For instance, consider  $\phi^4$  theory in four dimensions and a graph with external lines, so that  $D = -2$ :

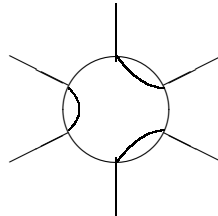

There are subgraphs

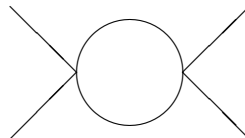

which have  $D = 0$  and are divergent.

We now consider  $\phi^4$  theory in four dimensions and one- and two-loop graphs. The number of external lines  $E$  must be even for any graph in this theory. Vacuum graphs ( $E = 0$ ) may be disregarded. Hence it is sufficient to consider just graphs with two and four external lines to get all divergences.

The one-loop graphs we find are



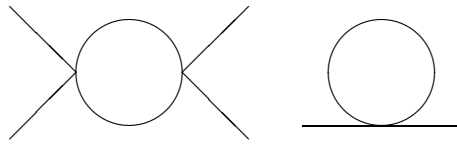

whilst the two-loop graphs with  $E = 2$  are

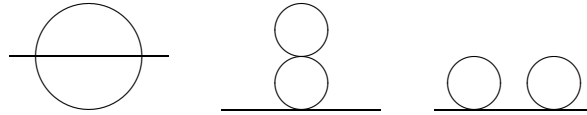

where the last one is one-particle reducible corresponding to two one-loop integrals; and finally for  $E = 4$  we get

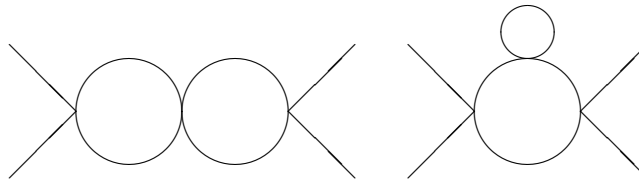

## 4.2 Regularisation

The critical thing to realise is that divergent integrals are meaningless; for unambiguous calculations, it is necessary to remove the divergences. They arise when the momentum goes to infinity, so we need to suppress the large  $k$  contribution to the integral. There is no unique prescription how to do this, and in the end, the exact method does not matter since they all lead to the same result. Different methods however may be more or less useful in doing calculations.

A simple procedure is introducing a momentum cut-off, after WICK rotation,

$$K^2 < \Lambda^2 \tag{4.27}$$

in all integrals. This is not very good in general because it produces more complicated integrals. Furthermore it is not systematic and does not respect the translation invariance ( $k \rightarrow k + k_0$ ) of infinite range integrals.

There are some desirable requirements for a regularisation scheme. A *good regularisation* should

- (i) be valid for arbitrary FEYNMAN graphs, to all orders of perturbation theory;
- (ii) respect the basic symmetries of the theory (this is very desirable), e.g. LORENTZ invariance;
- (iii) ideally be applicable outside perturbation theory since quantum field theories are not just a perturbation expansion.

We will now consider one particular process which will work at least in some theories. We modify the LAGRANGIAN

$$\mathcal{L} = -\frac{1}{2}\partial^\mu\phi \cdot P\left(-\frac{\partial^2}{\Lambda^2}\right)\partial_\mu\phi - V(\phi), \tag{4.28}$$

where  $P$  is some polynomial satisfying  $P(0) = 1$ . Suppose that the potential is of the form

$$V(\phi) = \frac{1}{2}m^2\phi^2 + O(\phi^3). \tag{4.29}$$

Note that the propagator is the inverse of the quadratic part of the LAGRANGIAN, so we can actually write down what the propagator is. After a FOURIER transform which transforms  $-\partial^2 \rightarrow k^2$ , we get

$$\frac{1}{k^2 P(\frac{k^2}{\Lambda^2}) + m^2} \sim \frac{1}{(k^2)^{h+1}} \text{ for large } k, \quad (4.30)$$

where we suppose that  $P$  is a polynomial of degree  $h$ . As  $\Lambda \rightarrow \infty$ , we recover the original propagator

$$\frac{1}{k^2 + m^2}. \quad (4.31)$$

For a finite value of  $\Lambda$  the divergences of FEYNMAN integrals are suppressed. To demonstrate this, we can consider a simple example; we set  $m = 0$  and  $P(\frac{k^2}{\Lambda^2}) = 1 + \frac{k^2}{\Lambda^2}$  and obtain the propagator

$$\frac{1}{k^2 (1 + \frac{k^2}{\Lambda^2})} = \frac{1}{k^2} - \frac{1}{\Lambda^2} \frac{1}{1 + \frac{k^2}{\Lambda^2}}. \quad (4.32)$$

The first part of that corresponds to a (physical) particle; the second part has a pole at  $k^2 = -\Lambda^2$  with negative residue, and so it is not a physical particle! Because of the wrong sign appearing in the propagator, you will get negative norm states and thus the theory with  $P \neq 1$  is not a physical theory. We need to take the limit  $\Lambda \rightarrow \infty$  to get a physical theory.

This method is complicated to calculate.

#### 4.2.1 Dimensional Regularisation for One-Loop Graphs

Another method that is frequently used is *dimensional regularisation*: Consider the theory in  $d$  dimensions, where the number  $d$  is a complex parameter. We can extend FEYNMAN graphs to arbitrary  $d$ , and the critical thing is that we will find that  $D < 0$  for sufficiently small  $d$ . We will define the FEYNMAN integrals by analytic continuation in  $d$ .

Let us first consider a more mundane example which will be useful for later calculations. The *Gamma function* is defined by

$$\Gamma(\alpha) = \int_0^\infty dx x^{\alpha-1} e^{-x}. \quad (4.33)$$

This is finite (i.e. well-defined) if  $\text{Re } \alpha > 0$  and diverges for  $\text{Re } \alpha \leq 0$ . But there is a standard procedure by which we can extend the definition to allow for an analytic continuation: rewrite the integral as

$$\Gamma(\alpha) = \frac{1}{\alpha} \int_0^\infty dx \left( \frac{d}{dx} x^\alpha \right) e^{-x} = \frac{1}{\alpha} [x^\alpha e^{-x}]_0^\infty + \frac{1}{\alpha} \int_0^\infty dx x^\alpha e^{-x} = \frac{1}{\alpha} \Gamma(\alpha + 1), \quad (4.34)$$

where we used integration by parts and assumed the surface term vanished since  $\text{Re } \alpha > 0$ . But since  $\Gamma(\alpha + 1)$  is given by a finite integral for  $\text{Re } \alpha > -1$ , we can use this relation to extend the definition of  $\Gamma(\alpha)$  to the region  $\text{Re } \alpha > -1$ . Since  $\Gamma(1) = 1$ , we get

$$\Gamma(\alpha) \sim_{\alpha \rightarrow 0} \frac{1}{\alpha}. \quad (4.35)$$

There is clearly a pole at  $\alpha = 0$  which reflects the divergence in the original integral. For applications later it is worth noting that the Gamma function may be expanded

$$\ln \Gamma(\alpha + 1) = -\gamma \alpha - \sum_{k \geq 2} (-1)^k \frac{1}{k} \zeta(k) \alpha^k, \quad (4.36)$$

where  $\gamma$  is EULER's number and  $\zeta(k) = \sum_{n \geq 1} n^{-k}$ .

We now calculate the FEYNMAN integrals for specific one and two loop FEYNMAN graphs focusing on those where there are divergencies. We consider only connected one-particle irreducible graphs, which are related to the generating functional  $\Gamma[\varphi]$ . We seek to calculate  $\hat{\tau}_n$  as

defined by,

$$\int \prod_{i=1}^n d^d x_i e^{ip_i \cdot x_i} \langle \phi(x_1) \dots \phi(x_n) \rangle_{\text{conn.,1PI}} = i(2\pi)^d \delta^d(\sum_i p_i) \hat{\tau}_n(p_1, \dots, p_n). \quad (4.37)$$

The FEYNMAN rules for the  $\hat{\tau}_n$  are

- Consider all connected one-particle irreducible graphs with  $n$  external lines.
- For each internal line there is a factor  $\frac{1}{k^2+m^2}$ .
- For each  $n$ -vertex add a factor  $-V_n(0)$  and impose conservation of momenta for all lines meeting at the vertex.
- Integrate over the independent loop momenta with

$$(-i) \int \frac{d^d l}{(2\pi)^d} \rightarrow \int \frac{d^d l}{(2\pi)^d}. \quad (4.38)$$

after WICK rotation.

- Add the appropriate symmetry factor  $\frac{1}{S}$  for the graph.

Note that there are no additional factors for external lines. For divergent Feynman integrals we need only consider  $n \leq 4$  and the calculations are manageable just for one and two loops.

Suppose we have a LAGRANGIAN of the form

$$\mathcal{L} = -\frac{1}{2} \partial_\mu \phi \partial^\mu \phi - \frac{1}{2} m^2 \phi^2 - \frac{1}{6} g \phi^3 - \frac{1}{24} \lambda \phi^4. \quad (4.39)$$

(The prefactors appearing in front of the interaction terms correspond to dividing by the order of the permutation group for each term; they ensure that the symmetry factors for each Feynman diagram are calculated as described previously.) For zero loops the non zero results are just (using superscripts to denote the number of loops)

$$\hat{\tau}_2^{(0)}(p, -p) = -p^2 - m^2, \quad (4.40a)$$

$$\hat{\tau}_4^{(0)}(p_1, p_2, p_3, p_4) = -\lambda, \quad (4.40b)$$

$$\hat{\tau}_3^{(0)}(p_1, p_2, p_3) = -g. \quad (4.40c)$$

Consider first one-loop diagrams for  $n = 2$ ; one contribution arises from the diagram

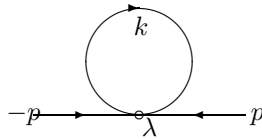

According to the FEYNMAN rules, it will be given by

$$\hat{\tau}_2^{(1)}(p, -p) = -\frac{\lambda}{2} \int \frac{d^d k}{(2\pi)^d} \frac{1}{k^2 + m^2}. \quad (4.41)$$

This is a EUCLIDEAN integration and the integrand has no angular dependence, which means we can replace the integration measure by

$$d^d k \rightarrow S_d |k|^{d-1} d|k|, \quad (4.42)$$

where  $S_d$  is a constant prefactor given by

$$S_1 = 2, \quad S_2 = 2\pi, \quad S_3 = 4\pi, \quad S_4 = 2\pi^2, \dots, \quad S_d = \frac{2\pi^{\frac{1}{2}d}}{\Gamma(\frac{d}{2})}. \quad (4.43)$$

To justify the result for general  $d$  consider the integral

$$\left(\frac{\pi}{\lambda}\right)^{\frac{d}{2}} = \int d^d k e^{-\lambda k^2} = S_d \int_0^\infty dk k^{d-1} e^{-\lambda k^2} \stackrel{k^2 \equiv u}{=} \frac{1}{2} S_d \int_0^\infty du u^{\frac{d}{2}-1} e^{-\lambda u} = S_d \frac{\Gamma(\frac{d}{2})}{2\lambda^{\frac{d}{2}}}, \quad (4.44)$$

set  $\lambda = 1$  to obtain the result. In consequence, we can say that

$$\hat{\tau}_2^{(1)}(p, -p) = -\frac{\lambda}{\Gamma(\frac{d}{2})} \frac{1}{(4\pi)^{\frac{d}{2}}} \int_0^\infty dk k^{d-1} \frac{1}{k^2 + m^2}. \quad (4.45)$$

Now in order to work out this integral, we need another trick; we can rewrite

$$\frac{1}{k^2 + m^2} = \int_0^\infty d\alpha e^{-\alpha(k^2 + m^2)}. \quad (4.46)$$

The integrals in this example are then just those defining the Gamma function:

$$\begin{aligned} \hat{\tau}_2^{(1)}(p, -p) &= -\frac{\lambda}{\Gamma(\frac{d}{2})} \frac{1}{(4\pi)^{\frac{d}{2}}} \int_0^\infty d\alpha \int_0^\infty dk k^{d-1} e^{-\alpha(k^2 + m^2)} \\ &\stackrel{k^2 \equiv u}{=} -\frac{\lambda}{2\Gamma(\frac{d}{2})} \frac{1}{(4\pi)^{\frac{d}{2}}} \int_0^\infty d\alpha e^{-\alpha m^2} \int_0^\infty du u^{\frac{d}{2}-1} e^{-\alpha u} \\ &= -\frac{\lambda}{2} \frac{1}{(4\pi)^{\frac{d}{2}}} \int_0^\infty d\alpha e^{-\alpha m^2} \frac{1}{\alpha^{\frac{d}{2}}}. \end{aligned} \quad (4.47)$$

Hence we obtain the final result for this one loop graph

$$\boxed{\hat{\tau}_2^{(1)}(p, -p) = -\frac{1}{2} \frac{\lambda}{(4\pi)^{\frac{d}{2}}} \Gamma\left(1 - \frac{d}{2}\right) (m^2)^{\frac{d}{2}-1}}. \quad (4.48)$$

Note that this result does not depend on the momentum  $p$  in any way.

The integral is divergent for  $d \geq 2$  which is consistent with the formula for the degree of divergence derived above; this is reflected in that  $\Gamma(1 - \frac{d}{2})$  has poles at  $d = 2$  and  $d = 4$ . To exhibit these we use the recurrence relation for Gamma functions to obtain

$$\Gamma(x-1) = -\frac{\Gamma(x)}{x-1} = -\frac{1}{x} e^{-\gamma x} (1 + x + O(x^2)), \quad (4.49)$$

in the limit  $x \rightarrow 0$ . Now let us consider

$$d = 4 - \varepsilon, \quad (4.50)$$

where in due course we will take the limit  $\varepsilon \rightarrow 0$ . Then we can use this expansion to rewrite

$$\Gamma\left(1 - \frac{d}{2}\right) = \Gamma\left(\frac{\varepsilon}{2} - 1\right) = -\frac{2}{\varepsilon} e^{-\frac{1}{2}\gamma\varepsilon} \left(1 + \frac{\varepsilon}{2} + O(\varepsilon^2)\right), \quad (4.51)$$

in (4.48), which gives the asymptotic expression for  $\hat{\tau}$  as  $\varepsilon \rightarrow 0$

$$\hat{\tau}_2^{(1)}(p, -p) \sim \frac{1}{2} \lambda \left(\frac{2}{\varepsilon} + 1\right) \frac{(m^2)^{\frac{d}{2}-1}}{(4\pi)^{\frac{d}{2}}} e^{-\frac{1}{2}\gamma\varepsilon} \sim \frac{1}{2} \frac{\lambda}{16\pi^2} m^2 \left(\frac{2}{\varepsilon} + 1 - \log m^2\right) \cdot [e^{-\gamma} 4\pi]^{\frac{1}{2}\varepsilon}. \quad (4.52)$$

In this result the divergent part, as a pole in  $\varepsilon$ , has been separated from the finite part. This is true generally using the method of dimensional regularisation for FEYNMAN integrals; the divergencies which may be present are reduced to poles in  $\varepsilon$ .

A rather more non-trivial one loop example corresponds to the graph

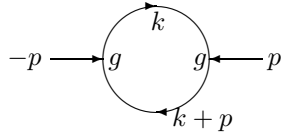

for which the associated Feynman integral is

$$\hat{\tau}_2^{(1)}(p, -p) = \frac{1}{2}g^2 \int \frac{d^d k}{(2\pi)^d} \frac{1}{(k^2 + m^2)((k+p)^2 + m^2)}. \quad (4.53)$$

To evaluate this we use

$$\frac{1}{x} = \int_0^\infty d\alpha e^{-\alpha x} \quad (4.54)$$

to rewrite the expression as

$$\hat{\tau}_2^{(1)}(p, -p) = \frac{1}{2}g^2 \int_0^\infty d\alpha_1 \int_0^\infty d\alpha_2 \int \frac{d^d k}{(2\pi)^d} e^{-\alpha_1(k^2+m^2) - \alpha_2((k+p)^2+m^2)}. \quad (4.55)$$

The exponent is then simplified by completing the square,

$$-\left( (\alpha_1 + \alpha_2)k'^2 + \frac{\alpha_1\alpha_2}{\alpha_1 + \alpha_2}p^2 + (\alpha_1 + \alpha_2)m^2 \right), \quad k' = k + \frac{\alpha_2}{\alpha_1 + \alpha_2}p. \quad (4.56)$$

Now we can shift the integral  $d^d k \rightarrow d^d k'$ ; there are no surface terms when  $d$  such that the integral is finite. The basic integral we need becomes

$$\int \frac{d^d k'}{(2\pi)^d} e^{-(\alpha_1+\alpha_2)k'^2} = \frac{1}{(4\pi)^{\frac{d}{2}}} \frac{1}{(\alpha_1 + \alpha_2)^{\frac{d}{2}}}, \quad (4.57)$$

and using this

$$\hat{\tau}_2^{(1)}(p, -p) = \frac{1}{2}g^2 \frac{1}{(4\pi)^{\frac{d}{2}}} \int_0^\infty d\alpha_1 \int_0^\infty d\alpha_2 \frac{1}{(\alpha_1 + \alpha_2)^{\frac{d}{2}}} e^{-\frac{\alpha_1\alpha_2}{\alpha_1+\alpha_2}p^2 - (\alpha_1+\alpha_2)m^2}. \quad (4.58)$$

The divergences which are present when  $d = 4$  arise from the singular behaviour of the integrand as  $\alpha_1, \alpha_2 \rightarrow 0$ . These may be exhibited explicitly, and the result reduced to a single integral, by making the substitution

$$\alpha_1 + \alpha_2 = s, \quad \alpha_1 = s\alpha, \quad \alpha_2 = s(1 - \alpha), \quad (4.59)$$

where  $0 < s < \infty$  and  $0 < \alpha < 1$ , and

$$d\alpha_1 d\alpha_2 = s ds d\alpha. \quad (4.60)$$

Hence we obtain

$$\hat{\tau}_2^{(1)}(p, -p) = \frac{1}{2}g^2 \frac{1}{(4\pi)^{\frac{d}{2}}} \int_0^1 d\alpha \int_0^\infty ds s^{1-\frac{d}{2}} e^{-s(\alpha(1-\alpha)p^2+m^2)}. \quad (4.61)$$

The  $s$  integral gives a Gamma function so the result becomes

$$\hat{\tau}_2^{(1)}(p, -p) = \frac{1}{2}g^2 \frac{1}{(4\pi)^{\frac{d}{2}}} \Gamma\left(2 - \frac{d}{2}\right) \int_0^1 d\alpha (\alpha(1-\alpha)p^2 + m^2)^{\frac{d}{2}-2}. \quad (4.62)$$

For  $d = 4 - \varepsilon$ , we want to find the leading terms as  $\varepsilon \rightarrow 0$ , if we are interested in the theory in four dimensions. We use the asymptotic form for  $x \rightarrow 0$

$$\Gamma(x) = \frac{1}{x} e^{-\gamma x} (1 + O(x^2)), \quad (4.63)$$

to obtain

$$\hat{\tau}_2^{(1)}(p, -p) \sim \frac{1}{2} \frac{g^2}{16\pi^2} \left( \frac{2}{\varepsilon} - \int_0^1 d\alpha \log(\alpha(1-\alpha)p^2 + m^2) \right) [e^{-\gamma} 4\pi]^{\frac{1}{2}\varepsilon}. \quad (4.64)$$

Again this is expressed in terms of a divergent pole term and a finite part. In this case the integral depends on the momentum, but the divergent part does not.<sup>35</sup>

Now consider  $n = 4$ , a  $\phi^4$  interaction and only one-loop graphs:

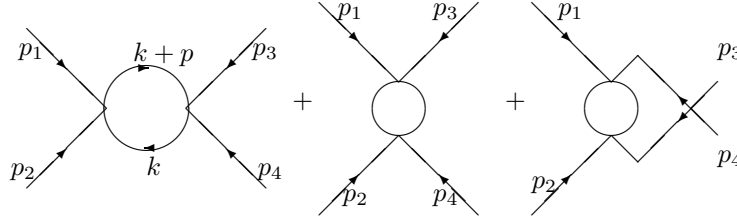

In this case we need to consider

$$\hat{\tau}_4^{(1)}(p_1, p_2, p_3, p_4) = \sum_{P=p_1+p_2, p_1+p_3, p_1+p_4} \frac{1}{2} \lambda^2 \int \frac{d^d k}{(2\pi)^d} \frac{1}{(k^2 + m^2)((k+P)^2 + m^2)}, \quad (4.65)$$

where the sum corresponds to the three one-loop graph contributions. The divergent part of the integral follows from previous calculations,

$$\hat{\tau}_4^{(1)}(p_1, p_2, p_3, p_4) \sim \frac{3}{2} \frac{\lambda^2}{16\pi^2} \frac{2}{\varepsilon}. \quad (4.66)$$

Other graphs are finite, for example

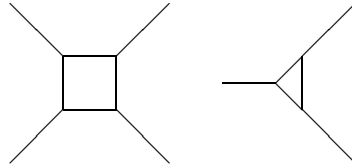

while these graphs with one three- and one four-point vertex also have a divergence

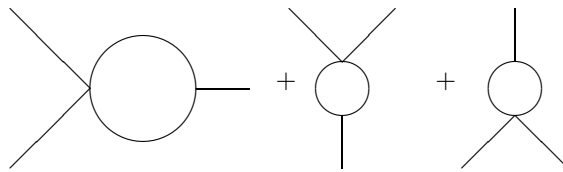

The divergent term will be of the order

$$\frac{3}{2} \frac{g\lambda}{16\pi^2} \frac{2}{\varepsilon}. \quad (4.67)$$

There is also a one loop graph with one external line

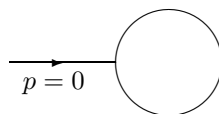

<sup>35</sup>One should be concerned that we take the logarithm of a dimensional quantity; we will come back to that later.

and the associated integral gives

$$\hat{\tau}_1^{(1)}(0) = -\frac{1}{2}g \int \frac{d^d k}{(2\pi)^d} \frac{1}{k^2 + m^2} \sim \frac{gm^2}{16\pi^2\varepsilon}. \quad (4.68)$$

Let us summarise the above one-loop results for the  $n$ -point functions  $\hat{\tau}_n^{(1)}(p_1, \dots, p_n)$ , neglecting the finite parts:

$$\hat{\tau}_1^{(1)}(0) \sim \frac{1}{16\pi^2\varepsilon} gm^2, \quad (4.69a)$$

$$\hat{\tau}_2^{(1)}(p, -p) \sim \frac{1}{16\pi^2\varepsilon} (\lambda m^2 + g^2), \quad (4.69b)$$

$$\hat{\tau}_3^{(1)}(p_1, p_2, p_3) \sim \frac{1}{16\pi^2\varepsilon} 3g\lambda, \quad (4.69c)$$

$$\hat{\tau}_4^{(1)}(p_1, p_2, p_3, p_4) \sim \frac{1}{16\pi^2\varepsilon} 3\lambda^2. \quad (4.69d)$$

If we had introduced a cutoff  $\Lambda$  instead of dimensional regularisation then we would effectively replace  $\frac{1}{\varepsilon}$  by  $\frac{1}{2} \log \Lambda^2$ .

The essential claim is, in a quantum field theory arising from a LAGRANGIAN  $\mathcal{L}$ , these divergent contributions can be cancelled by adding new terms to the LAGRANGIAN. When you first meet this, it may seem rather arbitrary, ad hoc and perhaps unremarkable, but there is a deep significance in that this can be carried out consistently to all orders of perturbation theory. The additional terms added to  $\mathcal{L}$  are termed *counterterms* and have the form

$$\mathcal{L}_{\text{c.t.}} = -A \frac{1}{2} \partial_\mu \phi \partial^\mu \phi - V_{\text{c.t.}}(\phi), \quad (4.70)$$

where  $V_{\text{c.t.}}$  is a local potential expressible in this theory as

$$V_{\text{c.t.}}(\phi) = E\phi + \frac{1}{2}B\phi^2 + \frac{1}{6}C\phi^3 + \frac{1}{24}D\phi^4. \quad (4.71)$$

For each term in  $\mathcal{L}_{\text{c.t.}}$  there are extra vertices which generate additional contributions. For those corresponding to tree-level diagrams we have

$$\begin{aligned} \hat{\tau}_2^{(0)}(p, -p)_{\text{c.t.}} &= -Ap^2 - B, & \hat{\tau}_4^{(0)}(p_1, p_2, p_3, p_4)_{\text{c.t.}} &= -D, \\ \hat{\tau}_1^{(0)}(0)_{\text{c.t.}} &= -E, & \hat{\tau}_3^{(0)}(p_1, p_2, p_3)_{\text{c.t.}} &= -C. \end{aligned} \quad (4.72)$$



We choose the coefficients to cancel the divergences. At this order,

$$\boxed{A^{(1)} = 0, \quad B^{(1)} = \frac{1}{16\pi^2\varepsilon} (\lambda m^2 + g^2), \quad C^{(1)} = \frac{1}{16\pi^2\varepsilon} 3g\lambda, \quad D^{(1)} = \frac{1}{16\pi^2\varepsilon} 3\lambda^2, \quad E^{(1)} = \frac{1}{16\pi^2\varepsilon} gm^2.} \quad (4.73)$$

Then  $\hat{\tau}_n^{(1)}(p_1, \dots, p_n) + \hat{\tau}_n^{(0)}(p_1, \dots, p_n)_{\text{c.t.}}$  has no pole in  $\varepsilon$  as  $\varepsilon \rightarrow 0$  and we may set  $\varepsilon = 0$  with a finite result.

More succinctly, all contributions to the one-loop counterterm potential can be written as

$$V_{\text{c.t.}}(\phi)^{(1)} = \frac{1}{32\pi^2\varepsilon} V''(\phi)^2. \quad (4.74)$$

To check that that is the case

$$V''(\phi) = m^2 + g\phi + \frac{1}{2}\lambda\phi^2, \quad (4.75)$$

$$V''(\phi)^2 = m^4 + 2m^2g\phi + (g^2 + \lambda m^2)\phi^2 + \lambda g\phi^3 + \frac{1}{4}\lambda^2\phi^4, \quad (4.76)$$

and the coefficients in  $V_{\text{c.t.}}(\phi)^{(1)}$  of  $\phi, \frac{1}{2}\phi^2, \frac{1}{6}\phi^3, \frac{1}{24}\phi^4$  match with  $E^{(1)}, B^{(1)}, C^{(1)}, D^{(1)}$  above. The LAGRANGIAN  $\mathcal{L} + \mathcal{L}_{\text{c.t.}}$  then ensures that all one-loop graphs are finite.

Let us make some remarks:

- (i)  $B, C, D$  and  $E$  are arbitrary to the extent that finite pieces can be added, but keeping just the poles in  $\varepsilon$  gives a unique prescription. This is in a way arbitrary, but sufficient.
- (ii) If  $V(\phi)$  is a polynomial of degree four in  $\phi$ , then so is  $V''(\phi)^2$ . As will be apparent later this is crucial in ensuring renormalisability of this theory.

#### 4.2.2 Dimensional Regularisation for Two-Loop Graphs

To show how divergencies can be consistently removed we need to proceed to higher numbers of loops,  $L \geq 2$ . The result that Feynman integrals can be regularised in a fashion consistent with the general requirements of quantum field theory is no longer almost a trivality but requires a careful analysis of the divergencies and also sub-divergencies in Feynman integrals. In terms of calculations, one-loop diagrams are fairly easy, sometimes calculating two loops is also straightforward, but just requires more work. Of course when quantum field theory calculations were first done in the 1940s, even one loop seemed to be hard, but now we know many techniques of how to do this.

Consider now  $\hat{\tau}_2^{(2)}(p, -p)$  with just a  $\phi^4$  interaction  $V(\phi) = \frac{1}{24}\lambda\phi^4$ . There are basically two two-loop diagrams:

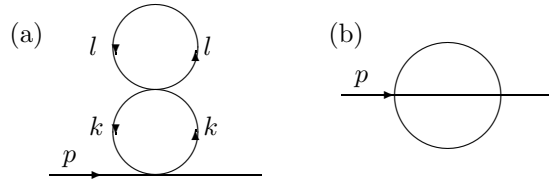

The contribution of the first diagram, after WICK rotation, is given by

$$\hat{\tau}_2^{(2)}(p, -p)_a = \frac{1}{4}\lambda^2 \int \frac{d^d k}{(2\pi)^d} \frac{1}{(k^2 + m^2)^2} \int \frac{d^d l}{(2\pi)^d} \frac{1}{l^2 + m^2}. \quad (4.77)$$

The two momentum integrals are independent so we can use

$$\begin{aligned} \int \frac{d^d l}{(2\pi)^d} \frac{1}{l^2 + m^2} &= \int_0^\infty d\alpha \int \frac{d^d l}{(2\pi)^d} e^{-\alpha(l^2 + m^2)} = \frac{1}{(4\pi)^{\frac{d}{2}}} \int_0^\infty d\alpha e^{-\alpha m^2} \frac{1}{\alpha^{\frac{d}{2}}} \\ &= \frac{1}{(4\pi)^{\frac{d}{2}}} \Gamma\left(1 - \frac{d}{2}\right) (m^2)^{\frac{d}{2} - 1}, \end{aligned} \quad (4.78)$$

as previously, and also

$$\begin{aligned} \int \frac{d^d k}{(2\pi)^d} \frac{1}{(k^2 + m^2)^2} &= -\frac{\partial}{\partial m^2} \int \frac{d^d k}{(2\pi)^d} \frac{1}{k^2 + m^2} \\ &= \frac{1}{(4\pi)^{\frac{d}{2}}} \Gamma\left(2 - \frac{d}{2}\right) (m^2)^{\frac{d}{2} - 2}. \end{aligned} \quad (4.79)$$

Both are expressible in terms of Gamma functions and hence we have the result

$$\hat{\tau}_2^{(2)}(p, -p)_a = \frac{1}{4}\lambda^2 \frac{1}{(4\pi)^d} \Gamma\left(2 - \frac{d}{2}\right) \Gamma\left(1 - \frac{d}{2}\right) (m^2)^{d-3} = \frac{1}{4}\lambda^2 \frac{1}{(4\pi)^d} \frac{\Gamma\left(2 - \frac{d}{2}\right)^2}{1 - \frac{d}{2}} (m^2)^{d-3} \quad (4.80)$$



Setting  $d = 4 - \varepsilon$  and using  $\Gamma(\frac{\varepsilon}{2}) \sim e^{-\frac{\gamma}{2}\varepsilon}(\frac{2}{\varepsilon} + O(\varepsilon))$  we obtain

$$\begin{aligned}\hat{\tau}_2^{(2)}(p, -p)_a &\sim -\frac{\lambda^2}{4(4\pi)^4}m^{2(1-\varepsilon)}\left(\frac{4}{\varepsilon^2} + \frac{2}{\varepsilon}\right)[e^{-\gamma}4\pi]^\varepsilon \\ &= -\frac{\lambda^2}{(4\pi)^4}m^2\left(\frac{1}{\varepsilon^2} + \frac{1}{2\varepsilon} - \frac{1}{\varepsilon}\log m^2\right)[e^{-\gamma}4\pi]^\varepsilon.\end{aligned}\quad (4.81)$$

This has a double pole at  $\varepsilon = 0$ .

Since the initial Lagrangian has been modified by the additional term  $\mathcal{L}_{\text{c.t.}}$  which generates the counterterms necessary to subtract the divergent pole terms for one loop Feynman integrals we must also consider Feynman graphs involving vertices generated by this. With  $g = 0$  at this order we need consider only

$$\frac{1}{2}B\phi^2 + \frac{1}{24}D\phi^4.\quad (4.82)$$

For one loop graphs with two external lines and to first order in  $B, D$  we have

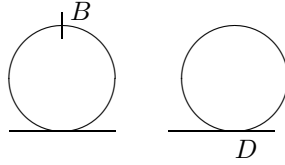

The corresponding integrals are

$$\hat{\tau}_2^{(1)}(p, -p)_{\text{c.t.}} = \frac{1}{2}B^{(1)}\lambda \int \frac{d^d k}{(2\pi)^d} \frac{1}{(k^2 + m^2)^2} - \frac{1}{2}D^{(1)} \int \frac{d^d k}{(2\pi)^d} \frac{1}{k^2 + m^2}.\quad (4.83)$$

Let us write  $D^{(1)} = \frac{1}{3}D^{(1)} + \frac{2}{3}D^{(1)}$  and for the moment keep only the  $\frac{1}{3}D^{(1)}$  term (the remaining  $\frac{2}{3}D^{(1)}$  will contribute elsewhere). The one-loop contributions from these counterterms, with the previously calculated results for  $B^{(1)}, D^{(1)}$ , are then

$$\begin{aligned}\hat{\tau}_2^{(1)}(p, -p)_{\text{c.t.,a}} &= \frac{1}{2} \frac{\lambda m^2}{16\pi^2\varepsilon} \lambda \int \frac{d^d k}{(2\pi)^d} \frac{1}{(k^2 + m^2)^2} - \frac{1}{2} \frac{\lambda^2}{16\pi^2\varepsilon} \int \frac{d^d k}{(2\pi)^d} \frac{1}{k^2 + m^2} \\ &= \frac{1}{2} \frac{\lambda^2 m^2}{16\pi^2\varepsilon} \frac{(m^2)^{-\frac{\varepsilon}{2}}}{(4\pi)^{\frac{d}{2}}} \Gamma\left(2 - \frac{d}{2}\right) \left(1 - \frac{1}{1 - \frac{d}{2}}\right) \\ &\sim \frac{\lambda^2 m^2}{(4\pi)^4} \left(\frac{2}{\varepsilon^2} + \frac{1}{2\varepsilon} - \frac{1}{\varepsilon}\log m^2\right)[e^{-\gamma}4\pi]^{\frac{1}{2}\varepsilon}.\end{aligned}\quad (4.84)$$

Taking everything together we get

$$\hat{\tau}_2^{(2)}(p, -p)_a + \hat{\tau}_2^{(1)}(p, -p)_{\text{c.t.,a}} \sim \frac{\lambda^2 m^2}{(4\pi)^4} \frac{1}{\varepsilon^2} + \text{finite terms}.\quad (4.85)$$

In this result there are no  $\frac{1}{\varepsilon}\log m^2$  terms - the residue is polynomial in  $\lambda$  and  $m^2$ .

The calculation for the second graph is more complicated, so we will only sketch this:

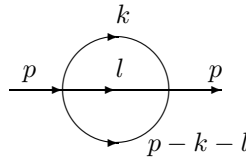

The corresponding Feynman integral is

$$\hat{\tau}_2^{(2)}(p, -p)_b = \frac{1}{6}\lambda^2 \int \frac{d^d k}{(2\pi)^d} \frac{d^d l}{(2\pi)^d} \frac{1}{(k^2 + m^2)(l^2 + m^2)((p-k-l)^2 + m^2)}.\quad (4.86)$$

There are sub-divergences as  $k \rightarrow \infty$  for finite  $l$ , as  $l \rightarrow \infty$  for finite  $k$  and as  $k \rightarrow \infty$  for finite  $k + l$ .

There are various ways in which we can treat this integral; to work this out in full is pretty complicated. First consider the  $l$  integral:

$$\int \frac{d^d l}{(2\pi)^d} \frac{1}{(l^2 + m^2)((p' - l)^2 + m^2)} = \frac{\Gamma(2 - \frac{d}{2})}{(4\pi)^{\frac{d}{2}}} \int_0^1 d\alpha (\alpha(1 - \alpha)p'^2 + m^2)^{\frac{d}{2} - 2}, \quad p' = p - k. \quad (4.87)$$

If this is then inserted into the  $k$ -integral the result is a bit messy. We therefore consider the special case  $m^2 = 0$ , which allows the integrals to be done completely. Then

$$\int \frac{d^d l}{(2\pi)^d} \frac{1}{l^2(p' - l)^2} = \frac{\Gamma(2 - \frac{d}{2})}{(4\pi)^{\frac{d}{2}}} K_d (p'^2)^{\frac{d}{2} - 2}, \quad K_d = \int_0^1 d\alpha (\alpha(1 - \alpha))^{\frac{d}{2} - 2}. \quad (4.88)$$

Now substitute this into the initial integral to get

$$\hat{\tau}_2^{(2)}(p, -p)_b|_{m^2=0} = \frac{1}{6} \lambda^2 \frac{\Gamma(2 - \frac{d}{2})}{(4\pi)^{\frac{d}{2}}} K_d \int \frac{d^d k}{(2\pi)^d} \frac{1}{k^2} ((k - p)^2)^{\frac{d}{2} - 2}. \quad (4.89)$$

To rewrite this we may use the standard representations

$$\frac{1}{k^2} = \int_0^\infty d\beta_2 e^{-\beta_2 k^2}; \quad \Gamma(2 - \frac{d}{2}) ((k - p)^2)^{\frac{d}{2} - 2} = \int_0^\infty d\beta_1 \beta_1^{1 - \frac{d}{2}} e^{-\beta_1 (p - k)^2}, \quad (4.90)$$

and then this implies

$$\hat{\tau}_2^{(2)}(p, -p)_b|_{m^2=0} = \frac{1}{6} \lambda^2 \frac{1}{(4\pi)^{\frac{d}{2}}} K_d \int_0^\infty d\beta_1 \int_0^\infty d\beta_2 \int \frac{d^d k}{(2\pi)^d} e^{-\beta_2 k^2} \beta_1^{1 - \frac{d}{2}} e^{-\beta_1 (p - k)^2}, \quad (4.91)$$

so that we can complete the square

$$\beta_2 k^2 + \beta_1 (p - k)^2 = (\beta_1 + \beta_2) k'^2 + \frac{\beta_1 \beta_2}{\beta_1 + \beta_2} p^2, \quad k' = k - \frac{\beta_1}{\beta_1 + \beta_2} p. \quad (4.92)$$

It is now easy to carry out the  $k'$ -integration:

$$\hat{\tau}_2^{(2)}(p, -p)_b|_{m^2=0} = \frac{1}{6} \frac{\lambda^2}{(4\pi)^d} K_d \int_0^\infty d\beta_1 \int_0^\infty d\beta_2 \frac{\beta_1^{1 - \frac{d}{2}}}{(\beta_1 + \beta_2)^{\frac{d}{2}}} e^{-\frac{\beta_1 \beta_2}{\beta_1 + \beta_2} p^2}. \quad (4.93)$$

Now substitute  $\beta_1 + \beta_2 = s$ ,  $\beta_1 = s\beta$ ,  $\beta_2 = (1 - s)\beta$  to obtain

$$\begin{aligned} \hat{\tau}_2^{(2)}(p, -p)_b|_{m^2=0} &= \frac{1}{6} \frac{\lambda^2}{(4\pi)^d} K_d \int_0^1 d\beta \beta^{1 - \frac{d}{2}} \int_0^\infty ds s^{2-d} e^{-s\beta(1-\beta)p^2} \\ &= \frac{1}{6} \frac{\lambda^2}{(4\pi)^d} K_d \Gamma(3 - d) (p^2)^{d-3} \int_0^1 d\beta \beta^{\frac{d}{2} - 2} (1 - \beta)^{d-3} \\ &\sim -\frac{1}{12} \frac{\lambda^2}{(16\pi^2)^2 \varepsilon} p^2, \end{aligned} \quad (4.94)$$

noting that, with  $d = 4 - \varepsilon$ ,  $\Gamma(3 - d) \sim -\frac{1}{\varepsilon}$ ,  $K_4 = 1$ . This can be cancelled with a contribution

$$A^{(2)} = -\frac{1}{12} \frac{\lambda^2}{(16\pi^2)^2 \varepsilon}. \quad (4.95)$$

Another special case which is tractable is to consider  $m^2 \neq 0$ , but  $p^2 = 0$ . Following the same approach as before

$$\hat{\tau}_2^{(2)}(0,0)_b = \frac{1}{6} \lambda^2 \frac{\Gamma(2 - \frac{d}{2})}{(4\pi)^{\frac{d}{2}}} \int \frac{d^d k}{(2\pi)^d} \frac{1}{k^2 + m^2} \int_0^1 d\alpha (\alpha(1 - \alpha)k^2 + m^2)^{\frac{d}{2} - 2}. \quad (4.96)$$

Writing both factors as exponentials, with integrals over  $\beta_1, \beta_2$ , allows the  $k$ -integration to be carried out. The  $\beta_1, \beta_2$  integrations can be treated in the same fashion as previously giving

$$\hat{\tau}_2^{(2)}(0,0)_b = \frac{1}{6} \lambda^2 (m^2)^{d-3} \frac{1}{(4\pi)^d} \Gamma(3 - d) J_2, \quad (4.97)$$

for

$$J_2 = \int_0^1 d\alpha \int_0^1 d\beta \beta^{1 - \frac{d}{2}} (1 - \beta + \beta\alpha(1 - \alpha))^{-\frac{d}{2}}. \quad (4.98)$$

At this point the integral is no longer in the domain of opening theory, if this were ches, for evaluating Feynman integrals but it can be carried out in terms of hypergeometric functions. What is required here however is just to determine the poles in  $\varepsilon$  as  $\varepsilon \rightarrow 0$ . There is a pole due to the  $\Gamma(3 - d)$  factor but there are also poles coming from  $J_2$ . It is not difficult to see that there is a pole arising from the divergence of the  $\beta$ -integration as  $\beta \rightarrow 0$  but there are also poles from divergences at  $\beta \sim 1$  and  $\alpha \sim 0, 1$ . These correspond to the sub-divergencies present in the original Feynman integral. To disentangle these it is convenient to introduce into the integral expression for  $J_2$

$$1 = (1 - \beta) + \beta\alpha + \beta(1 - \alpha). \quad (4.99)$$

Each of the three terms which arise are identical. This reflects the symmetry of the original graph under permutation of lines but can also be demonstrated by considering a change of variables  $\beta' = \beta\alpha + 1 - \beta, \beta'\alpha' = \beta\alpha$  so that  $\beta(1 - \beta + \beta\alpha(1 - \alpha)) = \beta'(1 - \beta' + \beta'\alpha'(1 - \alpha'))$  and  $\beta d\beta d\alpha = \beta' d\beta' d\alpha'$ . Hence we can write

$$J_2 = 3 \int_0^1 d\alpha \int_0^1 d\beta \beta^{1 - \frac{d}{2}} (1 - \beta) (1 - \beta + \beta\alpha(1 - \alpha))^{-\frac{d}{2}}. \quad (4.100)$$

This expression now has a divergence only when  $\beta \sim 0$  so that  $J_2$  can be decomposed

$$\begin{aligned} J_2 &= 3 \int_0^1 d\alpha \int_0^1 d\beta \beta^{1 - \frac{d}{2}} + J_2' = 3 \frac{2}{\varepsilon} + J_2', \\ J_2' &= 3 \int_0^1 d\alpha \int_0^1 d\beta \beta^{1 - \frac{d}{2}} \left( (1 - \beta) (1 - \beta + \beta\alpha(1 - \alpha))^{-\frac{d}{2}} - 1 \right), \end{aligned} \quad (4.101)$$

where  $J_2'$  is finite for  $d = 4$  since there is no divergence at  $\beta = 0$ . Hence letting  $\beta \rightarrow 1/\beta$

$$\begin{aligned} J_2'|_{d=4} &= 3 \int_0^1 d\alpha \int_1^\infty d\beta \left( \frac{\beta - 1}{(\beta - 1 + \alpha(1 - \alpha))^2} - \frac{1}{\beta} \right) \\ &= 3 \int_0^1 d\alpha (-\log \alpha(1 - \alpha) - 1) = 3. \end{aligned} \quad (4.102)$$

The expression for  $J_2$  then becomes

$$J_2 = 3 \left( \frac{2}{\varepsilon} + 1 \right) + \mathcal{O}(\varepsilon). \quad (4.103)$$

With this result for  $J_2$  and applying (4.49) for  $\Gamma(3 - d) = \Gamma(\varepsilon - 1)$  we then have in (4.97)

$$\hat{\tau}_2^{(2)}(0,0)_b = -\frac{1}{2} \frac{\lambda^2 m^2}{(16\pi^2)^2} \left( \frac{2}{\varepsilon^2} + \frac{3}{\varepsilon} - \frac{2}{\varepsilon} \log m^2 \right) [e^{-\gamma} 4\pi]^\varepsilon + \text{finite parts}. \quad (4.104)$$

There is also additional corresponding contribution comes from the the counterterms where we consider the contribution from  $\frac{2}{3}D^{(1)}$  (since we took account of the  $\frac{1}{3}D^{(1)}$  part previously)

which is given by

$$\begin{aligned}\hat{\tau}_2^{(2)}(0,0)_{\text{c.t.},b} &= -\frac{1}{2} \frac{2\lambda^2}{16\pi^2\varepsilon} \int \frac{d^d k}{(2\pi)^d} \frac{1}{k^2 + m^2} = -\frac{1}{2} \frac{2\lambda^2}{16\pi^2\varepsilon} \frac{1}{(4\pi)^{\frac{d}{2}}} \Gamma\left(1 - \frac{d}{2}\right) (m^2)^{\frac{d}{2}-1} \\ &\sim \frac{\lambda^2}{(16\pi^2)^2} m^2 \left(\frac{2}{\varepsilon^2} + \frac{1}{\varepsilon} - \frac{1}{\varepsilon} \log m^2\right) [e^{-\gamma} 4\pi]^{\frac{1}{2}\varepsilon} + \text{finite parts},\end{aligned}\quad (4.105)$$

where the integral was evaluated before. Adding this to  $\hat{\tau}_2^{(2)}(0,0)_b$  gives

$$\hat{\tau}_2^{(2)}(0,0)_b + \hat{\tau}_2^{(2)}(0,0)_{\text{c.t.},b} \sim \frac{\lambda^2 m^2}{(16\pi^2)^2} \left(\frac{1}{\varepsilon^2} - \frac{1}{2\varepsilon}\right), \quad (4.106)$$

and again there is no  $\log m^2$  term left.

If we combine both two loop graphs by adding the results in (4.85), (4.94) and (4.106) the two loop divergent part becomes

$$\hat{\tau}_2^{(2)}(p,-p) + \hat{\tau}_2^{(2)}(p,-p)_{\text{c.t.}} \sim -\frac{1}{12} \frac{\lambda^2}{(16\pi^2)^2\varepsilon} p^2 + \frac{\lambda^2 m^2}{(16\pi^2)^2} \left(\frac{2}{\varepsilon^2} - \frac{1}{2\varepsilon}\right). \quad (4.107)$$

This is the general result as contributions to the Feynman integrals which have been neglected are all finite when  $d = 4$ . Hence the divergences which are present in  $\hat{\tau}_2^{(2)}(p,-p)$ , after subtracting sub-divergencies as shown above, can now be cancelled by additional contributions to  $A$  and  $B$ , which give a contribution to  $\hat{\tau}_2$  of the form  $-Ap^2 - B$ . The two loop results, ensuring that  $\hat{\tau}_2^{(2)}$  is finite, are then determined to be

$$\boxed{A^{(2)} = -\frac{1}{12} \frac{\lambda^2}{(16\pi^2)^2\varepsilon}, \quad B^{(2)} = \frac{\lambda^2 m^2}{(16\pi^2)^2} \left(\frac{2}{\varepsilon^2} - \frac{1}{2\varepsilon}\right)}, \quad (4.108)$$

which involve both double and single poles in  $\varepsilon$ .

### 4.3 Renormalisation and the Renormalisation Group

The results of one and two loop calculations can be generalised to the crucial result for perturbative quantum field theory:

#### Renormalisation Theorem

*If all sub-divergences in a FEYNMAN integral are subtracted, then depending on the degree of divergence  $D$ ,*

- (i) *if  $D < 0$ , then the integral is finite,*
- (ii) *if  $D \geq 0$ , then the divergent part (i.e. the poles in  $\varepsilon$ ) is proportional to a polynomial in the external momenta and the couplings of dimension  $D$ .*
- (iii) *the divergences are cancelled by appropriate counterterms which determine  $\mathcal{L}_{\text{c.t.}}$ , these counterterms then generate additional Feynman graphs whose corresponding Feynman integrals then cancel sub-divergences in higher loop integrals.*

For the  $\phi^4$  theory then  $\hat{\tau}_4$  has  $D = 0$  and the divergent part is a dimensionless constant depending only on the coupling  $\lambda$  while  $\hat{\tau}_2$  has  $D = 2$  and the divergent part is linear in  $m^2$  and  $p^2$  with coefficients depending on  $\lambda$ . For a general potential  $V(\phi)$  which is a polynomial of degree four,

$$D \leq 4 - E. \quad (4.109)$$

We then only need counterterms of degree four in  $\phi$ . So we may restrict  $\mathcal{L}_{\text{c.t.}}$  to the form specified by  $A$  and  $V_{\text{c.t.}}(\phi)$ . In fact, we can write

$$A = \sum_{n \geq 1} \frac{a_n(\lambda)}{\varepsilon^n}, \quad V_{\text{c.t.}}(\phi) = \sum_{n \geq 1} \frac{1}{\varepsilon^n} V_n(\phi). \quad (4.110)$$

$V_n(\phi)$  is a polynomial which depends on  $V''(\phi)$ ,  $V'''(\phi)$  and  $\lambda$ , and is of degree four in  $\phi$ , e.g. at one loop

$$A^{(1)} = 0, \quad V_{\text{c.t.}}^{(1)}(\phi) = \frac{1}{32\pi^2\varepsilon} V''(\phi)^2. \quad (4.111)$$

The basic theorem is true for any quantum field theory. However, for non-renormalisable theories,  $D$  increases with the number of loops and is not restricted by the number of external lines. In this situation, the counterterm  $\mathcal{L}_{\text{c.t.}}$  becomes arbitrarily complex with many parameters as the order of the calculation increases. For renormalisable theories,  $D$  is bounded;  $\mathcal{L}_{\text{c.t.}}$  may be restricted to the same form as the original LAGRANGIAN.

Ultimately the theorem demonstrates that the limit

$$Z[J]_{\text{ren.}} = \lim_{\varepsilon \rightarrow 0} \int d[\phi] e^{i(S[\phi] + S_{\text{c.t.}}[\phi]) + i \int d^d x J(x)\phi(x)}, \quad (4.112)$$

exists to any order of perturbation theory so long as  $S_{\text{c.t.}}$  is chosen suitably. As a consequence we have finite renormalised connected 1PI functions  $\hat{\tau}_n(p_1, \dots, p_n)_{\text{ren.}}$ .

### 4.3.1 Bare LAGRANGIANS

Let us now restrict our attention to scalar  $\phi^4$  theory. We know on the basis of the renormalisation theorem, as described above, that adding

$$\mathcal{L}_{\text{c.t.}} = -A \frac{1}{2} \partial^\mu \phi \partial_\mu \phi - V_{\text{c.t.}}(\phi) \quad (4.113)$$

to the initial Lagrangian  $\mathcal{L}$  is sufficient to all orders of perturbation theory, for suitable  $A$  and  $V_{\text{c.t.}}(\phi)$  which is itself a polynomial of degree four, to ensure that the resulting theory determines finite correlation functions of arbitrary numbers of scalar fields  $\langle \phi(x_1) \dots \phi(x_n) \rangle$ . Let us define a bare Lagrangian by

$$\mathcal{L}_0 = \mathcal{L} + \mathcal{L}_{\text{c.t.}} = -Z \frac{1}{2} \partial^\mu \phi \partial_\mu \phi - V(\phi) - V_{\text{c.t.}}(\phi), \quad (4.114)$$

where

$$Z = 1 + A. \quad (4.115)$$

This can be simplified by a rescaling of  $\phi$  to ensure the coefficient of the kinetic term is the same as in the initial theory, thus

$$\phi_0 = \sqrt{Z} \phi, \quad (4.116)$$

and hence then

$$\mathcal{L}_0 = -\frac{1}{2} \partial^\mu \phi_0 \partial_\mu \phi_0 - V_0(\phi_0). \quad (4.117)$$

Since  $A$  is given by a formal power series in  $\lambda$  then  $\sqrt{Z}$  may also be defined as a power series in  $\lambda$  without ambiguity. It is essential that  $Z > 0$  but this is never an issue in perturbation theory. We also call  $\phi_0$  the bare field and  $V_0(\phi_0)$  the bare potential which is again a quartic polynomial.

Now suppose that  $g = 0$ , so that

$$V_{\text{c.t.}}(\phi) = \frac{1}{2} B \phi^2 + \frac{1}{24} D \phi^4; \quad V_0(\phi_0) = \frac{1}{2} m_0^2 \phi_0^2 + \frac{1}{24} \lambda_0 \phi_0^4, \quad (4.118)$$

where

$$\lambda_0 = \frac{\lambda + D}{Z^2}, \quad m_0^2 = \frac{m^2 + B}{Z}. \quad (4.119)$$

From the one-loop results obtained so far

$$m_0^2 = m^2 \left( 1 + \frac{\lambda}{16\pi^2 \varepsilon} \right), \quad \lambda_0 = \lambda \left( 1 + \frac{3\lambda}{16\pi^2 \varepsilon} \right), \quad Z = 1 + O(\lambda^2). \quad (4.120)$$

The so-called bare quantities  $m_0^2$  and  $\lambda_0$  are expressible in terms of the original parameters as a power series in  $\lambda$  with more and more divergent terms or higher and higher poles in  $\varepsilon$ .

The functional integral may be rewritten in terms of  $\phi_0$  and  $\mathcal{L}_0$ :

$$S_0[\phi_0] = \int d^d x \mathcal{L}_0(\phi_0), \quad d[\phi] = N d[\phi_0], \quad (4.121)$$

where  $N$  is some constant, so that

$$\langle F(\phi_0) \rangle = \frac{1}{Z_0} \int d[\phi_0] e^{iS_0[\phi_0]} F(\phi_0), \quad (4.122)$$

with  $Z_0$  chosen so that  $\langle 1 \rangle = 1$ .

However, we avoided one slight subtlety which we now have to take into account, related with a dimensional analysis; in the process of regularisation it is necessary to introduce a mass scale. A cut-off  $\Lambda$  introduces an obvious mass scale. In dimensional regularisation however it has not been perhaps apparent, and is slightly more subtle. We extended  $\mathcal{L}$  to  $d \neq 4$ . This is something one should worry about, because dimensions change as you change dimension. Since an action has dimension zero,  $\mathcal{L}$  must have dimension  $d$ , so that  $V(\phi)$  also has dimension  $d$ , whereas  $\phi$  has dimension  $\frac{1}{2}d - 1$ . These are ordinary, everyday dimensions. For a potential

$$V(\phi) = \frac{1}{2}m^2\phi^2 + \frac{1}{6}g\phi^3 + \frac{1}{24}\lambda\phi^4, \quad (4.123)$$

this means that  $m^2$  has dimension 2 as usual while  $g$  has dimension  $3 - \frac{1}{2}d$  and  $\lambda$  has dimension  $4 - d$ . In the end the dimension should be four and the physical couplings  $g$  and  $\lambda$ , which parameterise the theory, should have dimension 1 and 0, as they would in other regularisation schemes. This can be achieved by replacing in  $V(\phi)$  in dimensions  $d \neq 4$

$$g \rightarrow g\mu^{\frac{\varepsilon}{2}}, \quad \lambda \rightarrow \lambda\mu^\varepsilon, \quad (4.124)$$

where  $\mu$  defines an (arbitrary) mass scale. Hence with  $d = 4 - \varepsilon$  we now write the potential term as

$$V(\phi) = \frac{1}{2}m^2\phi^2 + \frac{1}{6}g\mu^{\frac{\varepsilon}{2}}\phi^3 + \frac{1}{24}\lambda\mu^\varepsilon\phi^4. \quad (4.125)$$

Correspondingly in the counterterm potential we let  $D \rightarrow \mu^\varepsilon D$  and  $C \rightarrow \mu^{\frac{1}{2}\varepsilon} C$ .

### 4.3.2 The CALLAN-SYMANZIK Equation

For simplicity we consider the case  $g = 0$  when the bare LAGRANGIAN is

$$\mathcal{L}_0 = -\frac{1}{2}\partial^\mu\phi_0\partial_\mu\phi_0 - \frac{1}{2}m_0^2\phi_0^2 - \frac{1}{24}\lambda_0\phi_0^4. \quad (4.126)$$

This depends on  $m_0^2$ ,  $\lambda_0$  and  $\phi_0$  and clearly  $\mathcal{L}_0$  is then independent of  $\mu$ .

The bare quantities are functions of the finite  $\lambda, m^2$ . With the prescription that the counterterms necessary to ensure finiteness involve contributions which are just poles in  $\varepsilon$  we have relation of the form

$$\mu^{-\varepsilon}\lambda_0 = \lambda + F_\lambda(\lambda, \varepsilon), \quad F_\lambda(\lambda, \varepsilon) = \sum_{n=1}^{\infty} \frac{f_n(\lambda)}{\varepsilon^n}, \quad (4.127)$$

and also

$$m_0^2 = m^2(1 + F_{m^2}(\lambda, \varepsilon)), \quad F_{m^2}(\lambda, \varepsilon) = \sum_{n=1}^{\infty} \frac{b_n(\lambda)}{\varepsilon^n}. \quad (4.128)$$

Similarly, we can write that

$$Z = 1 + \sum_{n \geq 1} \frac{a_n(\lambda)}{\varepsilon^n}. \quad (4.129)$$

The finite physical correlation functions depend then on  $\lambda, m^2$  and also  $\mu$  which appears to be more than the bare theory. In fact  $\mu$  is arbitrary but to show this more precisely it is necessary to consider the relation between the bare theory results, which are independent of  $\mu$ , and the corresponding finite quantities obtained by the regularisation procedure. Correlation functions for the bare fields may be defined formally by a functional integral,

$$G_n^0(x; \lambda_0, m_0^2) := \langle \phi_0(x_1) \dots \phi_0(x_n) \rangle = \frac{1}{\int d[\phi_0] e^{iS_0[\phi_0]}} \int d[\phi_0] \phi_0(x_1) \dots \phi_0(x_n) e^{iS_0[\phi_0]}, \quad (4.130)$$

where  $x = (x_1, \dots, x_n)$  and the result depends on the bare parameters  $\lambda_0$  and  $m_0^2$ . Since  $\phi_0 = \sqrt{Z}\phi$

$$G_n(x; \lambda, m^2, \mu) := \langle \phi(x_1) \dots \phi(x_n) \rangle = Z^{-\frac{n}{2}} G_n^0(x; \lambda_0, m_0^2), \quad (4.131)$$

and crucially  $G_n(x; \lambda, m^2, \mu)$  is a finite function of  $\lambda, m^2$ , with a non singular limit as  $\varepsilon \rightarrow 0$ . The critical observation is that this also depends on  $\mu$  since this is a necessary part of the regularisation procedure. Because bare quantities do not depend on the mass scale  $\mu$ , it is clear that

$$\mu \frac{d}{d\mu} G_n^0(x; \lambda_0, m_0^2) = 0, \quad (4.132)$$

and it follows that

$$\mu \frac{d}{d\mu} (Z^{\frac{n}{2}} G_n(x; \lambda, m^2, \mu)) \Big|_{\lambda_0, m_0^2} = 0. \quad (4.133)$$

By using the standard chain rule this becomes a linear first order partial differential equation. First define

$$\hat{\beta}_\lambda := \mu \frac{d\lambda}{d\mu} \Big|_{\lambda_0}, \quad \beta_{m^2} := \mu \frac{d}{d\mu} m^2 \Big|_{m_0^2, \lambda_0}, \quad \gamma_\phi \sqrt{Z} := \mu \frac{d}{d\mu} \sqrt{Z} \Big|_{\lambda_0}. \quad (4.134)$$

Then we obtain

$$\boxed{\left( \mu \frac{\partial}{\partial \mu} + \hat{\beta}_\lambda \frac{\partial}{\partial \lambda} + \beta_{m^2} \frac{\partial}{\partial m^2} + n\gamma_\phi \right) G_n(x; \lambda, m^2, \mu) = 0.} \quad (4.135)$$

This equation will play an important role; it is called the CALLAN-SYMANZIK<sup>36</sup> or *renormalisation group (RG) equation*. Since  $G_n$  is finite, i.e. there are no poles in  $\varepsilon$ , the quantities  $\hat{\beta}_\lambda$ ,  $\beta_{m^2}$  and  $\gamma_\phi$  must also be finite and have no poles in  $\varepsilon$ . The RG equation follows from perturbation theory and essentially the renormalisation theorem stated above. Similar equations are valid for any renormalisable quantum field theory and are assumed to be an exact property.

Let us illustrate how we can determine the functions appearing in the RG equation. By considering the relation between  $\lambda_0$  and  $\lambda$  we have

$$\begin{aligned} \mu \frac{d}{d\mu} (\mu^{-\varepsilon} \lambda_0) \Big|_{\lambda_0} &= -\varepsilon \mu^{-\varepsilon} \lambda_0 = -\varepsilon (\lambda + F_\lambda) \\ &= \mu \frac{d}{d\mu} (\lambda + F(\lambda, \varepsilon)) \Big|_{\lambda_0} = \hat{\beta}_\lambda \frac{\partial}{\partial \lambda} (\lambda + F(\lambda, \varepsilon)) = \hat{\beta}_\lambda + \hat{\beta}_\lambda \frac{\partial}{\partial \lambda} F_\lambda. \end{aligned} \quad (4.136)$$

If we define  $\beta_\lambda$  by

$$\hat{\beta}_\lambda = -\varepsilon \lambda + \beta_\lambda, \quad (4.137)$$

then this can be re-expressed as

$$\beta_\lambda = -\varepsilon F_\lambda - (-\varepsilon \lambda + \beta_\lambda) \frac{\partial}{\partial \lambda} F_\lambda = \varepsilon \left( \lambda \frac{\partial}{\partial \lambda} - 1 \right) F_\lambda - \beta_\lambda \frac{\partial}{\partial \lambda} F_\lambda. \quad (4.138)$$

Now since  $F_\lambda$  is given by an expansion in  $\varepsilon^{-n}$ , for  $n = 1, 2, \dots$ , and since  $\beta_\lambda$  has no poles in  $\varepsilon$  the equation is only consistent if

$$\boxed{\beta_\lambda(\lambda) = \left( \lambda \frac{\partial}{\partial \lambda} - 1 \right) f_1(\lambda),} \quad (4.139)$$

and in fact  $\beta_\lambda$  is then independent of  $\varepsilon$ . Furthermore the pole terms,  $\varepsilon^{-n}$  with  $n > 0$ , on the right hand side must cancel which gives

$$\left( \lambda \frac{\partial}{\partial \lambda} - 1 \right) f_{n+1}(\lambda) = \beta_\lambda(\lambda) \frac{\partial}{\partial \lambda} f_n(\lambda). \quad (4.140)$$

This recursive relation enables us to calculate  $f_n(\lambda)$  ultimately in terms of  $f_1(\lambda)$  and  $\beta_\lambda(\lambda)$  which is also determined by  $f_1(\lambda)$ .

<sup>36</sup>Callan, Curtis (1942-); Symanzik, Kurt (1923-1983)

We can obtain similar results from the relation between  $m_0^2$  and  $m^2, \lambda$ . Taking derivatives with respect to  $\mu$ :

$$\begin{aligned} 0 &= \mu \frac{d}{d\mu} m_0^2 \Big|_{m_0^2, \lambda_0} = \mu \frac{d}{d\mu} (m^2(1 + F_{m^2})) \Big|_{m_0^2, \lambda_0} \\ &= \left( \hat{\beta}_\lambda \frac{\partial}{\partial \lambda} + \beta_{m^2} \frac{\partial}{\partial m^2} \right) (m^2(1 + F_{m^2})) = \beta_{m^2} (1 + F_{m^2}) + m^2 \hat{\beta}_\lambda \frac{\partial}{\partial \lambda} F_{m^2}. \end{aligned} \quad (4.141)$$

Defining a new function  $\gamma_{m^2}(\lambda)$  by

$$\beta_{m^2} = m^2 \gamma_{m^2}(\lambda), \quad (4.142)$$

this gives

$$\gamma_{m^2} = -(-\varepsilon\lambda + \beta_\lambda) \frac{\partial}{\partial \lambda} F_{m^2} - \gamma_{m^2} F_{m^2}. \quad (4.143)$$

By the same argument as before,  $\gamma_{m^2}$  is finite and so has to be independent of  $\varepsilon$ . It is determined just by the simple poles in  $F_{m^2}$

$$\boxed{\gamma_{m^2}(\lambda) = \lambda \frac{\partial}{\partial \lambda} b_1(\lambda)}, \quad (4.144)$$

and also the higher order poles are iteratively determined by

$$\lambda \frac{\partial}{\partial \lambda} b_{n+1}(\lambda) = \left( \gamma_{m^2}(\lambda) + \beta_\lambda(\lambda) \frac{\partial}{\partial \lambda} \right) b_n(\lambda). \quad (4.145)$$

The definition of  $\gamma_\phi$  may be rewritten

$$Z\gamma_\phi = \frac{1}{2} \mu \frac{d}{d\mu} Z \Big|_{\lambda_0}. \quad (4.146)$$

Inserting  $Z = 1 + A$ , this gives

$$(1 + A)\gamma_\phi = \frac{1}{2} \mu \frac{d}{d\mu} A \Big|_{\lambda_0} = \frac{1}{2} \hat{\beta}_\lambda \frac{\partial}{\partial \lambda} A, \quad (4.147)$$

which implies

$$\gamma_\phi = \frac{1}{2} (-\varepsilon\lambda + \beta_\lambda) \frac{\partial}{\partial \lambda} A - \gamma_\phi A. \quad (4.148)$$

Looking at the  $O(\varepsilon^0)$  coefficients gives

$$\boxed{\gamma_\phi(\lambda) = -\frac{1}{2} \lambda \frac{\partial}{\partial \lambda} a_1(\lambda)}, \quad (4.149)$$

and also to  $O(\varepsilon^{-n})$

$$\lambda \frac{\partial}{\partial \lambda} a_{n+1}(\lambda) = \left( \beta_\lambda(\lambda) \frac{\partial}{\partial \lambda} - 2\gamma_\phi(\lambda) \right) a_n(\lambda). \quad (4.150)$$

Let us consider what happens for one loop for this scalar theory. The results that we previously derived were

$$\mu^{-\varepsilon} \lambda_0 = \lambda + \frac{3\lambda^2}{16\pi^2\varepsilon} + O(\lambda^3), \quad (4.151a)$$

$$m_0^2 = m^2 \left( 1 + \frac{\lambda}{16\pi^2\varepsilon} + O(\lambda^2) \right), \quad (4.151b)$$

which gives to lowest order

$$\beta_\lambda(\lambda) = \frac{3\lambda^2}{16\pi^2} + O(\lambda^3), \quad (4.152a)$$

$$\gamma_{m^2}(\lambda) = \frac{\lambda}{16\pi^2} + O(\lambda^2), \quad (4.152b)$$

and we also have  $\gamma_\phi(\lambda) = O(\lambda^2)$ .



### 4.3.3 Evolution of Coupling Constants

We consider here solving the CALLAN-SYMANZIK equation but since this may be derived in any renormalisable theory we consider this in general without restriction to any particular theory. For simplicity we consider a single dimensionless coupling  $g$  with a corresponding  $\beta$ -function  $\beta(g)$ . If we set any mass  $m = 0$  the equation has the generic form

$$\left( \mu \frac{\partial}{\partial \mu} + \beta(g) \frac{\partial}{\partial g} + \gamma(g) \right) G(\{p\}; g, \mu) = 0, \quad (4.153)$$

for  $G(\{p\}; g, \mu)$  a physical function of a set momenta  $\{p\}$  and also of the coupling  $g$  as well as the regularisation scale  $\mu$ .

If  $G$  is dimensionless, it can only depend on the quotient  $\frac{p}{\mu}$  for all momenta:

$$G(\{p\}; g, \mu) = F\left(\left\{\frac{p}{\mu}\right\}; g\right), \quad (4.154)$$

for some function  $F$ . Thus we can regard  $G$  as only a function of  $g$  and  $\mu$ . It is always possible to ensure that  $G$  is dimensionless by factoring out suitable momenta. The crucial point is then that the dependence on  $p$ , which is physically interesting, is related to the dependence on the arbitrary mass scale  $\mu$ . For the moment we drop  $\gamma$  and be restored later. The basic equation is then simply

$$\left( \mu \frac{\partial}{\partial \mu} + \beta(g) \frac{\partial}{\partial g} \right) G(g, \mu) = 0, \quad (4.155)$$

where the dependence on the momenta is left implicit. There exists a standard procedure, the method of characteristics, to solve this; define a quantity  $g(\mu)$  (which is called the *running coupling*) by the requirement that it is a solution of

$$\mu \frac{d}{d\mu} g = \beta(g). \quad (4.156)$$

This equation can be solved by

$$\int_{g(\mu_0)}^{g(\mu)} \frac{dg}{\beta(g)} = \log \frac{\mu}{\mu_0}. \quad (4.157)$$

Then the partial differential equation is reduced to

$$\mu \frac{d}{d\mu} G(g(\mu), \mu) = 0, \quad (4.158)$$

which requires that  $G(g(\mu), \mu)$  is independent of  $\mu$  or

$$\boxed{G(g(\mu), \mu) = G(g(\mu_0), \mu_0)}. \quad (4.159)$$

This is a reflection of the arbitrariness of  $\mu$ , the direct dependence on  $\mu$  is compensated by the dependence on  $g(\mu)$ , so that  $\mu, g$  are replaced by a single parameter.

If there is only one momentum, so that  $F = F\left(\frac{p^2}{\mu^2}; g\right)$ , the solution shows that

$$f\left(\frac{p^2}{\mu^2}; g(\mu)\right) = F\left(\frac{p^2}{\mu_0^2}; g(\mu_0)\right). \quad (4.160)$$

We may choose  $\mu_0 = p$  and then

$$f\left(\frac{p^2}{\mu^2}; g(\mu)\right) = F(1; g(p)), \quad (4.161)$$

so that the dependence on  $p$  is just given by  $g(p)$ . This allows us to make statements about the properties of the theory which follow from analysing how it depends on the coupling.

First we consider the qualitative features the solution for the running coupling  $g(\mu)$ . If  $\beta(g) > 0$  then  $g$  increases with  $\mu$ , whereas if  $\beta(g) < 0$  then  $g$  decreases with  $\mu$ . A graph for  $\beta(g)$  if  $\beta(g) > 0$  for small  $g$  and also if  $\beta(g_*) = 0$  for some finite  $g_*$  has the form

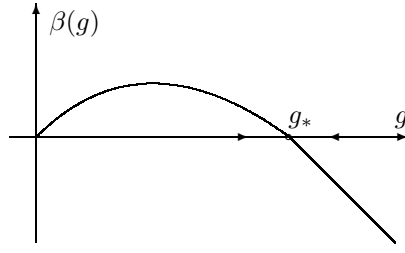

For such a functional dependence  $g(\mu) \rightarrow g_*$  as  $\mu \rightarrow \infty$ . We can say that  $g_*$  is an *ultraviolet (UV) fixed point*. If we assume  $\beta(g)$  is negative for small  $g$ , the picture looks like this:

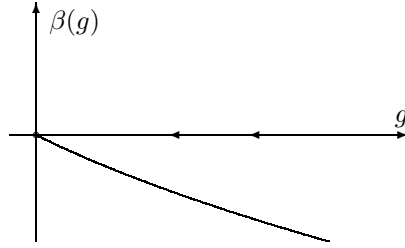

In this case  $g(\mu) \rightarrow 0$  as  $\mu \rightarrow \infty$ . (Note that always  $\beta(0) = 0$ .) In this case  $g = 0$  is an ultraviolet fixed point. This situation is referred to as *asymptotic freedom*.

Let us now bring  $\gamma$  back into the equation and see what modification of the solution is required. For

$$\left( \mu \frac{\partial}{\partial \mu} + \beta(g) \frac{\partial}{\partial g} + \gamma(g) \right) G(g, \mu) = 0, \quad (4.162)$$

we introduce  $g(\mu)$  as before and the equation becomes

$$\mu \frac{d}{d\mu} G(g(\mu), \mu) = -\gamma(g(\mu)) G(g(\mu), \mu). \quad (4.163)$$

This can be integrated to give

$$G(g(\mu), \mu) = e^{-\int_{\mu_0}^{\mu} \frac{ds}{s} \gamma(g(s))} G(g(\mu_0), \mu_0). \quad (4.164)$$

The exponent may also be rewritten by a change of integration variable as

$$\int_{\mu_0}^{\mu} \frac{ds}{s} \gamma(g(s)) = \int_{g(\mu_0)}^{g(\mu)} dg \frac{\gamma(g)}{\beta(g)}. \quad (4.165)$$

If there is a UV fixed point  $g_*$  then

$$\int_{\mu_0}^{\mu} \frac{ds}{s} \gamma(g(s)) \rightarrow \gamma(g_*) \cdot \log \mu \quad \text{as } \mu \rightarrow \infty. \quad (4.166)$$

For the function of a single momentum  $F$  these results give

$$f\left(\frac{p^2}{\mu^2}; g(\mu)\right) = e^{\int_{\mu}^p \frac{ds}{s} \gamma(g(s))} F(1; g(p)). \quad (4.167)$$

Asymptotically, when there is an ultraviolet fixed point, as  $p \rightarrow \infty$ ,

$$f\left(\frac{p^2}{\mu^2}; g(\mu)\right) \sim p^{\gamma(g_*)} F(1; g_*). \quad (4.168)$$

When  $g$  is small we may use perturbative results. As an example suppose

$$\beta(g) = -bg^3. \quad (4.169)$$

If  $b > 0$  there is asymptotic freedom and as  $g(\mu) \rightarrow 0$  for large  $\mu$  the small  $g$  perturbative results become a valid approximation. The running coupling is then given by the following integral,

$$-\frac{1}{b} \int_{g(\mu_0)}^{g(\mu)} \frac{dg}{g^3} = \log \frac{\mu}{\mu_0} \Rightarrow \frac{1}{g(\mu)^2} - \frac{1}{g(\mu_0)^2} = 2b \log \frac{\mu}{\mu_0}. \quad (4.170)$$

Now the right-hand side goes to infinity as  $\mu \rightarrow \infty$ , and so  $g(\mu)^2 \rightarrow 0$  if  $b > 0$ . We can rewrite this as

$$\boxed{\frac{1}{g(\mu)^2} = b \log \frac{\mu^2}{\Lambda^2}}, \quad (4.171)$$

for some constant  $\Lambda$ . Alternatively the constant  $\Lambda$ , which appears as a constant of integration, is given by

$$\Lambda = \mu e^{-\frac{1}{2bg(\mu)^2}}. \quad (4.172)$$

Let us suppose that  $\gamma(g) = cg^2$  as well; then the integral in the solution of the RG equation gives

$$\int_{g(\mu)}^{g(p)} dg \frac{\gamma(g)}{\beta(g)} = -\frac{c}{b} \log \frac{g(p)}{g(\mu)}. \quad (4.173)$$

The solution for  $F(p^2/\mu^2; g)$  becomes

$$f\left(\frac{p^2}{\mu^2}; g(\mu)\right) = \left(\frac{g^2(p)}{g^2(\mu)}\right)^{-\frac{c}{2b}} F(1; g(p)). \quad (4.174)$$

As  $p \rightarrow \infty$ ,  $g(p) \rightarrow 0$ , with asymptotic freedom, so that perturbative results for  $\beta(g)$ ,  $\gamma(g)$  and also  $F(p^2/\mu^2; g)$  can be used to give a precise, well justified, prediction for this limit. This illustrates how asymptotic freedom can be used to find out about the behaviour of quantum field theories such as QCD for large momenta when perturbative results show  $\beta(g) < 0$ .

As a final consideration, let us now introduce a mass term, assuming that we have an equation (here for a single coupling  $g$ )

$$\left(\mu \frac{\partial}{\partial \mu} + \beta(g) \frac{\partial}{\partial g} + \gamma_{m^2}(g) m^2 \frac{\partial}{\partial m^2} + \gamma(g)\right) G(g, m^2, \mu) = 0. \quad (4.175)$$

As before we solve this by introducing a running coupling  $g(\mu)$  and also a running mass  $m(\mu)$ , which is determined by the analogous equation

$$\mu \frac{d}{d\mu} m^2 = \gamma_{m^2}(g(\mu)) m^2. \quad (4.176)$$

This can be solved by

$$m^2(\mu) = m^2(\mu_0) e^{\int_{\mu_0}^{\mu} \frac{ds}{s} \gamma_{m^2}(g(s))}. \quad (4.177)$$

constant  $g$ . The solution of the RG equation now becomes

$$G(g(\mu), m^2(\mu), \mu) = e^{-\int_{\mu_0}^{\mu} \frac{ds}{s} \gamma(g(s))} G(g(\mu_0), m^2(\mu_0), \mu_0), \quad (4.178)$$

which reduces to the previous solution when  $m^2 = 0$ . For a function of a single momentum  $p$  we let  $G \rightarrow F(p^2/\mu^2, m^2/\mu^2, g)$  and the solution becomes

$$f\left(\frac{p^2}{\mu^2}, \frac{m^2}{\mu^2}, g(\mu)\right) = e^{\int_{\mu}^p \frac{ds}{s} \gamma(g(s))} F\left(1, \frac{m^2(p)}{p^2}, g(p)\right). \quad (4.179)$$

Now again consider the situation where we take the limit  $p \rightarrow \infty$  and we have an ultraviolet fixed point  $g_*$ , so that  $g(p) \rightarrow g_*$  for  $p \rightarrow \infty$ . In this case

$$\int_{\mu_0}^{\mu} \frac{ds}{s} \gamma_{m^2}(g(s)) \longrightarrow \gamma_{m^2}(g_*) \cdot \log \mu \quad \text{as } \mu \rightarrow \infty. \quad (4.180)$$

So long as  $\gamma_{m^2}(g_*) < 2$  then the dependence on  $m^2$  can be neglected in the asymptotic limit. For asymptotically free theories  $\gamma_{m^2}(g) = O(g^2)$  and the masses can also be neglected in the UV limit.

## 4.4 Effective Potentials

In classical dynamics, if there is a potential  $V(\phi)$ , then the ground state is determined by the minimum of  $V$ . If  $V(\phi_0) = V_{\min}$ , then in the ground state  $\phi = \phi_0$ . This may be degenerate or there may be several minima of  $V(\phi)$  each of which define potential stable ground states. Since in a quantum field theory the classical potential requires additional counterterms it is necessary to reconsider how the ground state is determined.

In quantum field theory, what we mean by the ground state is the vacuum  $|0\rangle$ , which is required to be the state of zero energy. The quantum ground state is determined by a modified *effective potential*  $V_{\text{eff.}}(\phi)$ , which we show here how to define and also how to calculate in perturbative quantum field theory. The essential definition is through the generating functional  $\Gamma[\varphi]$  for connected one-particle irreducible graphs. We have

$$\Gamma[\varphi] \Big|_{\varphi=\text{const.}} = \mathcal{V} V_{\text{eff.}}(\varphi), \quad \mathcal{V} = \int d^d x, \quad (4.181)$$

where  $\mathcal{V}$  is the volume of spacetime (for this to be well defined it is necessary to consider a finite region and then take the limit as the volume becomes large).  $V_{\text{eff.}}(\varphi)$  is equal to the minimum energy density subject  $\langle 0_\varphi | \hat{\phi} | 0_\varphi \rangle = \varphi$ . The quantum vacuum is then  $|0_{\varphi_0}\rangle$  with  $\varphi_0$  determined by the global minimum of  $V_{\text{eff.}}(\varphi)$ .

In perturbation theory  $V_{\text{eff.}}(\phi)$  may be calculated as an expansion with the first term the classical potential  $V(\phi)$ ; we will explain in outline how we can do that, at least in the simplest case, and also show how divergencies are treated in this case. We discuss only the lowest approximation beyond the classical potential, but this can be extended to higher orders. The basic definitions are

$$e^{iW[J]} = \int d[\phi] e^{iS[\phi] + i \int d^d x J(x)\phi(x)}, \quad \Gamma[\varphi] = -W[J] + \int d^d x J(x)\varphi(x), \quad (4.182)$$

where

$$\frac{\delta W[J]}{\delta J(x)} = \varphi(x) = \langle \phi(x) \rangle_J. \quad (4.183)$$

Here  $\langle \cdot \rangle_J$  denotes that it is calculated with the action  $S_J[\phi] = S[\phi] + \int d^d x J(x)\phi(x)$ . The perturbation expansion is derived by first taking  $\phi(x) = \varphi + f(x)$ , with  $\varphi$  here a constant and is sometimes referred to as the *background field*. The action is then expanded in terms of  $f(x)$  to obtain

$$S[\phi] = S[\varphi] + \int d^d x \frac{\delta S[\varphi]}{\delta \varphi(x)} f(x) - \frac{1}{2} \int d^d x f(x) \Delta f(x) + O(f^3). \quad (4.184)$$

For the simple scalar field theory with the action

$$S[\phi] = \int d^d x \left( -\frac{1}{2} \partial \phi \cdot \partial \phi - V(\phi) \right), \quad (4.185)$$

we have

$$\frac{\delta S[\varphi]}{\delta \varphi(x)} := -J_\varphi = \partial^2 \varphi - V'(\varphi) = -V'(\varphi), \quad \text{for } \varphi \text{ const.}, \quad (4.186)$$

and

$$-\int d^d x f(x) \Delta f(x) = \int d^d x (-\partial f \cdot \partial f - V''(\varphi) f^2), \quad \Delta = -\partial^2 + V''(\varphi). \quad (4.187)$$

Taking  $J(x) = J_\varphi$  to cancel the  $O(f)$  terms and neglecting the  $O(f^3)$  terms in the expansion of the action and using  $d[\phi] = d[f]$  gives

$$e^{iW[J_\varphi]} \approx e^{iS[\varphi] + i \int d^d x J_\varphi \varphi} \int d[f] e^{-\frac{i}{2} \int d^d x f(x) \Delta f(x)}, \quad (4.188)$$

and it is evident that

$$\langle f \rangle_{J_\varphi} = \int d[f] f e^{-\frac{i}{2} \int d^d x f(x) \Delta f(x)} = 0 \quad \Rightarrow \quad \langle \phi \rangle_{J_\varphi} = \varphi. \quad (4.189)$$

Hence we recover the relation

$$\left. \frac{\delta W[J]}{\delta J(x)} \right|_{J=J_\varphi} = \varphi, \quad (4.190)$$

and also we have

$$e^{-i\Gamma[\varphi]} = e^{iS[\varphi]} \int d[f] e^{-\frac{i}{2} \int d^d x f(x) \Delta f(x)}. \quad (4.191)$$

The GAUSSIAN functional integral is evaluated as usual giving

$$\int d[f] e^{-\frac{i}{2} \int d^d x f(x) \Delta f(x)} = (\det \Delta)^{-\frac{1}{2}} (\det \Delta_0)^{\frac{1}{2}}, \quad (4.192)$$

where the normalisation is chosen so that when  $V = 0$  the integral will be one, which requires

$$\Delta_0 = -\partial^2. \quad (4.193)$$

We may now take the logarithm to obtain

$$\Gamma[\varphi] := \int d^d x V_{\text{eff.}}(\varphi) = \int d^d x V(\varphi) - \frac{i}{2} (\log \det \Delta - \log \det \Delta_0). \quad (4.194)$$

The additional term involving  $\det \Delta / \det \Delta_0$  is then the first quantum correction to the classical potential.

To calculate the determinants we use the relation  $\log \det \Delta = \text{tr} \log \Delta$ . The trace is obtained by summing over the eigenvalues of the operator  $\Delta$ . Since  $V''(\varphi)$  is a constant the eigenfunctions are given by  $e^{ik \cdot x}$ , with corresponding eigenvalues  $k^2 + V''(\varphi)$ . If the system is in a large box of size  $L$  then, with suitable boundary conditions,  $k = O(L^{-1})$  and is discrete. As in statistical mechanics as  $L \rightarrow \infty$  we may replace the sum over  $k$  by

$$\sum_k \rightarrow \mathcal{V} \int \frac{d^d k}{(2\pi)^d}, \quad (4.195)$$

for  $\mathcal{V} = O(L^d)$  the volume of the box. This gives the result, factoring off  $\mathcal{V}$ ,

$$V_{\text{eff.}}(\varphi) = V(\varphi) - \frac{i}{2} \int \frac{d^d k}{(2\pi)^d} (\log(k^2 + V''(\varphi) - i\varepsilon) - \log(k^2 - i\varepsilon)), \quad (4.196)$$

where the singularities are treated just as in FEYNMAN propagators. Performing a WICK rotation by analytically continuing the contour of  $k_0$ :

$$V_{\text{eff.}}(\varphi) = V(\varphi) + \frac{1}{2} \int \frac{d^d k}{(2\pi)^d} (\log(k^2 + V''(\varphi)) - \log k^2), \quad (4.197)$$

where now  $k^2 > 0$ .

To carry out the integral, we use an integral representation for  $a, b > 0$ :

$$-\log \frac{a}{b} = \int_0^\infty \frac{d\alpha}{\alpha} (e^{-a\alpha} - e^{-b\alpha}), \quad (4.198)$$

and then, for  $a > 0$ ,

$$\int \frac{d^d k}{(2\pi)^d} e^{-ak^2} = \frac{1}{(4\pi a)^{\frac{d}{2}}}. \quad (4.199)$$

Hence we may compute

$$\begin{aligned} V_{\text{eff.}}(\varphi) &= V(\varphi) - \frac{1}{2} \int \frac{d^d k}{(2\pi)^d} \int_0^\infty \frac{d\alpha}{\alpha} \left( e^{-\alpha(k^2 + V''(\varphi))} - e^{-\alpha k^2} \right) \\ &= V(\varphi) - \frac{1}{2} \frac{1}{(4\pi)^{\frac{d}{2}}} \int_0^\infty d\alpha \alpha^{-\frac{d}{2}-1} \left( e^{-\alpha V''(\varphi)} - 1 \right). \end{aligned} \quad (4.200)$$

This is convergent for  $0 < d < 2$ . With an integration by parts and the standard Gamma function integral

$$\begin{aligned} V_{\text{eff.}}(\varphi) &= V(\varphi) + \frac{1}{d} \frac{1}{(4\pi)^{\frac{d}{2}}} \int_0^\infty d\alpha \left( \frac{d}{d\alpha} \alpha^{-\frac{d}{2}} \right) \left( e^{-\alpha V''(\varphi)} - 1 \right) \\ &= V(\varphi) + \frac{1}{d} \frac{1}{(4\pi)^{\frac{d}{2}}} V''(\varphi) \int_0^\infty d\alpha \alpha^{-\frac{d}{2}} e^{-\alpha V''(\varphi)} \\ &= V(\varphi) + \frac{1}{d} \frac{\Gamma(1 - \frac{d}{2})}{(4\pi)^{\frac{d}{2}}} V''(\varphi)^{\frac{d}{2}} = V(\varphi) - \frac{\Gamma(-\frac{d}{2})}{2(4\pi)^{\frac{d}{2}}} V''(\varphi)^{\frac{d}{2}}. \end{aligned} \quad (4.201)$$

Note that this makes sense only when  $V''(\varphi) > 0$ .

The result is valid for general  $d$  but  $\Gamma(-\frac{d}{2})$  has poles at  $d = 0, 2$  and  $d = 4$  reflecting divergencies. In particular

$$\Gamma\left(-\frac{d}{2}\right) \sim \frac{1}{\varepsilon} e^{-\frac{1}{2}\gamma\varepsilon} \left(1 + \frac{3}{4}\varepsilon\right), \quad d = 4 - \varepsilon. \quad (4.202)$$

This pole is removed by adding the counterterm potential

$$V_{\text{c.t.}}(\varphi) = \frac{\mu^{-\varepsilon}}{32\pi^2\varepsilon} V''(\varphi)^2. \quad (4.203)$$

where the arbitrary mass  $\mu$  has been introduced to ensure dimensional consistency since  $V(\varphi)$  has dimension  $d$  and  $V''(\varphi)$  has dimension 2. Since  $V''(\varphi)^{\frac{d}{2}} \sim V''(\varphi)^2 \left(1 - \frac{1}{2}\varepsilon \log V''(\varphi)\right)$  then

$$\begin{aligned} V_{\text{eff.,ren.}}(\varphi) &= \left( V_{\text{eff.}}(\varphi) + V_{\text{c.t.}}(\varphi) \right) \Big|_{\varepsilon \rightarrow 0} \\ &= V(\varphi) + \frac{1}{64\pi^2} V''(\varphi)^2 \left( \log \frac{V''(\varphi)}{\hat{\mu}^2} - \frac{3}{2} \right), \quad \hat{\mu}^2 = 4\pi e^{-\gamma} \mu^2. \end{aligned} \quad (4.204)$$

It is important to recognise that  $V_{\text{eff.,ren.}}(\varphi)$  is, as a consequence of the necessity of adding counterterms to ensure finiteness, arbitrary up to the addition of a finite quartic polynomial in  $\varphi$ . Thus in this result the coefficient of  $V''(\varphi)^2$ , as opposed to that for  $V''(\varphi)^2 \ln V''(\varphi)$ , has no physical significance. This freedom can be removed by specifying the derivatives  $V_{\text{eff.,ren.}}^{(n)}(0)$ ,  $n = 1, 2, 3, 4$ , as the parameters on which the theory depends (if the theory has a  $\phi \leftrightarrow -\phi$  symmetry, only  $n = 2, 4$  are relevant). Note that, from the relation to  $\Gamma[\varphi]$ , we have  $V_{\text{eff.,ren.}}^{(n)}(0) = -\hat{\tau}_n(0, \dots, 0)_{\text{ren.}}$ .

It is the effective potential whose minima determine the ground state for a quantum field theory. These may be different from those for the classical theory, even if the parameters describing each are matched in some way. The finite  $V_{\text{eff.,ren.}}(\varphi)$  depends on the arbitrary scale  $\mu$  which is introduced through regularisation of the Feynman integrals for vacuum diagrams that are used to calculate it. In consequence it satisfies an RG equation which has the typical form, if there is one coupling  $g$ ,

$$\left( \mu \frac{\partial}{\partial \mu} + \beta(g) \frac{\partial}{\partial g} - \gamma_\phi(g) \varphi \frac{\partial}{\partial \varphi} \right) V_{\text{eff.,ren.}}(\varphi) = 0. \quad (4.205)$$

## 5 Gauge Theories

Up to now we have mainly used scalar field theory as an example of a quantum field theory; the point is that realistic theories involve gauge fields and fermions. Associated with each gauge field is a gauge group, which is usually a continuous LIE<sup>37</sup> group. In the most important examples<sup>38</sup>, these are

Theory:	QED	WEINBERG-SALAM model	QCD,
Gauge Group:	$U(1)$	$SU(2) \times U(1)$	$SU(3)$ .

The gauge fields are vector fields, so they have a LORENTZ index  $A_\mu(x)$ , and they belong to the LIE algebra  $\mathfrak{g}$  of the LIE group  $G$ . Denoting the set of all vector fields taking values in  $\mathfrak{g}$  by  $\mathcal{A}$ , we can write this as

$$A_\mu \in \mathcal{A}. \quad (5.1)$$

In a formal sense, the gauge group  $\mathcal{G}$  is defined by

$$\mathcal{G} \simeq \bigotimes_x G_x, \quad (5.2)$$

i.e. an element of  $\mathcal{G}$  is a map from spacetime points to elements of the LIE group  $G$  (this becomes precise when spacetime is approximated by a lattice).

### 5.1 Brief Summary of LIE Algebras and Gauge Fields

For a continuous LIE group  $G$  the elements  $g(\theta)$  depend on parameters  $\theta_r$ ,  $r = 1, \dots, \dim G$ , where everything is continuous and differentiable with respect to  $\theta$ . (When considering gauge groups, the parameters  $\theta$  are taken to be functions of the spacetime points  $x$ .) The group structure of  $G$  means that for any given  $\theta, \theta'$ ,

$$g(\theta)g(\theta') = g(\theta''), \quad (5.3)$$

for some  $\theta''$ . Generally  $g(0) = e$ , the identity. A LIE algebra  $\mathfrak{g}$  is a vector space equipped with a LIE bracket  $[\cdot, \cdot]$ , so that

$$X, Y \in \mathfrak{g} \Rightarrow [X, Y] \in \mathfrak{g}. \quad (5.4)$$

The LIE bracket is antisymmetric and satisfies a JACOBI identity.

$$[X, Y] = -[Y, X], \quad [[X, Y], Z] + [[Z, X], Y] + [[Y, Z], X] = 0. \quad (5.5)$$

We can conjugate elements of the Lie algebra by group elements,

$$g^{-1}Xg \in \mathfrak{g}, \quad g \in G. \quad (5.6)$$

For a small change in  $g$

$$g^{-1}dg \in \mathfrak{g}, \quad (5.7)$$

and there is also an exponentiation map from the LIE algebra to a one parameter subgroup of LIE group:

$$\exp : \mathfrak{g} \rightarrow G; \quad X \rightarrow g_t = \exp(tX). \quad (5.8)$$

We can take a basis  $\{t_a\}$ ,  $a = 1, \dots, \dim G$ , for  $\mathfrak{g}$ , so that any  $X \in \mathfrak{g}$  can be written as  $X = X_a t_a$ , and define structure constants  $f_{abc}$  by

$$[t_a, t_b] = f_{abc} t_c, \quad (5.9)$$

where the basis may be chosen so that  $f_{abc}$  is totally antisymmetric. With a basis we have

$$g(\theta)^{-1}dg(\theta) = t_a l_{ar}(\theta) d\theta_r, \quad (5.10)$$

<sup>37</sup>Lie, Sophus (1842-1899)

<sup>38</sup>Weinberg, Steven (1933-), Salam, Abdus (1926-1996), Nobel Prizes 1979

and we may choose  $l_{ar}(0) = \delta_{ar}$ . It is easy to see that

$$g_0 g(\theta) = g(\theta') \quad \Rightarrow \quad l_{ar}(\theta) d\theta_r = l_{ar}(\theta') d\theta'_r, \quad (5.11)$$

for fixed  $g_0$ . Under the change of variables  $\theta \rightarrow \theta'$ , the JACOBIAN  $\det[\partial\theta'/\partial\theta] = \det l(\theta)/\det l(\theta')$  and we may define invariant integration over the group by

$$d\mu(g) = \det l(\theta) \prod_r d\theta_r \quad \Rightarrow \quad \int d\mu(g) f(g) = \int d\mu(g) f(g_0 g). \quad (5.12)$$

For compact groups  $\int_G d\mu(g)$  is finite.

With a basis then for any  $X \in \mathfrak{g}$  there is a corresponding matrix defined by

$$[t_a, X] = T_{ab}(X) t_b. \quad (5.13)$$

Clearly

$$t_{ab}(t_c) = f_{acb}. \quad (5.14)$$

The matrices  $\underline{T}(X) = \{T_{ab}(X)\}$  form a representation of the Lie algebra since, as a consequence of the Jacobi identity,  $[\underline{T}(X), \underline{T}(Y)] = \underline{T}([X, Y])$ , where we use standard matrix multiplication. This is called the *adjoint representation* of the Lie algebra, the matrices have dimension  $\dim G \times \dim G$  where the parameters  $\theta$  have dimension  $\dim G$  (note that  $\dim SU(2) = 3$ , whereas  $\dim SU(3) = 8$ ). The adjoint representation can be extended to  $G$  by  $g^{-1} t_a g = D_{ab}(g) t_b$ .

There is also an quadratic form  $X \cdot Y$  which is invariant under a conjugation

$$X \cdot Y = g^{-1} X g \cdot g^{-1} Y g. \quad (5.15)$$

An equivalent relation for the Lie algebra, obtained for  $g \rightarrow g_t = \exp(tZ)$  and letting  $t \rightarrow 0$ , is

$$[X, Z] \cdot Y + X \cdot [Y, Z] = 0. \quad (5.16)$$

If  $G$  is compact the scalar product is positive definite. By a suitable change of basis one can then arrange

$$t_a \cdot t_b = \delta_{ab}. \quad (5.17)$$

For simple Lie groups, those not of the form  $G \times G'$ , the scalar product is unique.

A *gauge transformation* of a gauge field  $A_\mu(x)$  by an element of the gauge group  $g(x)$ , i.e.  $g(x) \in G$  for each  $x$ , is defined by

$$A_\mu(x) \rightarrow A_\mu^g(x) := g(x)^{-1} A_\mu(x) g(x) + g(x)^{-1} \partial_\mu g(x). \quad (5.18)$$

In the case of  $G = U(1)$ , we can write  $g(x) = e^{i\lambda(x)}$ , so that

$$A_\mu^g(x) = A_\mu(x) + i\partial_\mu \lambda(x). \quad (5.19)$$

The gauge field may be expanded

$$A_\mu = A_{\mu,a} t_a, \quad (5.20)$$

for  $a = 1, \dots, \dim G$ , and plays the role of a connection similar to general relativity; the corresponding curvature is

$$f_{\mu\nu} = \partial_\mu A_\nu - \partial_\nu A_\mu + [A_\mu, A_\nu]. \quad (5.21)$$

Under a gauge transformation,

$$f_{\mu\nu}(x) \rightarrow F_{\mu\nu}^g(x) = g(x)^{-1} f_{\mu\nu}(x) g(x), \quad (5.22)$$

where  $F_{\mu\nu}^g(x)$  is the curvature formed from the transformed connection  $A_\mu^g(x)$ . Unlike  $A_\mu$ ,  $F_{\mu\nu}$  transforms homogeneously under gauge transformations.

With the connection we can define a *covariant derivative* acting on fields  $\phi$  belonging to a representation space  $V_\phi$  for the Lie algebra

$$d_\mu \phi = \partial_\mu \phi + A_\mu \phi, \quad (5.23)$$



where

$$A_\mu = A_{\mu,a} T_a, \quad (5.24)$$

forming  $T_a$  form a representation of the LIE algebra, i.e. they are matrices acting on  $V_\phi$  satisfying  $[T_a, T_b] = f_{abc} T_c$ . Under a gauge transformation  $\phi \rightarrow \phi^g = R(g)\phi$ , where  $R(g)$  is the matrix corresponding to  $g$  in the representation defined on  $V_\phi$ . The gauge transformations are defined so that  $(D_\mu \phi)^g = D_\mu^g \phi^g$ . It is straightforward to see that we can write

$$[D_\mu, D_\nu] = F_{\mu\nu,a} T_a. \quad (5.25)$$

The gauge fields belong to the representation space for the adjoint representation so that the covariant derivative becomes

$$(D_\lambda F_{\mu\nu})_a = \partial_\lambda F_{\mu\nu,a} + [A_\lambda, F_{\mu\nu}]_a = \partial_\lambda F_{\mu\nu,a} + T_{ab}(A_\lambda) F_{\mu\nu,b}. \quad (5.26)$$

Also for an infinitesimal gauge transformation

$$\delta A_\mu = D_\mu \lambda, \quad (5.27)$$

for  $D_\mu$  the adjoint covariant derivative and  $\lambda$  belongs to the Lie algebra for  $\mathcal{G}$ , formed by fields  $\lambda_a(x)$  with  $\lambda_a(x) t_a \in \mathfrak{g}$ .

The curvature satisfies the crucial BIANCHI<sup>39</sup> identity, which may be obtained by using the JACOBI identity for  $[D_\lambda, [D_\mu, D_\nu]]$ ,

$$d_\lambda F_{\mu\nu} + D_\nu F_{\lambda\mu} + D_\mu F_{\nu\lambda} = 0, \quad (5.28)$$

for  $D_\mu$  the adjoint covariant derivative as above.

## 5.2 Gauge Fields in Quantum Field Theory

The simplest gauge invariant scalar which forms a LAGRANGIAN is

$$\mathcal{L} = -\frac{1}{4g^2} F^{\mu\nu} \cdot F_{\mu\nu}, \quad (5.29)$$

where  $g$  is introduced as a overall coefficient and is the coupling for the gauge theory. The corresponding action is then

$$S[A] = \int d^d x \mathcal{L}(x). \quad (5.30)$$

Clearly  $S[A] = S[A^g]$ . There is no constraint on the dimension. The variational equations  $\delta S = 0$  give the equations of motion

$$\boxed{D^\mu F_{\mu\nu} = 0.} \quad (5.31)$$

These equations do not depend on  $g$  which is irrelevant classically.

Let us suppose that  $A_\mu(x)$  is a solution to these equations, then, as a consequence of gauge invariance,  $A_\mu^g(x)$  is also a solution for any element  $g(x)$  of the gauge group. Since  $g(x)$  is unconstrained the dynamical equations do not have unique solutions given some initial conditions on  $A_\mu(x)$  and its time derivative at some initial time. It follows that gauge theories have redundant degrees of freedom which do not have any dynamical role. At the classical level this is not too important (for abelian electrodynamics  $F_{\mu\nu}$  is gauge invariant), but it leads to potential problems in quantisation. The dynamical variables in this gauge theory really belong to the equivalence class of gauge fields modulo gauge transformations

$$\mathcal{A}/\mathcal{G} = \{A_\mu \sim A_\mu^g : A_\mu \in \mathcal{A}, g \in \mathcal{G}\}. \quad (5.32)$$

The set  $\{A^g\}$  for all  $g \in \mathcal{G}$  forms the orbit of  $A$  under the action of  $\mathcal{G}$ . The space of gauge fields  $\mathcal{A}$  is a linear space, if  $A_\mu, A'_\mu \in \mathcal{A}$  then so is  $aA_\mu + a'A'_\mu$ , and so is topologically trivial but the space of orbits or  $\mathcal{A}/\mathcal{G}$  is nontrivial in a topological sense. The dynamical variables in a

<sup>39</sup>Bianchi, Luigi (1856-1928)

gauge theory are coordinates on  $\mathcal{A}/\mathcal{G}$  so that there is a well defined initial value problem and quantisation can be achieved.

To exhibit the potential difficulties in quantising we first consider a canonical approach. When quantising a classical theory given by a LAGRANGIAN  $L(q^i, \dot{q}^i)$ , one first defines the conjugate momenta by

$$p_i = \frac{\partial L}{\partial \dot{q}^i}, \quad (5.33)$$

which gives  $p_i(q, \dot{q})$ . It is crucial that this should be invertible so that we can write  $\dot{q}^i(q, p)$ . For a gauge theory we let  $q^i \rightarrow A_\mu(\vec{x})$ . Then the conjugate momenta are given by

$$\frac{\partial \mathcal{L}}{\partial \dot{A}_i} = -\frac{1}{g^2} F^{0i}, \quad \frac{\partial \mathcal{L}}{\partial \dot{A}_0} = 0. \quad (5.34)$$

$\mathcal{L}$  does not depend on  $\dot{A}_0$ , but if we vary  $A_0$ , we get from  $\delta S = 0$ ,

$$d_i F^{0i} = 0, \quad (5.35)$$

which is a non dynamical equation, without  $t$  derivatives, similar to  $\vec{\nabla} \cdot \vec{E} = 0$  in vacuum electrodynamics. There is no momentum conjugate to  $A_0$ , it is not a dynamical variable, but it acts as a LAGRANGE multiplier enforcing a constraint.

Another related problem arises when expanding  $S[A]$ , which contains quadratic, cubic and quartic terms in  $A$ . Consider just the quadratic terms then

$$S[A] = \frac{1}{2g^2} \int d^d x \left( -A^\nu \cdot (\Delta A)_\nu + O(A^3) \right), \quad (5.36)$$

where

$$(\Delta A)_\nu = -\partial^2 A_\nu + \partial_\nu \partial^\mu A_\mu. \quad (5.37)$$

In quantum field theory then, for a perturbation approach in terms of FEYNMAN diagrams, we need to invert  $\Delta$  to define the FEYNMAN propagator. But it is easy to see that for any function  $\lambda$

$$(\Delta \partial \lambda)_\nu = 0, \quad (5.38)$$

which is a consequence of  $S[A^g] = S[A]$ . We cannot then invert  $\Delta$  in a straightforward fashion so that there is no direct perturbative expansion with the cubic and higher order terms defining the interaction.

These issues no longer arise if the dynamical variables are regarded as belonging to  $\mathcal{A}/\mathcal{G}$  instead of  $\mathcal{A}$ . In a functional integral approach this requires that the quantum field theory is defined by

$$\int_{\mathcal{A}/\mathcal{G}} d\mu[A] e^{iS[A]}, \quad (5.39)$$

where is some measure on  $\mathcal{A}/\mathcal{G}$  that we need to define. In general we require that

$$\int_{\mathcal{A}} d[A] = \int_{\mathcal{G}} d\mu[g] \int_{\mathcal{A}/\mathcal{G}} d\mu[A], \quad (5.40)$$

where the integration over the gauge group  $\mathcal{G}$  is required to satisfy

$$\int_{\mathcal{G}} d\mu[g] F[g] = \int_{\mathcal{G}} d\mu[g] F[g_0 g] \quad \text{for any } g_0 \in \mathcal{G}. \quad (5.41)$$

There is a standard prescription for constructing the required measure on  $\mathcal{A}/\mathcal{G}$  which is to consider an integration over all fields  $d[A]$  and impose a gauge fixing condition  $F(A) = 0$ , where  $F(A)$  depends locally on  $A_\mu(x)$  and its derivatives and for each  $x$   $F(A) \in \mathfrak{g}$ . We assume that

$$F(A^g) = 0, \quad \text{for all } A \in \mathcal{A} \text{ for some unique } g \in \mathcal{G}. \quad (5.42)$$

With these requirements the gauge condition  $F(A) = 0$  selects a unique gauge field  $A_\mu$  on each gauge orbit. Actually this is not possible in general for any  $A$ , because  $\mathcal{A}/\mathcal{G}$  is topologically

non trivial, but it is feasible for small  $A$ , and this is sufficient in perturbation theory. It is also essential for the functional integral to be just on  $\mathcal{A}/\mathcal{G}$  that the results are independent of the particular choice of the gauge fixing function  $F(A)$ .

To achieve these requirements we suppose that

$$\int_{\mathcal{A}/\mathcal{G}} d\mu[A] = \int_{\mathcal{A}} d[A] \cdot \delta[F(A)] \cdot M[A], \quad (5.43)$$

where we have included a functional delta function imposing the gauge fixing condition and also have introduced the function  $M[A]$ , defined for  $A$  satisfying  $F(A) = 0$ , which compensates for the choice of  $F$ . This is achieved by requiring

$$\int_{\mathcal{G}} d\mu[g] \delta[F(A^g)] \cdot M[A] = 1 \quad (5.44)$$

for any given  $A$ . Using invariance of the group integration  $M(A^{g_0}) = M[A]$ . By assumption (5.42) there exists a unique  $g_0$  such that  $F(A^{g_0}) = 0$  so that the only contribution to the integral is for  $g \approx g_0$ . It is easy to see by letting  $A \rightarrow A^{g_0}$  it is sufficient to assume  $g_0 = e$ , the identity. We then note that, since then  $A_{\mu}^{g_0} = A_{\mu} + D_{\mu}\lambda$  where  $D_{\mu}$  is the adjoint covariant derivative,

$$F[A] = 0 \quad \Rightarrow \quad F[A^g] = F'(A)^{\mu} D_{\mu}\lambda =: \Delta_{\text{gh}}\lambda, \quad (5.45)$$

where we define

$$\Delta_{\text{gh}} = F'(A)^{\mu} D_{\mu}. \quad (5.46)$$

In the neighbourhood of the identity, with a suitable normalisation  $d\mu[g]|_{g \approx e} = d[\lambda]$ , where  $d[\lambda]$  denotes the functional integration measure over fields  $\lambda(x) \in \mathfrak{g}$  which is a linear space. Hence we have

$$\int_{\mathcal{G}} d\mu[g] \delta[F(A^g)] = \int d[\lambda] \delta[\Delta_{\text{gh}}\lambda] = (\det \Delta_{\text{gh}})^{-1}, \quad (5.47)$$

so that the integration has been reduced to one over fields belonging to the LIE algebra  $\mathfrak{g}$  of the gauge group  $G$ .  $\Delta_{\text{gh}}$  is called the *ghost operator*, for reasons which will become apparent later on and in (5.44) we must take

$$M[A] = \det \Delta_{\text{gh}}. \quad (5.48)$$

It is important to note that if  $\Delta_{\text{gh}}\lambda = 0$  for some  $\lambda$  then this is a signal that the gauge fixing condition does not fix the gauge uniquely as in (5.42).

The functional integral over the gauge fields may now be written as

$$\begin{aligned} \int_{\mathcal{A}} d[A] e^{iS[A]} &= \int_{\mathcal{A}} d[A] \int_{\mathcal{G}} d\mu[g] \delta[F(A^g)] M[A] e^{iS[A]} = \int_{\mathcal{G}} d\mu[g] \int_{\mathcal{A}} d[A] \delta[F(A^g)] M[A] e^{iS[A]} \\ &= \int_{\mathcal{G}} d\mu[g] \int_{\mathcal{A}} d[A^g] \delta[F(A^g)] M[A^g] e^{iS[A^g]} \\ &= \int_{\mathcal{G}} d\mu[g] \int_{\mathcal{A}} d[A] \delta[F(A)] M[A] e^{iS[A]}, \end{aligned} \quad (5.49)$$

where we use that  $d[A]$ ,  $M[A]$ ,  $S[A]$  are invariant under  $A \rightarrow A^g$ . Hence finally we may identify

$$\int_{\mathcal{A}/\mathcal{G}} d\mu[A] e^{iS[A]} = \int_{\mathcal{A}} d[A] \delta[F(A)] \det \Delta_{\text{gh}} e^{iS[A]}, \quad (5.50)$$

with  $\Delta_{\text{gh}}$  determined by the choice of gauge fixing function  $F(A)$ .

### 5.3 Example: Ordinary Finite Integral

To illustrate how this works we discuss an example for an ordinary finite integral which realises the same issues as for a functional integral over gauge fields. For a vector  $\underline{x} \in \mathbb{R}^n$  we consider the following integral:

$$\int d^n x f(\underline{x}). \quad (5.51)$$

We assume  $f(\underline{x})$  is invariant under the symmetry group  $SO(n)$ , so that

$$f(\underline{x}) = f(\underline{x}') \quad \text{for all } \underline{x}' = \underline{R}\underline{x}, \quad \underline{R} \in SO(n). \quad (5.52)$$

Since for

$$\underline{x} \rightarrow \underline{x}' = \underline{R}\underline{x}, \quad d^n x' = d^n x, \quad (5.53)$$

as  $\det R = 1$  the integral is invariant.  $SO(n)$  here plays the role of a gauge group and the orbit of  $x$  under the action of  $SO(n)$  is a sphere of radius  $|x|$ .

For this example we know how to evaluate the integral since

$$f(\underline{x}) = \hat{f}(r), \quad r = |\underline{x}|, \quad (5.54)$$

we may integrate over angles giving

$$\int d^n x f(\underline{x}) = S_n \int_0^\infty dr r^{n-1} \hat{f}(r), \quad (5.55)$$

where  $S_n = \frac{2\sqrt{\pi}^n}{\Gamma(\frac{n}{2})}$  is the area of an  $(n-1)$ -dimensional unit sphere.

We now approach this integral in the same fashion as the gauge field functional integral by using a gauge fixing condition. In this case it is clear that by a rotation  $\underline{R}$  we can always arrange

$$\underline{x} \rightarrow \underline{x}_0 := r(0, 0, \dots, 0, 1). \quad (5.56)$$

This gauge fixing condition is then to set  $\underline{x} = \underline{x}_0$  which can be realised by introducing

$$\delta(F(\underline{x})) := \theta(x_n) \prod_{i=1}^{n-1} \delta(x_i), \quad (5.57)$$

into the integral. To ensure complete fixing of the gauge freedom for  $\underline{x}$  we also require  $x_n > 0$ . Just as before, we also introduce a function  $M(\underline{x})$  by the requirement

$$\int_{SO(n)} d\mu(R) \delta(F(\underline{R}\underline{x})) M(\underline{x}) = 1, \quad (5.58)$$

where  $d\mu(R)$  is the invariant measure for integration over  $SO(n)$ . In this example the gauge fixing condition does not determine  $\underline{R}$  uniquely since there is a subgroup  $SO(n-1) \subset SO(n)$ , acting on the first  $(n-1)$ -components, such that for  $\underline{R}' \in SO(n-1)$  then  $\underline{R}'\underline{x}_0 = \underline{x}_0$ . For the Lie algebra then if  $\{t_a\}$   $a = 1, 2, \dots, \frac{1}{2}n(n-1)$ , are antisymmetric matrices forming the generators of  $SO(n)$  then we may decompose  $\{t_a\} = \{\hat{t}_i, t_s\}$  so that

$$\hat{t}_i \underline{x}_0 = 0, \quad i = 1, \dots, \frac{1}{2}(n-1)(n-2), \quad (5.59)$$

with  $\hat{t}_i$  the generators for the  $SO(n-1)$  subgroup, while the remaining generators  $t_s$  then satisfy

$$t_s \underline{x}_0 = r(0, \dots, \underbrace{1}_{s'\text{th place}}, \dots, 0), \quad s = 1, \dots, n-1. \quad (5.60)$$

To calculate  $M(\underline{x})$  we need only consider rotations  $\underline{R}$  of the form

$$\underline{R} = (1 + \theta_s t_s) \underline{R}' \quad \text{neglecting } O(\theta_s \theta_{s'}). \quad (5.61)$$

For such  $\underline{R}$

$$\underline{R}\underline{x}_0 = r(\theta_1, \dots, \theta_{n-1}, 1) + O(\theta_s \theta_{s'}), \quad (5.62)$$

and therefore

$$\delta(F(\underline{R}\underline{x}_0)) = \prod_{i=1}^{n-1} \delta(r\theta_i). \quad (5.63)$$

The integration measure may be defined so that

$$d\mu(\underline{R}) = d\mu(\underline{R}') \prod_{s=1}^{n-1} d\theta_s (1 + O(\theta_{s'})). \quad (5.64)$$

The required integral then becomes

$$\int_{SO(n)} d\mu(\underline{R}) \delta(F(\underline{R}, \underline{x}_0)) = \int_{SO(n-1)} d\mu(\underline{R}') \int \prod_{s=1}^{n-1} d\theta_s \delta(r\theta_s) = \frac{V_{SO(n-1)}}{r^{n-1}}, \quad (5.65)$$

where  $V_{SO(n-1)} = \int d\mu(\underline{R}')$  is the volume of the group  $SO(n-1)$ . Hence we choose the function  $M$  to be

$$m(\underline{x}) = \frac{r^{n-1}}{V_{SO(n-1)}}. \quad (5.66)$$

Note that  $M(\underline{R}\underline{x}) = M(\underline{x})$ .

Following the same procedure as used for the gauge invariant case the  $SO(n)$  invariant integral can be rewritten as

$$\begin{aligned} \int d^n x f(\underline{x}) &= \int d^n x \int_{SO(n)} d\mu(\underline{R}) \delta(F(\underline{R}, \underline{x})) M(\underline{x}) f(\underline{x}) \\ &= \frac{1}{V_{SO(n-1)}} \int_{SO(n)} d\mu(\underline{R}) \int d^n x \delta(F(\underline{R}, \underline{x})) r^{n-1} f(\underline{x}_0) \\ &= \frac{1}{V_{SO(n-1)}} \int_{SO(n)} d\mu(\underline{R}) \int d^n x \theta(x_n) \prod_i \delta(x_i) r^{n-1} f(\underline{x}_0) \\ &= \frac{V_{SO(n)}}{V_{SO(n-1)}} \int_0^\infty dr r^{n-1} f(\underline{x}_0), \end{aligned} \quad (5.67)$$

where the final integration is just over  $x_n = r > 0$ . This is equal to the result obtained by integrating over angles if we use

$$S_n = \frac{V_{SO(n)}}{V_{SO(n-1)}}. \quad (5.68)$$

## 5.4 Introduction of Ghost Fields

Returning to the functional integral of a gauge field theory we consider then

$$\int_A d[A] \delta[F(A)] \det \Delta_{\text{gh}}(A) e^{iS[A]}, \quad (5.69)$$

where

$$S[A] = -\frac{1}{4g^2} \int d^d x F^{\mu\nu}(x) \cdot F_{\mu\nu}(x), \quad (5.70)$$

and we note that in general the ghost operator depends on the gauge field  $A$ . If it does not the corresponding determinant can be factored out of the functional integral and absorbed in the overall arbitrary normalisation constant. It remains to show how the expansion of this functional integral can be expressed in term of appropriate Feynman rules. To achieve this we seek a representation in which all factors are present in an exponential

First of all, rewrite

$$\delta[F(A)] = \int d[b] e^{\frac{i}{g^2} \int d^d x b(x) \cdot F(A)}, \quad (5.71)$$

where  $b(x)$  is a BOSONIC field, which like  $F_{\mu\nu}$  and  $F(A)$ , belongs to the LIE algebra. This functional integral is the functional analogue of the usual formula for the  $\delta$ -function. The prefactor of  $\frac{1}{g^2}$  has been introduced for later convenience. Also let us rewrite the determinant as a function integral over GRASSMANN fields, as shown section 2.3,

$$\det \Delta_{\text{gh}}(A) = \int d[\bar{c}] d[c] e^{iS_{\text{gh}}[\bar{c}, c, A]}, \quad (5.72)$$

where

$$S_{gh}[\bar{c}, c, A] = \frac{1}{g^2} \int d^d x \bar{c}(x) \cdot \Delta_{gh}(A)c(x). \quad (5.73)$$

$\bar{c}$  and  $c$  are here FERMION scalar fields, which also belong to the LIE algebra, and are treated as independent fields. They are called *ghost fields* since they are unphysical because they do not correspond to physical particles, having the wrong statistics.

The function integral then becomes

$$\int d[A]d[b]d[\bar{c}]d[c] e^{iS_q[A,b,c,\bar{c}]}, \quad (5.74)$$

where the quantum action is given by

$$S_q[A, b, c, \bar{c}] = \frac{1}{g^2} \int d^d x \left( -\frac{1}{4} F^{\mu\nu}(x) \cdot F_{\mu\nu}(x) + b(x) \cdot F(A) + \bar{c}(x) \cdot \Delta_{gh}(A)c(x) \right). \quad (5.75)$$

The additional auxiliary field  $b$  adds an additional degree of freedom while the GRASSMANN ghost fields  $\bar{c}, c$  subtract two degrees of freedom so that the net degrees of freedom correspond to that for gauge fields modulo gauge transformations.

There is a further generalisation which extends the notion of gauge fixing introduced above. It is sufficient, in order to produce a well defined theory, to have a family of gauge fixing conditions which are then summed or integrated over. Thus we consider a gauge fixing condition  $F(A) = f$  where  $f(x) \in L_G$  and we integrate with GAUSSIAN weight function

$$\begin{aligned} \delta[F(A)] &\rightarrow \int d[f] \delta[F(A) - f] e^{-\frac{i}{g^2} \frac{1}{2\xi} \int d^d x f(x) \cdot f(x)} = e^{-\frac{i}{g^2} \frac{1}{2\xi} \int d^d x F(A) \cdot F(A)} \\ &= \int d[b] e^{\frac{i}{g^2} \int d^d x (b(x) \cdot F(A) + \frac{1}{2} \xi b(x) \cdot b(x))}, \end{aligned} \quad (5.76)$$

where in the last line the same expression is obtained by extending the  $b$ -functional integral by a quadratic term. This is easily evaluated, up to an irrelevant overall constant, by completing the square, assuming a convenient choice of scale for the  $b$  functional integral. The choice of gauge now depends on  $F(A)$  and  $\xi$ . To go back to the previous case when  $F(A) = 0$  requires taking the limit  $\xi \rightarrow 0$ .

In consequence the quantum action has been extended to

$$S_q[A, b, c, \bar{c}] = \frac{1}{g^2} \int d^d x \left( -\frac{1}{4} F^{\mu\nu}(x) \cdot F_{\mu\nu}(x) + b(x) \cdot F(A) + \frac{1}{2} \xi b(x) \cdot b(x) + \bar{c}(x) \cdot \Delta_{gh}(A)c(x) \right). \quad (5.77)$$

For many calculations it is sufficient to consider a very simple choice, the linear covariant gauge

$$f(A) = \partial^\mu A_\mu. \quad (5.78)$$

This maintains LORENTZ invariance. In this case  $F'(A)^\mu = \partial^\mu$  and

$$\Delta_{gh} = \partial^\mu D_\mu. \quad (5.79)$$

## 5.5 FEYNMAN Rules for Gauge Theories

Let us try and set up a perturbative expansion; although it can be considered as an independent field it is simplest to eliminate  $b$  essentially by completing the square. We can then write the action as

$$S_q[A, c, \bar{c}] = \frac{1}{g^2} \int d^d x \left( -\frac{1}{4} F^{\mu\nu} \cdot F_{\mu\nu} - \frac{1}{2\xi} \partial^\mu A_\mu \cdot \partial^\nu A_\nu - \partial^\mu \bar{c} \cdot D_\mu c \right). \quad (5.80)$$

This allows the FEYNMAN rules to be derived in an essentially straightforward fashion, with diagrams involving lines and vertices for the fields  $A_\mu, c$  and  $\bar{c}$ .

Look first of all at the quadratic (free) part of the action:

$$\begin{aligned}
S_q[A, c, \bar{c}]_{\text{quad}} &= \frac{1}{g^2} \int d^d x \left( -\frac{1}{2} \partial^\mu A^\nu \cdot (\partial_\mu A_\nu - \partial_\nu A_\mu) - \frac{1}{2\xi} \partial^\mu A_\mu \cdot \partial^\nu A_\nu - \partial^\mu \bar{c} \cdot \partial_\mu c \right) \\
&= \frac{1}{g^2} \int d^d x \left( \frac{1}{2} A_\mu \cdot \left( \partial^2 \eta^{\mu\nu} - \left(1 - \frac{1}{\xi}\right) \partial^\mu \partial^\nu \right) A_\nu + \bar{c} \cdot \partial^2 c \right) \\
&= - \int d^d x \left( \frac{1}{2} A_\mu \cdot \Delta^{\mu\nu} A_\nu - \bar{c} \cdot \partial^2 c \right), \tag{5.81}
\end{aligned}$$

where

$$\Delta^{\mu\nu} = -\partial^2 \eta^{\mu\nu} + \left(1 - \frac{1}{\xi}\right) \partial^\mu \partial^\nu, \tag{5.82}$$

and in the last step we removed the overall factor  $1/g^2$  by redefining

$$A_\mu \rightarrow g A_\mu, \quad c, \bar{c} \rightarrow g c, g \bar{c}. \tag{5.83}$$

From this we may obtain the two-point functions

$$\langle A_{\mu a}(x) A_{\nu b}(y) \rangle, \quad \langle c_a(x) \bar{c}_b(y) \rangle. \tag{5.84}$$

As was shown in the case of scalar fields the propagators are just the Green functions for the differential operators that appear in the quadratic part of the action except there are now LORENTZ and group indices to take account of

$$i \Delta_x^{\mu\lambda} \langle A_{\lambda a}(x) A_{\nu b}(y) \rangle = \delta_{ab} \delta_\nu^\mu \delta^d(x-y), \tag{5.85}$$

$$-i \partial_x^2 \langle c_a(x) \bar{c}_b(y) \rangle = \delta_{ab} \delta^d(x-y). \tag{5.86}$$

The standard procedure to solve these equations is by considering FOURIER transformations:

$$\int d^d x e^{-ip \cdot x} \langle A_{\mu a}(x) A_{\nu b}(0) \rangle =: i \delta_{ab} \tilde{\Delta}_{F, \mu\nu}(p), \tag{5.87}$$

$$\int d^d x e^{-ip \cdot x} \langle c_a(x) \bar{c}_b(0) \rangle =: i \delta_{ab} \tilde{\Delta}_F(p), \tag{5.88}$$

so that we have to solve

$$-\left( p^2 \eta^{\mu\lambda} - \left(1 - \frac{1}{\xi}\right) p^\mu p^\lambda \right) \tilde{\Delta}_{F, \lambda\nu}(p) = \delta_\nu^\mu, \tag{5.89a}$$

$$-p^2 \tilde{\Delta}_F(p) = 1. \tag{5.89b}$$

These are pretty straightforward to invert:

$$\begin{aligned}
\tilde{\Delta}_{F, \mu\nu}(p) &= -\frac{\eta_{\mu\nu}}{p^2 - i\epsilon} + (1 - \xi) \frac{p_\mu p_\nu}{(p^2 - i\epsilon)^2}, \\
\tilde{\Delta}_F(p) &= -\frac{1}{p^2 - i\epsilon}.
\end{aligned}$$

We therefore get the following propagators:

- For a gauge field propagator, introduce a wavy line:



It corresponds to

$$i \delta_{ab} \left( -\frac{\eta_{\mu\nu}}{p^2 - i\epsilon} + (1 - \xi) \frac{p_\mu p_\nu}{(p^2 - i\epsilon)^2} \right). \tag{5.90}$$

We can see that the propagator gets simplified by choosing  $\xi = 1$  (the FEYNMAN gauge). However, one can leave the parameter  $\xi$  free in any calculation to check if the final results for physical quantities are independent of  $\xi$ .





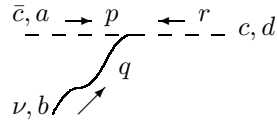

$$-ig(ip_\nu)f_{abd}. \quad (5.99)$$

It is important to note that the sign of the  $c\bar{c}$  propagator and the  $Ac\bar{c}$  vertex is not significant but their relative sign is.

In the Feynman rules cubic vertices are then proportional to a momentum, while the quartic vertices are independent of any momenta. Taking this into account the calculation of the overall degree of divergence  $D$  for a Feynman integral proceeds in essentially the same fashion as that followed before for a scalar theory. The formula is

$$d = 4 - E_A - E_{gh}. \quad (5.100)$$

Note that in the FEYNMAN rules there is a minus sign for ghost loops, which is because they are fermionic, anticommuting fields.

Now one can in principle use these rules to calculate FEYNMAN amplitudes, but the indices make life more difficult; calculations become more difficult practically.

## 5.6 Canonical Approach

Although the functional integral is fine for deriving FEYNMAN rules for gauge theories it is necessary, in order to construct operators and the associated HILBERT space, to consider the canonical approach to quantisation involving dynamical variables and their associated conjugate momenta which are then promoted to operators. As a digression we outline how this proceeds.

With the linear covariant gauge the full quantum Lagrangian density can be expressed just in terms of the fields and their first derivatives in the form

$$\mathcal{L}_q = -\frac{1}{4}F^{\mu\nu} \cdot F_{\mu\nu} - \partial^\mu b \cdot A_\mu + \frac{1}{2}\xi b \cdot b - \partial^\mu \bar{c} \cdot D_\mu c. \quad (5.101)$$

In this case if we were to consider this as a starting point for canonical approach to quantisation, we would find

$$\frac{\partial \mathcal{L}_q}{\partial \dot{A}_i} = -F^{0i}, \quad \frac{\partial \mathcal{L}_q}{\partial \dot{b}} = -A^0, \quad \frac{\partial \mathcal{L}_q}{\partial \dot{\bar{c}}} = \partial^0 \bar{c} = -\dot{\bar{c}}, \quad \frac{\partial \mathcal{L}_q}{\partial \dot{c}} = -D^0 c. \quad (5.102)$$

Hence  $A_i, F_{0i}$  and  $b, A_0$  and  $c, -\partial_0 \bar{c}$  form conjugate pairs like  $q^i, p_i$  so that we may impose on the associated operators canonical commutation, or anti-commutation, relations at equal times,

$$\begin{aligned} [\hat{A}_i(x), \hat{F}^{0i}(0)]_{\text{e.t.}} &= -i\delta^{d-1}(\mathbf{x}), & [\hat{b}(x), \hat{A}^0(0)]_{\text{e.t.}} &= -i\delta^{d-1}(\mathbf{x}), \\ \{D^0 \hat{c}(x), \hat{c}(0)\}_{\text{e.t.}} &= i\delta^{d-1}(\mathbf{x}), & \{\partial^0 \hat{c}(x), \hat{c}(0)\}_{\text{e.t.}} &= -i\delta^{d-1}(\mathbf{x}). \end{aligned} \quad (5.103)$$

For simplicity if we consider the free theory, when  $F_{\mu\nu} \rightarrow \partial_\mu A_\nu - \partial_\nu A_\mu$ ,  $D_\mu c \rightarrow \partial_\mu c$ , which is a starting point for a perturbative treatment. The associated FOCK space of states is also the space on which operator fields are initially defined. In this case the equations of motion require

$$\partial^\mu F_{\mu\nu} - \partial_\nu b = 0, \quad \partial^\mu A_\mu + \xi b = 0, \quad \partial^2 c = 0, \quad \partial^2 \bar{c} = 0. \quad (5.104)$$

These also require

$$\partial^2 A_\nu = (1 - \xi) \partial_\nu b, \quad \partial^2 b = 0. \quad (5.105)$$

The operator fields then satisfy

$$\begin{aligned} [\hat{A}_\mu(x), \hat{A}_\nu(0)] &= -i\eta_{\mu\nu} D(x) \hat{\mathbf{1}} + i(1 - \xi) \partial_\mu \partial_\nu E(x) \hat{\mathbf{1}}, \\ [\hat{A}_\mu(x), \hat{b}(0)] &= -i\partial_\mu D(x) \hat{\mathbf{1}}, \quad [\hat{b}(x), \hat{b}(0)] = 0, \quad \{\hat{c}(x), \hat{c}(0)\} = -iD(x) \hat{\mathbf{1}}. \end{aligned} \quad (5.106)$$

Here

$$D(x) = \frac{i}{(2\pi)^3} \int \frac{d^{d-1}k}{2|\vec{k}|} (e^{ik \cdot x} - e^{-ik \cdot x})|_{k^0=|\vec{k}|}, \quad \partial^2 E(x) = D(x). \quad (5.107)$$

Since  $\partial^2 D(x) = 0$  the commutation relations are compatible with the free equations of motion and also, since  $\partial_t D(x)|_{t=0} = \delta^{d-1}(\vec{x})$ , with the equal time commutation relations.

## 5.7 BRS Symmetry

The quantisation process has introduced additional fields into the theory, so that the space of states necessary after quantisation is now larger than would correspond to the expected physical degrees of freedom. The larger space contains negative norm states and ghost states which violate the spin-statistics theorem. It is vital that we can identify what are the physical states within this space and that these form a HILBERT space with positive norm so that ordinary quantum mechanics is valid.

This is possible because of an additional symmetry, the so-called BRS symmetry<sup>41</sup>, which is related to gauge invariance. BRS symmetry is an extension of the gauge symmetry for the classical action to the quantum action including additional fields. The LAGRANGE density, choosing a linear gauge fixing  $F(A) = F^\mu A_\mu$  for simplicity becomes

$$\mathcal{L}_q = -\frac{1}{4}F^{\mu\nu}(x) \cdot F_{\mu\nu}(x) + b(x) \cdot F^\mu A_\mu(x) + \frac{1}{2}\xi b(x) \cdot b(x) + \bar{c}(x) \cdot F^\mu D_\mu c(x). \quad (5.108)$$

Clearly only the first term is gauge invariant, where for an infinitesimal gauge transformation

$$\delta A_\mu = D_\mu \lambda \quad \Rightarrow \quad \delta F_{\mu\nu} = [F_{\mu\nu}, \lambda] \quad \Rightarrow \quad \delta(F^{\mu\nu} \cdot F_{\mu\nu}) = 0. \quad (5.109)$$

Although the additional terms present in  $\mathcal{L}_q$  are not gauge invariant, there is a residual symmetry:  $\mathcal{L}_q$  is invariant under *BRS symmetry*. To exhibit this we define an operator  $s$  acting on the fields  $A_\mu, c, \bar{c}$  and  $b$ , that relates BOSONS and FERMIONS<sup>42</sup>:

$$\begin{aligned} sA_\mu &= D_\mu c = \partial_\mu c + [A_\mu, c], \\ sc &= -\frac{1}{2}[c, c], \end{aligned}$$

where  $[c, c]_a = f_{abc}c_b c_c$  is non-zero because  $c_b c_c = -c_c c_b$ . What is non trivial is that  $s$  is nilpotent  $s^2 = 0$ . The action of  $s$  anti-commutes with FERMION fields so that

$$s(cX) = (sc)X - csX, \quad (5.111)$$

and similarly for  $\bar{c}$ . To prove  $s^2 = 0$  we verify first

$$s^2 A_\mu = -D_\mu \frac{1}{2}[c, c] + [D_\mu c, c] = 0, \quad (5.112)$$

as a consequence of

$$D_\mu [X, Y] = [D_\mu X, Y] + [X, D_\mu Y], \quad (5.113)$$

and furthermore

$$[c, D_\mu c] = [D_\mu c, c], \quad (5.114)$$

since  $[c, D_\mu c]_a = f_{abc}c_b(D_\mu c)_c = f_{acb}(D_\mu c)_c c_b = [D_\mu c, c]_a$  for anticommuting fields (whereas for BOSONIC fields  $[X, Y] = -[Y, X]$ , of course). Secondly

$$s^2 c = \frac{1}{4}[[c, c], c] - \frac{1}{4}[c, [c, c]] = -\frac{1}{2}[c, [c, c]] = 0, \quad (5.115)$$

because

$$[c, [c, c]]_e = f_{cde}c_c [c, c]_d = f_{cde}f_{abd}c_c c_a c_b = f_{cde}f_{abd}c [c c_a c_b] = 0, \quad (5.116)$$

by the JACOBI identity

$$f_{de}[c f_{ab}]_d = 0. \quad (5.117)$$

We can extend  $s$  to the other fields by defining

$$s\bar{c} = -b, \quad sb = 0, \quad (5.118)$$

<sup>41</sup>Named after Carlo M. Becchi, Alain Rouet, Raymond Stora, who came up with it; sometimes referred to as BRST symmetry because of a Russian, Igor Viktorovich Tyutin (1940-), who was supposed to have also developed the concept, but his paper was never published, an English version has now appeared in arXiv:0812.0580.

<sup>42</sup>So it is reminiscent of supersymmetry, which was discovered slightly earlier, although that relates physical particles.

and acting on these fields it is trivial to see that  $s^2 = 0$ . Thus we have defined the action of  $s$  on the basic fields  $(A_\mu, c, \bar{c}, b)$  so that in general

$$\boxed{s^2 = 0.} \quad (5.119)$$

With this choice the quantum LAGRANGE density in linear gauges can then be written in the form

$$\mathcal{L}_q = -\frac{1}{4}F^{\mu\nu}(x) \cdot F_{\mu\nu}(x) - s\Psi(x), \quad \Psi(x) = \bar{c}(x) \cdot F^\mu A_\mu(x) + \frac{1}{2}\xi \bar{c}(x) \cdot b(x), \quad (5.120)$$

as is easy to see:

$$s\Psi(x) = -b(x) \cdot F^\mu A_\mu(x) - \bar{c}(x) \cdot F^\mu D_\mu c(x) - \frac{1}{2}\xi b(x) \cdot b(x), \quad (5.121)$$

using that  $s$  anticommutes with  $c, \bar{c}$ . The first classical term in  $\mathcal{L}_q$  is gauge invariant since  $sA_\mu = D_\mu c$  is just a infinitesimal gauge transformation, albeit with  $c$  a Grassmann element of the LIE algebra. Since  $s^2 = 0$  we have the important property

$$s\mathcal{L}_q = 0. \quad (5.122)$$

In mathematics with an operation  $s$  acting on some vector space, or ring (where elements can be multiplied as well as added), such that  $s^2 = 0$  then one sets up the cohomology of  $s$  on this space by considering all elements  $\{X\}$  such that  $sX = 0$ . These elements are called *closed*. If  $X = sY$  then  $X$  is trivially closed and elements of this form are *exact*. There is an equivalence relation for closed elements such that  $X \sim X'$  if  $X - X'$  is exact, i.e.  $X - X' = sY$  for some  $Y$ . The cohomology class defined by  $s$  is defined by  $\{X : sX = 0, X \sim X + sY\}$ . Thus  $\mathcal{L}_q$  is exact under the BRS transformation  $s$  and belongs to the same equivalence class as the classical  $\mathcal{L}$ .

The BRS transformation can be used to construct a symmetry under which  $\mathcal{L}$  is invariant by defining

$$\delta_\epsilon(A_\mu, c, b, \bar{c}) = \epsilon s(A_\mu, c, b, \bar{c}), \quad (5.123)$$

where  $\epsilon$  is a GRASSMANN parameter. It is easy to see that  $\delta_\epsilon \mathcal{L}_q = 0$  and also  $\delta_\epsilon^2 = 0$ . Another relevant symmetry of  $\mathcal{L}_q$  is obtained by the transformations

$$\delta_\theta c = \theta c, \quad \delta_\theta \bar{c} = -\theta \bar{c}, \quad (5.124)$$

since  $c$  occurs only in association with  $\bar{c}$  and where we take into account that  $c, \bar{c}$  are regarded as real fields. These transformations on the ghost fields generate a one dimensional symmetry group which leads to conservation of ghost number.

We apply NOETHER's theorem for the BRS transformations  $\delta_\epsilon$  and also for the the  $\delta_\theta$  transformations on  $c, \bar{c}$ . For simplicity we assume here the linear covariant gauge and write  $\mathcal{L}_q$  in a form where there are only first derivatives of the fields

$$\mathcal{L}_q = -\frac{1}{4}F^{\mu\nu} \cdot F_{\mu\nu} - \partial^\mu b \cdot A_\mu - \partial^\mu \bar{c} \cdot D_\mu c + \frac{1}{2}\xi b \cdot b. \quad (5.125)$$

For  $\epsilon(x)$  depending on  $x$  the terms involving derivatives come from

$$\delta_\epsilon D_\mu c = -\partial_\mu \epsilon \frac{1}{2}[c, c], \quad \delta_\epsilon \partial_\mu \bar{c} = -\partial_\mu \epsilon b - \epsilon \partial_\mu b, \quad (5.126)$$

and

$$\delta_\epsilon F_{\mu\nu} = D_\mu \delta_\epsilon A_\nu - D_\nu \delta_\epsilon A_\mu = \partial_\mu \epsilon D_\nu c - \partial_\nu \epsilon D_\mu c + \epsilon [F_{\mu\nu}, c]. \quad (5.127)$$

In calculating  $\delta_\epsilon \mathcal{L}_q$  the  $\epsilon$  terms without derivatives sum up to zero so the relevant answer becomes

$$\delta_\epsilon \mathcal{L}_q = \partial_\mu \epsilon \left( -F^{\mu\nu} \cdot D_\nu c + b \cdot D^\mu c - \partial^\mu \bar{c} \cdot \frac{1}{2}[c, c] \right). \quad (5.128)$$

This gives the *BRS current*

$$j_{\text{BRS}}^\mu = F^{\mu\nu} \cdot D_\nu c - b \cdot D^\mu c + \partial^\mu \bar{c} \cdot \frac{1}{2}[c, c]. \quad (5.129)$$

In a similar fashion letting  $\theta(x)$  depend on  $x$

$$\delta_\theta \mathcal{L}_q = -\partial_\mu \theta (\partial^\mu \bar{c} \cdot c - \bar{c} \cdot D^\mu c), \quad (5.130)$$

so the corresponding *ghost current* is

$$j_{\text{gh}}^\mu = \partial^\mu \bar{c} \cdot c - \bar{c} \cdot D^\mu c. \quad (5.131)$$

These results lead to a conserved quantities, the *BRS charge* and the *ghost charge*

$$Q_{\text{BRS}} = \int d^{d-1}x j_{\text{BRS}}^0(x), \quad Q_{\text{gh}} = \int d^{d-1}x j_{\text{gh}}^0(x). \quad (5.132)$$

In the quantum field theory the fields become operators acting on a HILBERT space  $\mathcal{H}$  which can be generated by the action of the fields on the vacuum  $|0\rangle$ . We require that  $\hat{A}_{\mu\alpha}^\dagger = \hat{A}_{\mu\alpha}$ ,  $\hat{c}_a^\dagger = \hat{c}_a$ ,  $\hat{\bar{c}}_a^\dagger = -\hat{\bar{c}}_a$  (note that with  $A_{\mu\alpha} = A_{\mu\alpha}^*$ ,  $c_a = c_a^*$ ,  $\bar{c}_a = -\bar{c}_a^*$ ,  $b_a = b_a^*$  then  $\mathcal{L}_q = \mathcal{L}_q^*$ ) and then there are HERMITIAN BRS and ghost charges

$$\hat{Q}_{\text{BRS}} = \hat{Q}_{\text{BRS}}^\dagger, \quad \hat{Q}_{\text{gh}} = \hat{Q}_{\text{gh}}^\dagger. \quad (5.133)$$

We must then have

$$[\hat{Q}_{\text{gh}}, \hat{c}] = i\hat{c}, \quad [\hat{Q}_{\text{gh}}, \hat{\bar{c}}] = -i\hat{\bar{c}}, \quad (5.134)$$

and, for  $\epsilon$  anti-commuting,

$$[\epsilon \hat{Q}_{\text{BRS}}, X] = i\delta_\epsilon X. \quad (5.135)$$

It is crucial that the BRS charge satisfies

$$\hat{Q}_{\text{BRS}}^2 = 0, \quad (5.136)$$

corresponding to  $s^2 = 0$  and, since  $\hat{Q}_{\text{BRS}}$  increases the ghost charge by one,

$$[\hat{Q}_{\text{gh}}, \hat{Q}_{\text{BRS}}] = i\hat{Q}_{\text{BRS}}. \quad (5.137)$$

Since these are conserved we must have

$$[\hat{H}, \hat{Q}_{\text{BRS}}] = 0, \quad [\hat{H}, \hat{Q}_{\text{gh}}] = 0. \quad (5.138)$$

The aim now is to define the physical space of states. The initial HILBERT space  $\mathcal{H}$  has negative and zero norm states, otherwise nilpotent operators like  $\hat{Q}_{\text{BRS}}$  would be trivial. If you quantise a gauge theory in a LORENTZ invariant fashion negative norm states are essentially inevitable. The essential assumption is that physical states correspond to the cohomology classes defined by  $\hat{Q}_{\text{BRS}}$ .

First define the subspace  $\mathcal{H}_0 \subset \mathcal{H}$  by

$$\hat{Q}_{\text{BRS}}|\psi\rangle = 0 \quad \forall \quad |\psi\rangle \in \mathcal{H}_0. \quad (5.139)$$

Clearly this is a subspace because  $\mathcal{H}_0$  is the kernel of  $\hat{Q}_{\text{BRS}}$ . Since  $\hat{Q}_{\text{BRS}}$  is conserved the space  $\mathcal{H}_0$  is invariant under time evolution. The essential assumption is that  $\mathcal{H}_0$  is positive semi-definite or

$$\langle\psi|\psi\rangle \geq 0 \quad \forall \quad |\psi\rangle \in \mathcal{H}_0. \quad (5.140)$$

For any positive semi-definite space a proper HILBERT space can be defined by considering equivalence classes

$$|\psi\rangle \sim |\psi'\rangle \quad \text{if} \quad |\psi'\rangle - |\psi\rangle = |\phi\rangle, \quad \langle\phi|\phi\rangle = 0. \quad (5.141)$$

By this construction if  $\langle\psi|\psi\rangle = 0$  then  $|\psi\rangle \sim 0$ . Note that if the space is positive semi-definite then if  $|\phi\rangle$  is a zero norm state and  $|\psi\rangle$  is any state we must have  $\langle\phi|\psi\rangle = 0$ , otherwise  $|\psi\rangle + \alpha|\phi\rangle$  has negative norm for some  $\alpha$ . Hence the zero norm states form a subspace and furthermore it is then easy to verify that

$$\langle\psi_1|\psi_2\rangle = \langle\psi'_1|\psi'_2\rangle \quad \text{if} \quad |\psi'_1\rangle \sim |\psi_1\rangle, \quad |\psi'_2\rangle \sim |\psi_2\rangle. \quad (5.142)$$

So the identification of equivalent states is a well-defined operation which preserves scalar products. This then gives a prescription for defining the space of physical states  $\mathcal{H}_{\text{phys}} = \mathcal{H}_0 / \sim$  which satisfies the usual requirements of quantum mechanics. A further assumption is that the zero norm states are BRS exact, i.e.

$$\langle \phi | \phi \rangle = 0 \quad \Rightarrow \quad |\phi\rangle = \hat{Q}_{\text{BRS}} |\lambda\rangle \quad \text{for some } |\lambda\rangle. \quad (5.143)$$

This ensures that  $\mathcal{H}_{\text{phys}}$  is formed by the cohomology classes of  $\hat{Q}_{\text{BRS}}$  acting on the original space  $\mathcal{H}$ .

A further restriction is to consider just states with zero ghost number i.e.

$$\hat{Q}_{\text{gh}} |\psi\rangle = 0, \quad (5.144)$$

since physical states should satisfy this condition. Generally states with non zero ghost number are BRS exact so they do not belong to  $\mathcal{H}_{\text{phys}}$ .

We now verify how this works for the subspace of single particle states. The field  $b$  can always be eliminated, so we do not have to consider a corresponding single particle state since  $|b(k)\rangle \propto k^\mu |A_\mu(k)\rangle$ . The set of single particle states is spanned by

$$|A_\mu(k)\rangle, \quad |c(k)\rangle, \quad |\bar{c}(k)\rangle. \quad (5.145)$$

The action of  $\hat{Q}_{\text{BRS}}$  on these states is determined by the linear terms in the corresponding action on the fields and must be of the form

$$\hat{Q}_{\text{BRS}} |A_\mu(k)\rangle = \alpha k_\mu |c(k)\rangle, \quad (5.146a)$$

$$\hat{Q}_{\text{BRS}} |c(k)\rangle = 0, \quad (5.146b)$$

$$\hat{Q}_{\text{BRS}} |\bar{c}(k)\rangle = \beta k^\mu |A_\mu(k)\rangle, \quad (5.146c)$$

for some  $\alpha$  and  $\beta$ , using that  $\hat{Q}_{\text{BRS}}$  increases the ghost charge by one, requiring LORENTZ invariance and furthermore assuming that  $\hat{Q}_{\text{BRS}}$  maps single particle states to single particle states. Clearly

$$\hat{Q}_{\text{BRS}}^2 |\bar{c}(k)\rangle = 0 \quad \Rightarrow \quad k^2 = 0. \quad (5.147)$$

The action of the ghost number operator  $\hat{Q}_{\text{gh}}$ , which counts the number of ghost fields, is also given by

$$\hat{Q}_{\text{gh}} |c_a(k)\rangle = i |c_a(k)\rangle, \quad \hat{Q}_{\text{gh}} |\bar{c}_a(k)\rangle = -i |\bar{c}_a(k)\rangle, \quad (5.148a)$$

$$\langle c_a(k) | \hat{Q}_{\text{gh}} = -i \langle c_a(k) |, \quad \langle \bar{c}_a(k) | \hat{Q}_{\text{gh}} = i \langle \bar{c}_a(k) |. \quad (5.148b)$$

It is an interesting exercise to verify that  $\hat{Q}_{\text{gh}}$ , although it has imaginary eigenvalues, is an HERMITIAN operator. The ghost number may be defined as the integer eigenvalue of  $i\hat{Q}_{\text{gh}}$ .

The scalar products which are determined by the propagators for the fields and must be consistent with  $\hat{Q}_{\text{BRS}}, \hat{Q}_{\text{gh}}$  being hermitian. We assume a LORENTZ invariant formalism as appropriate for a linear covariant gauge, which requires that these single particle states have the normalisation

$$\langle A_{\mu a}(k') | A_{\nu b}(k) \rangle = \eta_{\mu\nu} \delta_{ab} \delta_{k'k}, \quad \delta_{k'k} := (2\pi)^{d-1} 2k^0 \delta^{d-1}(\vec{k} - \vec{k}'), \quad (5.149)$$

which yields negative norm for timelike components since  $\eta_{00} = -1$ , and, for the ghost fields,

$$\langle \bar{c}_a(k') | c_b(k) \rangle = \delta_{ab} \delta_{k'k}. \quad (5.150)$$

All other single particle scalar products are zero, in particular

$$\langle c_a(k') | c_b(k) \rangle = 0, \quad (5.151)$$

so  $|c_a(k)\rangle$  is a zero norm state. By considering  $\langle \bar{c}^*(k') | \hat{Q}_{\text{BRS}} |A_\mu(k)\rangle$  we must have  $\beta = \alpha^*$ .

To obtain a consistent physical theory it is necessary to reduce the theory from one defined on space of states including those with negative norm  $\mathcal{H}$  to a space of physical states which have

positive norm.  $\mathcal{H}_{\text{phys}}$ , the physical HILBERT<sup>43</sup> space, must contain only positive norm states and it must also be invariant under time evolution. Since  $\mathcal{H}_{\text{phys}}$  has to be defined in terms of  $\mathcal{H}$  then this definition must not depend on how it is set up at any initial time.

The subspace of  $\mathcal{H}_0$  formed by single particle states that are annihilated by  $\hat{Q}_{BRS}$  is then determined by the basis

$$\epsilon^\mu |A_\mu(k)\rangle, \quad \epsilon \cdot k = 0, \quad |c(k)\rangle. \quad (5.152)$$

With the equivalence

$$|\psi\rangle \sim |\psi\rangle + \hat{Q}_{BRS}|\phi\rangle, \quad (5.153)$$

we must have

$$\epsilon^\mu |A_\mu(k)\rangle \sim (\epsilon^\mu + \lambda k^\mu) |A_\mu(k)\rangle, \quad |c\rangle \sim 0. \quad (5.154)$$

Hence  $\mathcal{H}_{\text{phys}}$  just consists of all states  $\epsilon^\mu |A_\mu(k)\rangle$ , subject to

$$\epsilon \cdot k = 0, \quad \epsilon^\mu \sim \epsilon^\mu + \lambda k^\mu. \quad (5.155)$$

Note that in  $d$ -dimensions, both of these conditions remove one degree of freedom, so that  $\epsilon$  has just  $d - 2$  degrees of freedom. The physical states here just have zero ghost number.

Let us check the norm of these states:

$$\epsilon^{*\mu} \langle A_\mu(k) | A_\nu(k') \rangle \epsilon^\nu = \epsilon^* \cdot \epsilon \delta_{kk'}, \quad (5.156)$$

where  $\delta_{kk'}$  is the standard KRONECKER<sup>44</sup> delta, as far as the momentum is concerned. Note that

$$\epsilon^* \cdot \epsilon = -|\epsilon_0|^2 + |\vec{\epsilon}|^2, \quad (5.157)$$

and also

$$0 = \epsilon \cdot k = \epsilon^0 k_0 + \vec{\epsilon} \cdot \vec{k} = -\epsilon^0 |\vec{k}| + \vec{\epsilon} \cdot \vec{k}, \quad (5.158)$$

so that

$$\epsilon^* \cdot \epsilon = |\vec{\epsilon}|^2 - \frac{1}{|\vec{k}|^2} |\vec{\epsilon} \cdot \vec{k}|^2 \geq 0. \quad (5.159)$$

This is zero only for  $\vec{\epsilon} \propto \vec{k}$  and then  $\epsilon^\mu \propto k^\mu$ , and for these states the equivalence implies

$$\epsilon^\mu |A_\mu(k)\rangle \sim 0. \quad (5.160)$$

## 5.8 Renormalisation of Gauge Theories

Gauge theories are renormalisable, with the degree of divergence given by

$$d = 4 - E_A - E_{\text{gh}}, \quad (5.161)$$

where  $E_A$  and  $E_{\text{gh}}$  denotes the number of external gauge and ghost lines, respectively. Any FEYNMAN diagram with  $D \geq 0$  is expected to generate divergences that have to be cancelled. The requirement of renormalisability is that

$$\langle \dots A_\mu(x) \dots c(y) \dots \bar{c}(z) \dots b(w) \dots \rangle, \quad (5.162)$$

can be made finite, for arbitrary numbers of field, by adding counterterms to the original LAGRANGIAN,

$$\mathcal{L} \rightarrow \mathcal{L} + \mathcal{L}_{\text{c.t.}}, \quad (5.163)$$

in a fashion similar to previously. What counterterms are necessary is determined by  $D$  and also by the form chosen for the gauge fixing term. For the LORENTZ invariant linear gauge  $F(A) = \partial^\mu A_\mu$  and using dimensional regularisation  $\mathcal{L}_{\text{c.t.}}$  contains all contributions formed from local functions of the fields and their derivatives of dimension four, with the following requirements:

<sup>43</sup>Hilbert, David (1862-1943)

<sup>44</sup>Kronecker, Leopold (1823-1891)

- (i) LORENTZ invariance,
- (ii) BRS invariance,
- (iii) conservation of ghost number.

Because of requirement (iii) each diagram has a  $\bar{c}$  external line for every external  $c$  line so that  $E_{\text{gh}}$  must be even. The crucial cases for which  $D \geq 0$  are then for  $E_A = 2, 3, 4$ ,  $E_{\text{gh}} = 0$  ( $E_A = 1$  is absent because of LORENTZ invariance), which require counterterms involving  $A^2, A^3, A^4$  and  $E_{\text{gh}} = 2$  and  $E_A = 0, 1$ , for which the counterterms involve  $c\bar{c}, c\bar{c}A$ . For the linear covariant gauge the cases  $E_{\text{gh}} = E_A = 2$  and  $E_{\text{gh}} = 4$  do not require corresponding counterterms as when there are ghost lines  $D$  is reduced by one and the associated FEYNMAN integrals do not diverge. This is because the FEYNMAN rules for this simple gauge fixing require that for each  $c\bar{c}A$  vertex the contribution contains just the momentum for the  $\bar{c}$  line at this vertex. For two such vertices which are part of a loop only one of the momentum factors is involved in the loop integration rather than two which would be expected according to the naive power counting rules so the degree of divergence for the loop integral is reduced by one.

It is possible to consider non-LORENTZ invariant or non linear gauge fixing conditions, but in general this makes the renormalisation analysis more complicated. Requirement (i) ensures that all counterterms are LORENTZ scalars.

With  $d = 4 - \varepsilon$  the starting theory is written as

$$\mathcal{L}_q = \mu^{-\varepsilon} \frac{1}{g^2} \left( -\frac{1}{4} F^{\mu\nu}(gA) \cdot F_{\mu\nu}(gA) - s \Psi(gA, g\bar{c}, gb) \right), \quad (5.164)$$

where we define

$$F_{\mu\nu}(A) = \partial_\mu A_\nu - \partial_\nu A_\mu + [A_\mu, A_\nu], \quad \Psi(A, \bar{c}, b) = \bar{c} \cdot \partial^\mu A_\mu + \frac{1}{2} \xi \bar{c} \cdot b, \quad (5.165)$$

and now, because of the rescaling of the fields by  $g$ ,

$$sA_\mu = D_\mu(gA)c = \partial_\mu c + g[A_\mu, c], \quad sc = -\frac{1}{2}g[c, c], \quad s\bar{c} = -b, \quad sb = 0. \quad (5.166)$$

The overall factor  $\mu^{-\varepsilon}$ , involving an arbitrary mass scale  $\mu$ , has been introduced to ensure  $\mathcal{L}_q$  has dimension  $d$  while  $A_\mu, c, \bar{c}$  have dimension 1,  $b$  dimension 2 while  $g$  is dimensionless. Furthermore the fields have been rescaled by  $g$  to ensure that the quadratic terms are independent of  $g$ . As has been discussed this is invariant under BRS transformations  $s\mathcal{L}_q = 0$ .

The counterterms also have to be compatible with BRS symmetry. This is fundamental since the whole definition of the physical theory in terms of states with positive norm depends on the conserved BRS charge  $\hat{Q}_{BRS}$  as a nilpotent operator. Dimensional regularisation preserves BRS symmetry since it is valid for any  $d$ . To see the implications we define

$$\mathcal{L}_{q,0} = \mathcal{L}_q + \mathcal{L}_{\text{c.t.}}, \quad (5.167)$$

where we must require

$$s\mathcal{L}_{q,0} = 0. \quad (5.168)$$

However although we must have  $s^2 = 0$  the action of  $s$  on the fields may be modified.  $\mathcal{L}_{q,0}$  contains various divergent constants, corresponding to poles in  $\varepsilon$ , which are traditionally labelled  $Z$ . When  $Z = 1$  in each case  $\mathcal{L}_{q,0}$  reduces to  $\mathcal{L}_q$ . In general for each  $Z$  there is an expansion

$$Z = 1 + \sum_{n=1}^{\infty} \frac{z_n(g, \xi)}{\varepsilon^n}, \quad (5.169)$$

where the  $\varepsilon$  poles generate the necessary counterterms. The claim is that it is sufficient in order to get a finite result for Feynman integrals to any order to take

$$\mathcal{L}_{q,0} = \mu^{-\varepsilon} \left( -\frac{Zg}{4g^2} F^{\mu\nu}(gZ_\alpha A) \cdot F_{\mu\nu}(gZ_\alpha A) + Z_\beta \bar{c} \cdot \partial^\mu D_\mu(gZ_\alpha A)c + b \cdot \partial^\mu A_\mu + \frac{1}{2} \xi b \cdot b \right), \quad (5.170)$$

for suitable  $Z_g, Z_\alpha, Z_\beta$ . In this expression for  $\mathcal{L}_{q,0}$  we have assumed there are no divergences associated with the  $b$  field, it only contributes to one-particle reducible diagrams which do not require separate counterterms to ensure finiteness; hence there are no  $Z$  factors in the terms  $b^2$  and  $b\partial A$ . The action of  $s$  is modified to ensure  $s\mathcal{L}_{q,0} = 0$  and also  $s^2 = 0$ ,

$$sA_\mu = D_\mu(gZ_\alpha A)c, \quad sc = -\frac{1}{2}gZ_\alpha [c, c], \quad s\bar{c} = -\frac{1}{Z_\beta} b, \quad sb = 0. \quad (5.171)$$

In consequence *BRS* symmetry remains valid for the finite theory obtained after regularisation since

$$\mathcal{L}_{q,0} = \mu^{-\varepsilon} \left( -\frac{Z_g}{4g^2} F^{\mu\nu}(gZ_\alpha A) \cdot F_{\mu\nu}(gZ_\alpha A) - Z_\beta s\Psi(A, \bar{c}, b) \right). \quad (5.172)$$

In  $\mathcal{L}_{q,0}$   $b$  can be eliminated by setting  $b = -\partial^\mu A_\mu/\xi$ . It is important to note that there just three  $Z$ 's present in  $\mathcal{L}_{q,0}$  which can be used to cancel divergencies whereas there are five different cases for different numbers of external  $A$  and ghost lines for which there are divergent graphs. Also the form of the counterterms which are contained in  $\mathcal{L}_{q,0}$  are not the most general Lorentz invariant expressions either. Thus *BRS* invariance must constrain the different divergencies in order for them to be cancelled by the allowed counterterms. Now let us illustrate, without doing any calculations of Feynman integrals, how this works out at one loop. The results are expressed in terms of the group theory constant  $C$  defined by

$$f_{acd}f_{bcd} = C\delta_{ab}, \quad (5.173)$$

where for  $SU(N)$   $C = N$ .

For  $E_A = 2$  and no external ghosts  $\mathcal{L}_{q,0,AA} = -\mu^{-\varepsilon} \frac{1}{2} (Z_g Z_\alpha^2 \partial^\mu A^\nu \cdot (\partial_\mu A_\nu - \partial_\nu A_\mu) + \partial^\mu A_\mu \cdot \partial^\nu A_\nu/\xi)$ . The one loop graphs are

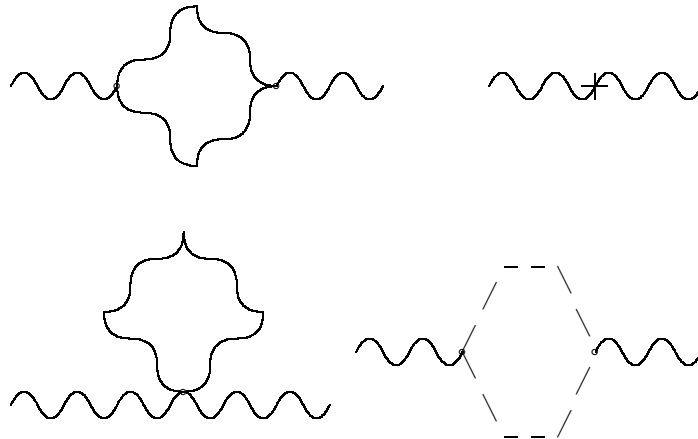

We obtain the result

$$Z_g Z_\alpha^2 = 1 + \frac{g^2 C}{16\pi^2} \left( \frac{5}{3} + \frac{1}{2}(1 - \xi) \right) \frac{2}{\varepsilon}, \quad (5.174)$$

where  $C$  is some group constant, which is equal to  $N$  for  $SU(N)$ .

For  $E_A = 3$   $\mathcal{L}_{q,0,AAA} = -\mu^{-\varepsilon} Z_g Z_\alpha^3 \partial^\mu A^\nu \cdot [A_\mu, A_\nu]$ . The one loop graphs are

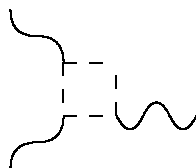



These give

$$Z_g Z_\alpha^3 = 1 + \frac{g^2 C}{16\pi^2} \left( \frac{2}{3} + \frac{3}{4}(1-\xi) \right) \frac{2}{\varepsilon}. \quad (5.175)$$

For  $E_A = 4$   $\mathcal{L}_{q,0,AAAA} = -\mu^{-\varepsilon} \frac{1}{4} Z_g Z_\alpha^4 [A^\mu, A^\nu] \cdot [A_\mu, A_\nu]$  and we have the one loop diagrams

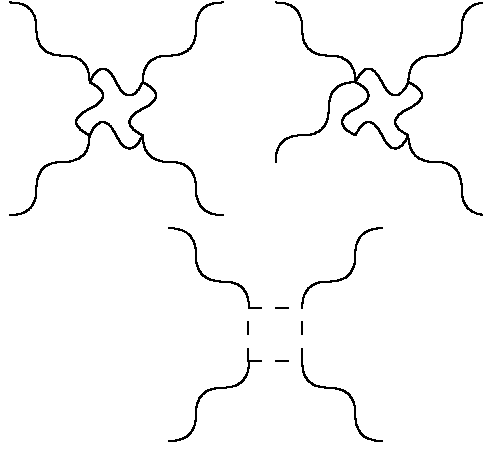

These contribute

$$Z_g Z_\alpha^4 = 1 + \frac{g^2 C}{16\pi^2} \left( -\frac{1}{3} + (1-\xi) \right) \frac{2}{\varepsilon}. \quad (5.176)$$

For two external ghost lines  $E_{\text{gh}} = 2$ ,  $E_A = 0$   $\mathcal{L}_{q,0,\bar{c}c} = \mu^{-\varepsilon} Z_\beta \bar{c} \cdot \partial^2 c$ . We get

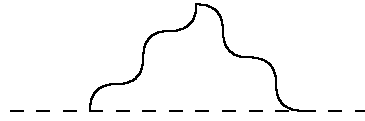

$$Z_\beta = 1 + \frac{g^2 C}{16\pi^2} \left( \frac{1}{2} + \frac{1}{4}(1-\xi) \right) \frac{2}{\varepsilon}. \quad (5.177)$$

Finally for  $E_{\text{gh}} = 2$ ,  $E_A = 1$   $\mathcal{L}_{q,0,\bar{c}cA} = \mu^{-\varepsilon} Z_\beta Z_\alpha \bar{c} \cdot \partial^\mu [A_\mu, c]$ . We get in this case

$$Z_\beta Z_\alpha = 1 + \frac{g^2 C}{16\pi^2} \left( -\frac{1}{2} + \frac{1}{2}(1-\xi) \right) \frac{2}{\varepsilon}. \quad (5.178)$$

These give five independent results for three quantities, one can use this to check for consistency and obtain the result

$$Z_\alpha = 1 + \frac{g^2 C}{16\pi^2} \left( -1 + \frac{1}{4}(1-\xi) \right) \frac{2}{\varepsilon}, \quad (5.179)$$

and also

$$\boxed{Z_g = 1 + \frac{g^2 C}{16\pi^2} \cdot \frac{11}{3} \cdot \frac{2}{\varepsilon}}. \quad (5.180)$$

This is a very important result;  $Z_g$  is independent of  $\xi$ .

The LAGRANGIAN  $\mathcal{L}_{q,0}$  including counterterms is the bare LAGRANGIAN and can be written in terms of bare fields and couplings in the form

$$\mathcal{L}_{q,0} = -\frac{1}{4g_0^2} F^{\mu\nu}(g_0 A_0) \cdot F_{\mu\nu}(g_0 A_0) + \bar{c}_0 \cdot \partial^\mu D_\mu(g_0 A_0) c_0 + b_0 \cdot \partial^\mu A_{0\mu} + \frac{1}{2} \xi_0 b_0 \cdot b_0, \quad (5.181)$$

where we define

$$g_0^2 = \frac{g^2}{Z_g} \mu^\varepsilon, \quad \xi_0 = Z_g Z_\alpha^2 \xi, \quad (5.182)$$

and also for the bare fields

$$A_0 = \mu^{-\frac{\epsilon}{2}} \sqrt{Z_g} Z_\alpha A, \quad c_0 = \mu^{-\frac{\epsilon}{2}} \sqrt{Z_g} Z_\alpha c, \quad \bar{c}_0 = \mu^{-\frac{\epsilon}{2}} \frac{Z_\beta}{\sqrt{Z_g} Z_\alpha} \bar{c}, \quad b_0 = \mu^{-\frac{\epsilon}{2}} \frac{1}{\sqrt{Z_g} Z_\alpha} b. \quad (5.183)$$

The definition of  $c_0, \bar{c}_0$  is somewhat arbitrary since we may have  $c_0 \rightarrow \lambda c_0$  while  $\bar{c}_0 \rightarrow \bar{c}_0/\lambda$ . With the above choice then the action of  $s$  in terms of the bare fields becomes

$$s c_0 = -\frac{1}{2} g_0 [c_0, c_0], \quad s A_{0\mu} = D_\mu (g_0 A_0) c_0, \quad s \bar{c}_0 = -b_0, \quad s b_0 = 0, \quad (5.184)$$

which is the essentially the same as before, and

$$\mathcal{L}_{g,0} = -\frac{1}{4g_0^2} F^{\mu\nu}(g_0 A_0) \cdot F_{\mu\nu}(g_0 A_0) - s_0 \Psi_0(A_0, \bar{c}_0, b_0), \quad \Psi_0(A_0, \bar{c}_0, b_0) = \bar{c}_0 \cdot \partial^\mu A_{0\mu} + \frac{1}{2} \xi_0 \bar{c}_0 \cdot b_0. \quad (5.185)$$

From the one loop result for  $Z_g$

$$\frac{1}{g_0^2} = \mu^{-\epsilon} \left( \frac{1}{g^2} + \frac{C}{16\pi^2} \cdot \frac{11}{3} \cdot \frac{2}{\epsilon} \right). \quad (5.186)$$

Now if you follow the procedures described earlier the  $\beta$ -function is defined by

$$\mu \frac{dg}{d\mu} \Big|_{g_0} = -\frac{1}{2} \epsilon g + \beta(g). \quad (5.187)$$

Differentiating  $g_0^{-2}$  with respect to  $\mu$  then gives

$$\epsilon \left( \frac{1}{g^2} + \frac{C}{16\pi^2} \cdot \frac{11}{3} \cdot \frac{2}{\epsilon} \right) = \left( -\frac{1}{2} \epsilon g + \beta(g) \right) \frac{\partial}{\partial g} \frac{1}{g^2}, \quad (5.188)$$

which implies that to this order

$$\boxed{\beta(g) = -\frac{11}{3} \frac{g^3 C}{16\pi^2} < 0.} \quad (5.189)$$

The minus sign indicates asymptotic freedom.

Now of course to calculate these things can be a mess, because the number of indices floating around is quite large, one has to do a lot of contractions, and it is quite a non trivial exercise unless one has previous experience. According to some historical recollections there were some initial confusions as to signs by those who first published a clear result for this calculation of the  $\beta$ -function, GROSS and WILCZEK and separately POLITZER.<sup>45</sup>

### 5.8.1 Calculation of $\beta(g)$ at One Loop

We now describe a more simplified calculation which leads to the same result for  $\beta(g)$  at one loop. The crucial step is to find a way of calculation  $Z_g$  directly without it being in combination with other renormalisation constants which require a separate calculation.

To achieve this the quantum gauge field  $\mathcal{A}_\mu$  is expanded about a fixed classical background  $A_\mu$ , so that

$$\mathcal{A}_\mu = A_\mu + g a_\mu, \quad (5.190)$$

where the functional integral is reduced to one over  $a_\mu$ . In general to obtain a perturbation expansion it is not necessary to expand around zero field; in general relativity, for example, it is usual to expand around the non zero metric for flat space. Note that for the field strength

$$\mathcal{F}_{\mu\nu} = F_{\mu\nu}(\mathcal{A}) = F_{\mu\nu} + g(D_\mu a_\nu - D_\nu a_\mu) + g^2[a_\mu, a_\nu], \quad (5.191)$$

<sup>45</sup>Gross, David Jonathan (1941-), Wilczek, Frank Anthony (1951-), Politzer, Hugh David (1949-), Nobel Prizes 2004

for  $F_{\mu\nu} = F_{\mu\nu}(A)$  and we have defined

$$D_\mu a_\nu = \partial_\mu a_\nu + [A_\mu, a_\nu], \quad (5.192)$$

which is the covariant derivative for the background gauge field  $A_\mu$ .

The initial LAGRANGIAN is

$$\mathcal{L} = -\frac{1}{4g^2} \mathcal{F}^{\mu\nu} \cdot \mathcal{F}_{\mu\nu}, \quad (5.193)$$

which is invariant under gauge transformations on  $\mathcal{A}_\mu$ ,

$$A_\mu \rightarrow \mathcal{A}_\mu^g = g^{-1} A_\mu g + g^{-1} \partial_\mu g, \quad \mathcal{F}_{\mu\nu} \rightarrow \mathcal{F}_{\mu\nu}^g = g^{-1} \mathcal{F}_{\mu\nu} g. \quad (5.194)$$

Because of the split into  $A_\mu$  and  $a_\mu$  this also implies invariance under

$$A_\mu \rightarrow g^{-1} A_\mu g + g^{-1} \partial_\mu g, \quad a_\mu \rightarrow g^{-1} a_\mu g, \quad (5.195)$$

which is called a *background gauge transformation*. We claim that it is possible to maintain background gauge invariance in the full quantum theory although it is still necessary to introduce gauge fixing term. In the functional integral we require

$$d[A] = d[a], \quad d[a] = d[g^{-1} a g]. \quad (5.196)$$

The quantum action, eliminating  $b$ , is then given by

$$\mathcal{L}_q = -\frac{1}{4g^2} \mathcal{F}^{\mu\nu} \cdot \mathcal{F}_{\mu\nu} - \frac{1}{2} F(a) \cdot F(a) + \bar{c} \cdot F'^\mu \mathcal{D}_\mu c, \quad (5.197)$$

where we have set  $\xi = 1$  for convenience.  $F(a)$  is the gauge fixing condition and  $\mathcal{D}_\mu c = D_\mu c + g[a_\mu, c]$ .

That is so far standard, but the crucial idea is that under the background gauge transformation we may choose  $F(a)$  so that it is covariant,  $F(g^{-1} a g) = g^{-1} F(a) g$ , and so  $F(a) \cdot F(a)$  is invariant. To achieve this we take

$$f(a) = D^\mu a_\mu. \quad (5.198)$$

Then  $\mathcal{L}_q$  is invariant under background gauge transformations where the quantum field  $a_\mu$  transforms homogeneously. Nevertheless quantum gauge transformations which act only on the dynamical field  $a_\mu$ , with  $A_\mu$  fixed,

$$a_\mu \rightarrow a_\mu^g = g^{-1} a_\mu g + g^{-1} \partial_\mu g + \frac{1}{g} (g^{-1} A_\mu g - A_\mu), \quad (5.199)$$

and are a symmetry of the classical Lagrangian, are gauge fixed are not a symmetry of  $\mathcal{L}_q$ . Note that this expression for the gauge fixing term reduces to the standard linear covariant choice when  $A_\mu = 0$ .

Defining  $S_q[a, A, c, \bar{c}] = \int d^d x \mathcal{L}_q$  then letting

$$Z[A] = \int d[a] d[c] d[\bar{c}] e^{i S_q[a, A, \bar{c}, c]}, \quad (5.200)$$

we must have  $Z[A] = Z[A^g]$ . We also define

$$Z[A] = e^{i W[A]}. \quad (5.201)$$

Now in order to get a perturbative expansion, we expand  $S_q$  in powers of  $a_\mu$ ; at lowest order, at one loop, it is sufficient to restrict the expansion to just the quadratic terms in  $a_\mu, c, \bar{c}$ . Higher loop calculations involve the cubic and quartic terms as interactions. Hence we write

$$S_q[a, c, \bar{c}] = \frac{1}{g^2} S[A] + \frac{1}{g} \int d^d x D_\mu F^{\mu\nu} \cdot a_\nu + S_a + S_{\text{gh}} + O(a^3, \bar{c} c a), \quad (5.202)$$

where  $S[A]$  is just the basic action for the background field, namely

$$S[A] = -\frac{1}{4} \int d^d x F^{\mu\nu} \cdot F_{\mu\nu}. \quad (5.203)$$

For the quadratic terms it is easy to see what the ghost contribution is,

$$S_{\text{gh}} = \int d^d x \bar{c} \cdot D^2 c, \quad (5.204)$$

where as before  $D_\mu$  is the background covariant derivative. The result for  $S_a$  which is quadratic in  $a$  is more involved. Using the expansion of  $\mathcal{F}_{\mu\nu}$  we get

$$\begin{aligned} S_a &= \frac{1}{2} \int d^d x \left( -D^\mu a^\nu \cdot (D_\mu a_\nu - D_\nu a_\mu) - [a^\mu, a^\nu] \cdot F_{\mu\nu} - D^\nu a_\nu \cdot D^\mu a_\mu \right) \\ &= \frac{1}{2} \int d^d x a^\nu \cdot (D^2 a_\nu - D^\mu D_\nu a_\mu + [F_{\nu\mu}, a^\mu] + D_\nu D^\mu a_\mu), \end{aligned} \quad (5.205)$$

integrating by parts and using  $[a^\mu, a^\nu] \cdot F_{\mu\nu} = a^\nu \cdot [F_{\nu\mu}, a^\mu]$ . Noting also  $[D^\mu, D_\nu] a_\mu = [F^\mu{}_\nu, a_\mu]$  we get

$$\begin{aligned} S_a &= \frac{1}{2} \int d^d x a^\nu \cdot (D^2 a_\nu + 2[F_{\nu\mu}, a^\mu]) \\ &=: -\frac{1}{2} \int d^d x a^\nu \cdot \Delta_\nu{}^\mu a_\mu, \end{aligned} \quad (5.206)$$

where we defined the operator

$$\Delta_\nu{}^\mu = -D^2 \delta_\nu{}^\mu - 2F_{\nu\mu}{}^\alpha T_\alpha, \quad (5.207)$$

where  $T_a$  are the generators of the LIE group in the adjoint representation.

Let us suppose that  $D^\mu F_{\mu\nu} = 0$ , so in this case there is no linear term.<sup>46</sup> Then the one loop approximation is obtained by

$$Z[A] = e^{iW[A]} = e^{\frac{i}{g^2} S[A]} \int d[a]d[c]d[\bar{c}] e^{i(S_a + S_{\text{gh}})}, \quad (5.209)$$

where  $S_a, S_{\text{gh}}$  are just the quadratic terms in the expansion given above. The Gaussian functional integrals are readily evaluated in terms of the determinants of the relevant differential operators, giving

$$Z[A] = e^{\frac{i}{g^2} S[A]} \frac{\det(-D^2)}{(\det \Delta)^{\frac{1}{2}}}, \quad W[A] = \frac{1}{g^2} S[A] + \frac{1}{i} \log \det(-D^2) - \frac{1}{2i} \log \det \Delta. \quad (5.210)$$

It is important to recognise that under background gauge transformations  $D^2 \rightarrow g^{-1} D^2 g$  and  $\Delta \rightarrow g^{-1} \Delta g$  so the determinants are gauge invariant. The determinants may be normalised so that  $\det(-D^2) = \det \Delta = 1$  when  $A_\mu = 0$  so that  $W[0] = 0$ .

The aim is now to calculate the divergent parts, or poles as  $\varepsilon = 4 - d \rightarrow 0$ , of these two determinants. The answers are given by

$$\log \det(-D^2) \sim -\frac{1}{3} \frac{2}{\varepsilon} \frac{C}{16\pi^2} iS[A], \quad \log \det \Delta = \frac{20}{3} \frac{2}{\varepsilon} \frac{C}{16\pi^2} iS[A]. \quad (5.211)$$

The divergent terms can only involve  $S[A]$  since this is the unique gauge invariant quantity of dimension four. The group constant  $C$  is here defined by

$$\text{tr}(T_a T_b) = -C \delta_{ab}. \quad (5.212)$$

<sup>46</sup>Alternatively let

$$e^{iW[A, J]} = \int d[a]d[c]d[\bar{c}] e^{iS_q[a, A, \bar{c}, c] + \int d^d x J^\mu(x) \cdot a_\mu(x)}, \quad (5.208)$$

and eliminate  $J$  by requiring  $\delta W[A, J]/\delta J(x) = 0$ .

Hence the divergent part will then be given by

$$W[A] \sim \frac{1}{g^2} S[A] - \frac{11}{3} \frac{2}{\varepsilon} \frac{C}{16\pi^2} S[A]. \quad (5.213)$$

The  $\varepsilon$  pole can be cancelled by replacing in the first term

$$\frac{1}{g^2} \rightarrow \frac{Z_g}{g^2}, \quad (5.214)$$

and then letting

$$Z_g = 1 + \frac{11}{3} \frac{2}{\varepsilon} \frac{Cg^2}{16\pi^2}. \quad (5.215)$$

This is of course the same as previously, this gives directly the one loop result for  $\beta(g)$  with the correct sign for asymptotic freedom.

In order to calculate the divergent parts of the determinants of the differential operators depending on the background field  $A_\mu$  it is possible to use methods which maintain gauge covariance throughout and are valid for any smooth background. This would require some digression so instead we do it by brute force, expanding in the background field  $A_\mu$  to quadratic order. This is sufficient to determine the coefficient of the  $\varepsilon$  poles which are proportional to  $S[A]$  and reduces the calculation to that for one loop FEYNMAN integrals.

First we consider  $\det(-D^2)$ . Since  $D_\mu = \partial_\mu + A_{\mu a} T_a$  we may expand

$$D^2 = \partial^2 + \{\partial^\mu, A_{\mu a}\} T_a + A_{\mu a} T_a A^\mu_b T_b. \quad (5.216)$$

In general for determinants of an operator  $X + Y$  we may expand in  $Y$  by using

$$\begin{aligned} \log \det(X + Y) &= \log \det X + \log \det(1 + X^{-1}Y) = \log \det X + \text{tr} \log(1 + X^{-1}Y) \\ &= \log \det X + \text{tr}(X^{-1}Y) - \frac{1}{2} \text{tr}(X^{-1}YX^{-1}Y) + \dots \end{aligned} \quad (5.217)$$

Applying this to obtain an expansion in  $A_\mu$  we get

$$\begin{aligned} \log \det(-D^2) &= \log \det(-\partial^2) - \text{Tr}((-\partial^2)^{-1}(\{\partial^\mu, A_{\mu a}\} T_a + A_{\mu a} T_a A^\mu_b T_b)) \\ &\quad - \frac{1}{2} \text{Tr}((-\partial^2)^{-1} \{\partial^\mu, A_{\mu a}\} T_a (-\partial^2)^{-1} \{\partial^\nu, A_{\nu b}\} T_b) + O(A^3). \end{aligned} \quad (5.218)$$

The traces  $\text{Tr}$  are functional traces but they also include a conventional trace over group indices.

The functional trace can be discussed in various ways, one approach is to introduce bases  $|x\rangle$  and  $|k\rangle$  such that

$$\int d^d x |x\rangle \langle x| = \int \frac{d^d k}{(2\pi)^d} |k\rangle \langle k| = 1, \quad \langle x|k\rangle = e^{ik \cdot x}. \quad (5.219)$$

and

$$\partial_\mu |k\rangle = ik_\mu |k\rangle. \quad (5.220)$$

We then have

$$\langle x|(-\partial^2)^{-1}|y\rangle = \frac{1}{(2\pi)^d} \int d^d k \frac{1}{k^2} e^{ik \cdot (x-y)}. \quad (5.221)$$

If  $X, Y$  are operators satisfying

$$X|x\rangle = X(x)|x\rangle, \quad Y|x\rangle = Y(x)|x\rangle, \quad (5.222)$$

then, since by definition  $\text{Tr}(O) = \int d^d x \langle x|O|x\rangle$ ,

$$\text{Tr}((-\partial^2)^{-1} X) = \int d^d x \langle x|(-\partial^2)^{-1}|x\rangle X(x) = \frac{1}{(2\pi)^d} \int d^d k \frac{1}{k^2} \int d^d x X(x), \quad (5.223)$$

and, introducing integrations over  $|x\rangle\langle x|$  and also  $|y\rangle\langle y|$ ,

$$\begin{aligned} \text{Tr}((-\partial^2)^{-1} X(-\partial^2)^{-1} Y) &= \int d^d x \int d^d y X(x) Y(y) \langle x|(-\partial^2)^{-1}|y\rangle\langle y|(-\partial^2)^{-1}|x\rangle \\ &= \int d^d x \int d^d y X(x) Y(y) \frac{1}{(2\pi)^{2d}} \int d^d k d^d k' e^{i(k-k')\cdot(x-y)} \frac{1}{k^2 k'^2} \\ &= \frac{1}{(2\pi)^{2d}} \int d^d p \tilde{X}(p) \tilde{Y}(-p) \int d^d k \frac{1}{k^2(k-p)^2}, \end{aligned} \quad (5.224)$$

for

$$\tilde{X}(p) = \int d^d x e^{ip\cdot x} X(x), \quad \tilde{Y}(p) = \int d^d x e^{ip\cdot x} Y(x). \quad (5.225)$$

Applying these results to the calculation of  $\log \det(-D^2)$  then since  $\text{tr}(T_a) = 0$  there is no linear term in  $A_\mu$ . For the  $O(A^2)$  term in the first line this approach gives

$$\begin{aligned} \text{Tr}((-\partial^2)^{-1} A_{\mu a} T_a A^{\mu}_b T_b) &= \int d^d x \langle x|(-\partial^2)^{-1}|x\rangle \text{tr}(A_{\mu a}(x) T_a A^{\mu}_b(x) T_b) \\ &= \int d^d x \text{tr}(A_{\mu a}(x) T_a A^{\mu}_b(x) T_b) \int \frac{d^d k}{(2\pi)^d} \frac{1}{k^2}. \end{aligned} \quad (5.226)$$

This result may be represented by the FEYNMAN graph, where  $A_{\mu a}$  and  $A_{\nu b}$  are attached to the external lines,

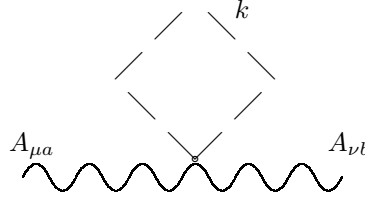

For the remaining contribution we can calculate the trace in a similar fashion as above

$$\begin{aligned} &-\frac{1}{2} \text{Tr}((-\partial^2)^{-1} \{\partial^\mu, A_{\mu a}\} T_a (-\partial^2)^{-1} \{\partial^\nu, A_{\nu b}\} T_b) \\ &= -\frac{1}{2} \int d^d x \int d^d y \text{tr}(A_{\mu a}(x) T_a A_{\nu b}(y) T_b) \\ &\quad \times (\langle y|\partial^\nu(-\partial^2)^{-1}\partial^\mu|x\rangle\langle x|(-\partial^2)^{-1}|y\rangle + \langle y|\partial^\nu(-\partial^2)^{-1}|x\rangle\langle x|\partial^\mu(-\partial^2)^{-1}|y\rangle \\ &\quad + \langle n|(-\partial^2)^{-1}\partial^\mu|x\rangle\langle x|(-\partial^2)^{-1}\partial^\nu|y\rangle + \langle y|(-\partial^2)^{-1}|x\rangle\langle x|\partial^\mu(-\partial^2)^{-1}\partial^\nu|y\rangle) \\ &= \frac{1}{2} \int d^d x \int d^d y \text{tr}(A_{\mu a}(x) T_a A_{\nu b}(y) T_b) \int \frac{d^d k}{(2\pi)^d} \int \frac{d^d k'}{(2\pi)^d} \frac{(k+k')^\mu (k+k')^\nu}{(k^2-i\epsilon)(k'^2-i\epsilon)} e^{i(k-k')\cdot(x-y)}, \end{aligned} \quad (5.227)$$

adopting now the usual  $i\epsilon$  prescription in the denominators. The result is a FEYNMAN integral corresponding to the diagram with two external vector lines

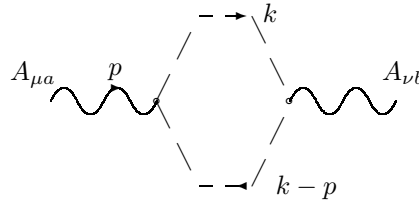

In terms of the FOURIER transform  $\tilde{A}_{\mu a}(p) = \int d^d x e^{ip\cdot x} A_{\mu a}(x)$  we then have, letting  $k' = k - p$ ,

$$\log \det(-D^2)/(-\partial^2) = \frac{i}{(2\pi)^d} \int d^d p I^{\mu\nu}(p) \text{tr}(\tilde{A}_{\mu a}(p) T_a \tilde{A}_{\nu b}(-p) T_b) + O(A^3), \quad (5.228)$$

where

$$I_{\mu\nu}(p) = \frac{1}{2} \frac{1}{(2\pi)^{d_i}} \int d^d k \frac{(2k-p)_\mu(2k-p)_\nu}{(k^2-i\epsilon)((k-p)^2-i\epsilon)} - \eta_{\mu\nu} \frac{1}{(2\pi)^{d_i}} \int d^d k \frac{1}{k^2-i\epsilon}. \quad (5.229)$$

This has the crucial property  $p^\mu I_{\mu\nu}(p) = 0$  which may be obtained from  $p \cdot (2k-p) = k^2 - (k-p)^2$  and using translation invariance of the integration. Furthermore using  $(2k-p)^2 = 2(k-p)^2 + 2k^2 - p^2$  we have

$$\eta^{\mu\nu} I_{\mu\nu}(p) = -p^2 I(p) - (d-2) \frac{1}{(2\pi)^{d_i}} \int d^d k \frac{1}{k^2-i\epsilon}, \quad (5.230)$$

where

$$I(p) = \frac{1}{2} \frac{1}{(2\pi)^{d_i}} \int d^d k \frac{1}{(k^2-i\epsilon)((k-p)^2-i\epsilon)}. \quad (5.231)$$

Using dimensional regularisation the last term in  $I_{\mu\nu}(p)$  is zero<sup>47</sup> and hence

$$I_{\mu\nu}(p) = -\frac{1}{d-1} (\eta_{\mu\nu} p^2 - p_\mu p_\nu) I(p). \quad (5.233)$$

$I(p)$  is a standard FEYNMAN integral which has already been calculated. With  $m^2 = 0$  this one loop integral is given just in terms of Gamma functions

$$I(p) = \Gamma(2 - \frac{1}{2}d) \frac{\Gamma(\frac{1}{2}d - 1)^2}{\Gamma(d-2)} \frac{(p^2)^{\frac{1}{2}d-2}}{2(4\pi)^{\frac{1}{2}d}} \sim \frac{1}{\epsilon} \frac{1}{16\pi^2}. \quad (5.234)$$

From the divergent part of  $I(p)$  we find for  $I_{\mu\nu}(p)$ <sup>48</sup>

$$I_{\mu\nu}(p) \sim -\frac{1}{\epsilon} \frac{1}{3} \frac{1}{16\pi^2} (\eta_{\mu\nu} p^2 - p_\mu p_\nu). \quad (5.237)$$

With this result and

$$\text{tr}(T_a T_b) = -C \delta_{ab} \quad (5.238)$$

we get, to  $O(A^2)$ ,

$$\begin{aligned} \log \det(-D^2/(-\partial^2)) &\sim \frac{i}{3\epsilon} \frac{C}{16\pi^2} \int \frac{d^d p}{(2\pi)^d} (\eta^{\mu\nu} p^2 - p^\mu p^\nu) \tilde{A}_{\mu a}(p) \tilde{A}_{\nu b}(-p) \\ &= \frac{i}{6\epsilon} \frac{C}{16\pi^2} \int \frac{d^d p}{(2\pi)^d} (p^\mu \tilde{A}^\nu_a(p) - p^\nu \tilde{A}^\mu_b(p)) (p_\mu \tilde{A}_{\nu a}(-p) - p_\nu \tilde{A}_{\mu a}(-p)) \\ &= \frac{i}{6\epsilon} \frac{C}{16\pi^2} \int d^d x (\partial^\mu A^\nu_a(x) - \partial^\nu A^\mu_a(x)) (\partial_\mu A_{\nu a}(x) - \partial_\nu A_{\mu a}(x)), \end{aligned} \quad (5.239)$$

<sup>47</sup>There are various ways to see that this must be the case; remember the integral

$$-i \int \frac{d^d k}{(2\pi)^d} \frac{1}{k^2 + m^2} = \frac{1}{(4\pi)^{\frac{d}{2}}} \Gamma\left(1 - \frac{d}{2}\right) (m^2)^{\frac{d}{2}-1} \rightarrow 0 \quad \text{as } m^2 \rightarrow 0, \quad (5.232)$$

assuming  $d$  is analytically continued to  $d > 2$ .

<sup>48</sup>A direct calculation of  $I_{\mu\nu}(p)$ , using  $1/(k^2-i\epsilon) = i \int_0^\infty d\alpha e^{-i\alpha(k^2-i\epsilon)}$ , is given by

$$\begin{aligned} I_{\mu\nu}(p) &= i^2 \int_0^\infty d\alpha_1 \int_0^\infty d\alpha_2 \frac{1}{2(2\pi)^{d_i}} \int d^d k (2k-p)_\mu (2k-p)_\nu e^{-i\alpha_1(k^2-i\epsilon) - i\alpha_2((k-p)^2-i\epsilon)} \\ &= i^2 \int_0^\infty d\alpha_1 \int_0^\infty d\alpha_2 e^{-i\frac{\alpha_1\alpha_2}{\alpha_1+\alpha_2} p^2} \\ &\quad \times \frac{1}{2(2\pi)^{d_i}} \int d^d k' \left(2k'_\mu - \frac{\alpha_1 - \alpha_2}{\alpha_1 + \alpha_2} p_\mu\right) \left(2k'_\nu - \frac{\alpha_1 - \alpha_2}{\alpha_1 + \alpha_2} p_\nu\right) e^{-i(\alpha_1+\alpha_2)(k'^2-i\epsilon)}, \end{aligned} \quad (5.235)$$

with the usual trick of completing the square. Under integration  $k'_\mu k'_\nu \rightarrow k'^2 \eta_{\mu\nu}/d$  while  $k'_\mu p_\nu \rightarrow 0$ . Then carrying out the  $k'$  integration and letting  $\alpha_1 \rightarrow -i\alpha_1, \alpha_2 \rightarrow -i\alpha_2$ , assuming  $p^2 > 0$ , we have

$$\begin{aligned} I_{\mu\nu}(p) &= \frac{1}{2(4\pi)^{\frac{1}{2}d}} \int_0^\infty d\alpha_1 \int_0^\infty d\alpha_2 e^{-\frac{\alpha_1\alpha_2}{\alpha_1+\alpha_2} p^2} \frac{1}{(\alpha_1 + \alpha_2)^{\frac{1}{2}d}} \left( \frac{2}{\alpha_1 + \alpha_2} \eta_{\mu\nu} + \left( \frac{\alpha_1 - \alpha_2}{\alpha_1 + \alpha_2} \right)^2 p_\mu p_\nu \right) \\ &= \frac{1}{(4\pi)^{\frac{1}{2}d}} \frac{\Gamma(1 - \frac{1}{2}d) \Gamma(\frac{1}{2}d)^2}{\Gamma(d)} (p^2)^{\frac{1}{2}d-2} (\eta_{\mu\nu} p^2 - p_\mu p_\nu). \end{aligned} \quad (5.236)$$

where the FOURIER transform has been inverted back to position space. This result has a unique gauge invariant completion giving

$$\log \det (-D^2/(-\partial^2)) \sim \frac{i}{6\varepsilon} \frac{C}{16\pi^2} \int d^d x F_a^{\mu\nu}(x) F_{\mu\nu a}(x) = -\frac{2}{3\varepsilon} \frac{C}{16\pi^2} iS[A]. \quad (5.240)$$

The divergent part determinant of the operator  $\Delta$  acting on vector fields can be found in a similar fashion. With the expansion

$$\Delta_\nu^\mu = -(\partial^2 + \{\partial^\lambda, A_{\lambda a} T_a\} + A_{\lambda a} T_a A^\lambda_b T_b) \delta_\nu^\mu - 2F_\nu^\mu{}_a T_a, \quad (5.241)$$

then

$$\begin{aligned} \log \det (\Delta/(-\partial^2)1) &= -d \operatorname{Tr}((-\partial^2)^{-1} A_{\mu a} T_a A^\mu_b T_b) \\ &\quad - \frac{1}{2} d \operatorname{Tr}((-\partial^2)^{-1} \{\partial^\mu, A_{\mu a}\} T_a (-\partial^2)^{-1} \{\partial^\nu, A_{\nu b}\} T_b) \\ &\quad - 2 \operatorname{Tr}((-\partial^2)^{-1} F_\mu^\nu{}_a T_a (-\partial^2)^{-1} F_\nu^\mu{}_b T_b) + O(A^3), \end{aligned} \quad (5.242)$$

where we keep only the terms which are non zero to this order. The factors  $d$  arise from a trace over Lorentz indices. For the final term following the same methods as earlier

$$-\frac{1}{2} \operatorname{Tr}((-\partial^2)^{-1} F_\mu^\nu{}_a T_a (-\partial^2)^{-1} F_\nu^\mu{}_b T_b) = \frac{i}{(2\pi)^d} \int d^d p I(p) \operatorname{tr}(\tilde{F}^{\mu\nu}_a(p) T_a \tilde{F}_{\mu\nu b}(-p) T_b), \quad (5.243)$$

noting that  $F_\mu^\nu{}_a F_\nu^\mu{}_b = -F^{\mu\nu}{}_a F_{\mu\nu b}$ . The  $\varepsilon$ -pole in  $I(p)$  then gives

$$-\frac{1}{2} \operatorname{Tr}((-\partial^2)^{-1} F_\mu^\nu{}_a T_a (-\partial^2)^{-1} F_\nu^\mu{}_b T_b) \sim -\frac{i}{\varepsilon} \frac{C}{16\pi^2} \int d^d x F_a^{\mu\nu}(x) F_{\mu\nu a}(x). \quad (5.244)$$

Combining this with the contribution from the first two terms which is the same as that calculated earlier, apart from the additional factor of  $d$ , gives

$$\log \det (\Delta/(-\partial^2)1) \sim \frac{i}{\varepsilon} \left(\frac{2}{3} - 4\right) \frac{C}{16\pi^2} \int d^d x F_a^{\mu\nu}(x) F_{\mu\nu a}(x) = \frac{40}{3\varepsilon} \frac{C}{16\pi^2} iS[A]. \quad (5.245)$$



## 6 Fermion Currents and Anomalies

The assumptions which lead to NOETHER's theorem and associated WARD-identities as described in section 3.2 may be violated in quantum field theories because the process of regularisation and renormalisation may violate some of the symmetries of the classical LAGRANGIAN. This is the case when the symmetries depend on a particular spacetime dimension so that they are broken by dimensional regularisation. In this case there may be *anomalies* when classical symmetries are not valid in the quantum field theories. In particular such issues arise with DIRAC fields.

### 6.1 Example: Symmetries of the DIRAC LAGRANGIAN

Let us illustrate these issues by considering FERMIONS; we have a LAGRANGIAN

$$\mathcal{L} = -\bar{\psi}(\gamma \cdot \partial + m)\psi, \quad (6.1)$$

where the  $\gamma$  matrices satisfy

$$\{\gamma^\mu, \gamma^\nu\} = 2\eta^{\mu\nu}. \quad (6.2)$$

The definition of  $\gamma^\mu$  can be extended to any number of dimensions  $d$ . The free Lagrangian has a  $U(1)_V$  symmetry under the transformation

$$\psi \rightarrow e^{i\alpha}\psi, \quad \bar{\psi} \rightarrow \bar{\psi}e^{-i\alpha}. \quad (6.3)$$

The change in the action for an  $x$  dependent  $\alpha(x)$  is

$$\delta_\alpha S[\psi, \bar{\psi}] = -i \int d^d x \partial_\mu \alpha(x) \bar{\psi}(x) \gamma^\mu \psi(x), \quad (6.4)$$

which gives the conserved current

$$j^\mu = i\bar{\psi}\gamma^\mu\psi. \quad (6.5)$$

This is a conserved current under the DIRAC equations

$$(\gamma \cdot \partial + m)\psi = 0, \quad \bar{\psi}(-\overleftarrow{\gamma} \cdot \partial + m) = 0. \quad (6.6)$$

We can also consider an axial  $U(1)_A$  symmetry under a transformation

$$\psi \rightarrow e^{i\beta\gamma_5}\psi, \quad \bar{\psi} \rightarrow \bar{\psi}e^{i\beta\gamma_5}, \quad (6.7)$$

where  $\gamma_5^2 = 1$ ,  $\gamma_5^\dagger = \gamma_5$  and  $\{\gamma^\mu, \gamma_5\} = 0$  for all  $\gamma$  matrices. It is easy to see that in the massless case  $m = 0$ ,

$$\delta_\beta \mathcal{L} = 0. \quad (6.8)$$

If we follow the same procedure as before, we cannot extend  $\gamma_5$  to  $d \neq 4$  dimensions since it involves the antisymmetric symbol  $\epsilon_{\alpha\beta\gamma\delta}$ , the essential relation is the trace formula<sup>49</sup>

$$\text{tr}(\gamma_\mu\gamma_\nu\gamma_\sigma\gamma_\rho) = 4i\epsilon_{\mu\nu\sigma\rho}. \quad (6.11)$$

So now considering  $d = 4$ , the variation of the action is

$$\delta_\beta S[\psi, \bar{\psi}] = -i \int d^4 x \partial_\mu \beta(x) \bar{\psi}\gamma^\mu\gamma_5\psi, \quad (6.12)$$

which gives the conserved axial current

$$j_5^\mu = i\bar{\psi}\gamma^\mu\gamma_5\psi. \quad (6.13)$$

<sup>49</sup>For a demonstration of this note that

$$\text{tr}(\gamma_5\gamma_\alpha\gamma^\alpha\gamma_\mu\gamma_\nu\gamma_\sigma\gamma_\rho) = -\text{tr}(\gamma_5\gamma^\alpha\gamma_\mu\gamma_\nu\gamma_\sigma\gamma_\rho\gamma_\alpha), \quad (6.9)$$

using cyclic symmetry of the trace and  $\gamma_5\gamma_\alpha = -\gamma_\alpha\gamma_5$ . Using the standard properties of gamma matrices  $\gamma_\alpha\gamma_\mu\gamma_\nu\gamma_\sigma\gamma_\rho\gamma^\alpha = 2(\gamma_\rho\gamma_\mu\gamma_\nu\gamma_\sigma - \gamma_\sigma\gamma_\mu\gamma_\nu\gamma_\rho + \gamma_\nu\gamma_\mu\gamma_\sigma\gamma_\rho - \gamma_\mu\gamma_\nu\gamma_\sigma\gamma_\rho) + \gamma_\alpha\gamma^\alpha\gamma_\mu\gamma_\nu\gamma_\sigma\gamma_\rho$ . If  $\gamma^\alpha\gamma_\alpha = d1$  the trace formula gives

$$d\epsilon_{\mu\nu\sigma\rho} = -\epsilon_{\rho\mu\nu\sigma} + \epsilon_{\sigma\mu\nu\rho} - \epsilon_{\nu\mu\sigma\rho} + \epsilon_{\mu\nu\sigma\rho} = 4\epsilon_{\mu\nu\sigma\rho}, \quad (6.10)$$

using the antisymmetric properties of the  $\epsilon$ -symbol.

## 6.2 Triangle Graphs

Now let us apply this to calculations and see how far we get in a case where there are potential anomalies. Consider the non-trivial case for a correlation function for three currents

$$\langle j^\mu(x)j^\nu(y)j^\omega(z) \rangle, \quad (6.14)$$

and since the currents satisfy  $\delta_\alpha j^\mu = 0$  we obtain from the WARD identity

$$\partial_\mu^x \langle j^\mu(x)j^\nu(y)j^\omega(z) \rangle = 0. \quad (6.15)$$

Taking the FOURIER transform and factoring off a delta function:

$$\Gamma^{\mu\nu\omega}(p, q, r)(2\pi)^d \delta^d(p + q + r) = \int d^d x d^d y d^d z e^{i(p \cdot x + q \cdot y + r \cdot z)} \langle j^\mu(x)j^\nu(y)j^\omega(z) \rangle. \quad (6.16)$$

For free fields the FEYNMAN diagrams are one loop,

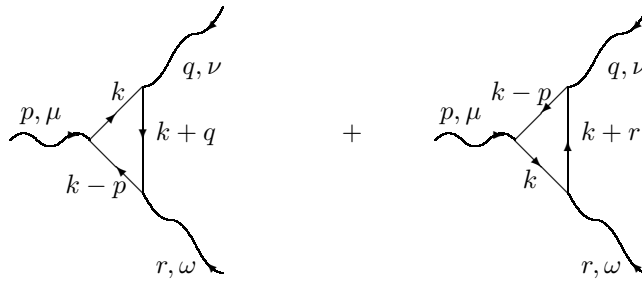

The propagators are given by

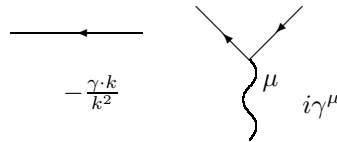

Let us now assume  $m = 0$  for that makes life slightly easier, then the FEYNMAN rules will give us

$$\Gamma^{\mu\nu\omega}(p, q, r) = (-i) \int \frac{d^d k}{(2\pi)^d} \frac{1}{k^2 (k+q)^2 (k-p)^2} \text{tr}(\gamma^\omega \gamma \cdot (k+q) \gamma^\nu \gamma \cdot k \gamma^\mu \gamma \cdot (k-p)) + (q, \nu \leftrightarrow r, \omega), \quad (6.17)$$

where there is a  $-$  sign associated with a FERMION loop. In principle we could evaluate this integral, but that is not what we want. The integral has a degree of divergence  $D = d - 3$ , so that it would apparently not be convergent in four dimensions. However the leading term for large  $k$  has the form

$$\int d^d k \frac{k \cdot k \cdot k}{(k^2)^3} = 0. \quad (6.18)$$

This reduces  $D$  by one.

The WARD identity asserts that

$$p_\mu \Gamma^{\mu\nu\omega}(p, q, r) = 0, \quad (6.19)$$

and there are corresponding identities involving  $q_\nu$  and  $r_\omega$ . To verify this identity we take the contraction inside the integral and then use

$$\gamma \cdot k \gamma \cdot p \gamma \cdot (k-p) = \gamma \cdot (k-p) k^2 - \gamma \cdot k (k-p)^2, \quad (6.20)$$

which allows us to rewrite the integral as

$$p_\mu \Gamma^{\mu\nu\omega}(p, q, r) = (-i) \int \frac{d^d k}{(2\pi)^d} \frac{1}{(k+q)^2} \text{tr} \left( \gamma^\omega \gamma \cdot (k+q) \gamma^\nu \left( \frac{\gamma \cdot (k-p)}{(k-p)^2} - \frac{\gamma \cdot k}{k^2} \right) \right) + (q, \nu \leftrightarrow r, \omega). \quad (6.21)$$

Now consider the shift in the integration so that  $k+q \rightarrow k$ , so that  $k-p \rightarrow k+r$ , in the first term and this becomes

$$p_\mu \Gamma^{\mu\nu\omega}(p, q, r) = (-i) \int \frac{d^d k}{(2\pi)^d} \text{tr} \left( \gamma^\omega \frac{\gamma \cdot k}{k^2} \gamma^\nu \frac{\gamma \cdot (k+r)}{(k+r)^2} - \gamma^\omega \frac{\gamma \cdot (k+q)}{(k+q)^2} \gamma^\nu \frac{\gamma \cdot k}{k^2} \right) + (q, \nu \leftrightarrow r, \omega) = 0, \quad (6.22)$$

using the cyclic property of the trace to show that the various terms cancel. Hence the WARD identity is verified. Using dimensional regularisation all manipulations are justified but note that in  $d=4$  dimensions, the change  $k+q \rightarrow k$  can generate surface terms. Crucially the  $U(1)_V$  symmetry is valid for any  $d$  so the WARD identity is satisfied for the dimensionally regularised theory. Requiring the WARD identity to be obeyed ensures a finite result when  $d=4$  as any potential divergent terms fail to satisfy the identity.

Now consider a situation where there is one or three  $j_5$  currents,

$$\langle j_5^\mu(x) j^\nu(y) j^\omega(z) \rangle \quad \text{or} \quad \langle j_5^\mu(x) j_5^\nu(y) j_5^\omega(z) \rangle. \quad (6.23)$$

For the Fourier transform of  $\langle j_5^\mu(x) j^\nu(y) j^\omega(z) \rangle$  in a similar fashion to the previous case, but now setting  $d=4$  since  $\gamma_5$  is only really defined in four dimensions,

$$\tilde{\Gamma}^{\mu\nu\omega}(p, q, r) = (-i) \int \frac{d^4 k}{(2\pi)^4} \frac{1}{k^2(k+q)^2(k-p)^2} \text{tr}(\gamma^\omega \gamma \cdot (k+q) \gamma^\nu \gamma \cdot k \gamma^\mu \gamma_5 \gamma \cdot (k-p)) + (q, \nu \leftrightarrow r, \omega). \quad (6.24)$$

For  $\langle j_5^\mu j_5^\nu j_5^\omega \rangle$  there are two additional  $\gamma_5$  matrices in the trace but they cancel giving the same result. With the same manipulations as in the previous example:

$$p_\mu \tilde{\Gamma}^{\mu\nu\omega}(p, q, r) = i \int \frac{d^4 k}{(2\pi)^4} \text{tr} \left( \gamma^\omega \frac{\gamma \cdot k}{k^2} \gamma^\nu \frac{\gamma \cdot (k+r)}{(k+r)^2} \gamma_5 - \gamma^\omega \frac{\gamma \cdot (k+q)}{(k+q)^2} \gamma^\nu \frac{\gamma \cdot k}{k^2} \gamma_5 \right) + (q, \nu \leftrightarrow r, \omega) = 0, \quad (6.25)$$

where in the first term we again shift the integration  $k+q \rightarrow q$  so that there is a similar cancellation of terms as in the vector case. However the basic unregularised integral we are dealing with is

$$\int d^4 k \frac{k \cdot k}{(k^2)^2}, \quad (6.26)$$

which is divergent for large  $k$ , so in the shift  $k \rightarrow k' = k+q$  can generate surface terms and the above result can be modified.

For a well defined calculation, without ambiguity or the necessity of considering surface terms under shifts of the integration momentum, it is necessary to regularise the integral. Dimensional regularisation cannot be used so instead we change the propagator to

$$-\frac{\gamma \cdot k}{k^2} \rho(k^2), \quad (6.27)$$

where  $\rho(k^2)$  is a function satisfying  $\rho(k^2) = 1$  for low  $k^2$  and  $\rho \rightarrow 0$  for  $k^2 \rightarrow \infty$ . This will remove the large  $k$  divergence and the integral will have an additional factor in the integrand

$$\rho(k^2) \rho((k+q)^2) \rho((k-p)^2). \quad (6.28)$$

Hence  $p_\mu \tilde{\Gamma}^{\mu\nu\omega}(p, q, r)$  now becomes, after the integration shift  $k + q \rightarrow k$ ,  $k - p \rightarrow k + r$  in the first term,

$$p_\mu \tilde{\Gamma}^{\mu\nu\omega}(p, q, r) = i \int \frac{d^4 k}{(2\pi)^4} \text{tr} \left( \gamma^\omega \frac{\gamma \cdot k}{k^2} \gamma^\nu \frac{\gamma \cdot (k+r)}{(k+r)^2} \gamma_5 \rho(k^2) \rho((k-q)^2) \rho((k+r)^2) \right. \\ \left. - \gamma^\omega \frac{\gamma \cdot (k+q)}{(k+q)^2} \gamma^\nu \frac{\gamma \cdot k}{k^2} \gamma_5 \rho(k^2) \rho((k+q)^2) \rho((k-p)^2) \right) \\ + (q, \nu \leftrightarrow r, \omega). \quad (6.29)$$

The whole expression can then be written in the form:

$$p_\mu \tilde{\Gamma}^{\mu\nu\omega}(p, q, r) = i \int \frac{d^4 k}{(2\pi)^4} \left\{ \text{tr} \left( \gamma^\omega \frac{\gamma \cdot k}{k^2} \gamma^\nu \frac{\gamma \cdot (k+r)}{(k+r)^2} \gamma_5 \right) \rho(k^2) \rho((k+r)^2) \right. \\ \left. \times (\rho((k-q)^2) - \rho((k-p)^2)) \right. \\ \left. - \text{tr} \left( \gamma^\omega \frac{\gamma \cdot (k+q)}{(k+q)^2} \gamma^\nu \frac{\gamma \cdot k}{k^2} \gamma_5 \right) \rho(k^2) \rho((k+q)^2) \right. \\ \left. \times (\rho((k-p)^2) - \rho((k-r)^2)) \right\}. \quad (6.30)$$

For any finite  $k$  this is zero since then we can then take  $\rho = 1$ . Let us on the other hand consider what happens for  $k \gg p, q, r$ , which gives the only possible non zero contributions to the integral. For  $k$  large we may expand

$$\rho((k-q)^2) - \rho((k-p)^2) \approx -\rho'(k^2) 2k \cdot (q-p), \quad (6.31)$$

where  $\rho'$  is the derivative of  $\rho(k^2)$  with respect to  $k^2$ , of course. We can write by standard properties of the DIRAC matrices

$$\text{tr}(\gamma^\omega \gamma \cdot k \gamma^\nu \gamma \cdot (k+r) \gamma_5) = 4i \epsilon^{\omega\sigma\nu\rho} k_\sigma r_\rho. \quad (6.32)$$

With these results the integral becomes

$$p_\mu \tilde{\Gamma}^{\mu\nu\omega}(p, q, r) = 4 \int \frac{d^4 k}{(2\pi)^4} \frac{1}{(k^2)^2} \rho(k^2)^2 \rho'(k^2) \epsilon^{\omega\sigma\nu\rho} (k_\sigma r_\rho 2k \cdot (q-p) - q_\sigma k_\rho 2k \cdot (p-r)), \quad (6.33)$$

where it is possible to show that other contributions in the expansion of  $\rho((k-q)^2) - \rho((k-p)^2)$  are unimportant. On integration  $k_\alpha k_\beta \rightarrow \frac{1}{4} \eta_{\alpha\beta} k^2$ . Also with WICK rotation  $d^4 k \rightarrow i d^4 k$  and then  $k^2 > 0$ ,

$$p_\mu \tilde{\Gamma}^{\mu\nu\omega}(p, q, r) = 8i \epsilon^{\omega\sigma\nu\rho} q_\sigma r_\rho \int \frac{d^4 k}{(2\pi)^4} \frac{1}{k^2} \rho(k^2)^2 \rho'(k^2), \quad (6.34)$$

using  $p = -q - r$ . Integrating over the angles, we can replace

$$d^4 k \rightarrow 2\pi^2 k^3 dk = \pi^2 d(k^2) k^2, \quad (6.35)$$

so that, letting  $\sigma = k^2$ , the essential integral we are dealing with becomes

$$\int_0^\infty d\sigma \rho(\sigma)^2 \rho'(\sigma) = \left[ \frac{1}{3} \rho(\sigma)^3 \right]_0^\infty = -\frac{1}{3}; \quad (6.36)$$

which is independent of the detailed form of  $\rho$ , save that  $\rho(0) = 1$  and that it vanishes at infinity. Finally we have obtained the non zero result

$$\boxed{p_\mu \tilde{\Gamma}^{\mu\nu\omega}(p, q, r) = -\frac{1}{6\pi^2} i \epsilon^{\nu\omega\sigma\rho} q_\sigma r_\rho}, \quad (6.37)$$

which constitutes an anomaly in that it disagrees with the naive expectation. There is a similar result for the other identities, obtained under the simultaneous permutations ( $\mu \rightarrow \nu \rightarrow \omega$ ,  $p \rightarrow q \rightarrow r$ ), since the correlation function is symmetric between all the external lines. Hence also

$$q_\nu \tilde{\Gamma}^{\mu\nu\omega}(p, q, r) = -\frac{1}{6\pi^2} i \epsilon^{\omega\mu\sigma\rho} r_\sigma p_\rho, \quad r_\omega \tilde{\Gamma}^{\mu\nu\omega}(p, q, r) = -\frac{1}{6\pi^2} i \epsilon^{\mu\nu\sigma\rho} p_\sigma q_\rho. \quad (6.38)$$

Other regularisation methods give the same answer, so long as the symmetry under interchange of momenta and Lorentz indices for external lines is maintained, the method used above ensures this since each Fermion propagator is regularised in the same way.

However in general there is a potential ambiguity in  $\tilde{\Gamma}^{\mu\nu\omega}$ , which results by letting

$$\tilde{\Gamma}^{\mu\nu\omega}(p, q, r) + C i\epsilon^{\mu\nu\omega\rho}(q - r)_\rho. \quad (6.39)$$

where the last term will destroy the symmetry under permutations of the three external lines although it is symmetric under  $q, \nu \leftrightarrow r, \omega$ . If

$$C = -\frac{1}{6\pi^2}, \quad (6.40)$$

then including this extra piece we have

$$q_\nu \tilde{\Gamma}^{\mu\nu\omega}(p, q, r) = 0, \quad r_\omega \tilde{\Gamma}^{\mu\nu\omega}(p, q, r) = 0, \quad p_\mu \tilde{\Gamma}^{\mu\nu\omega}(p, q, r) = -\frac{1}{2\pi^2} i\epsilon^{\nu\omega\sigma\rho} q_\sigma r_\rho. \quad (6.41)$$

This is appropriate for  $\langle j_5^\mu(x) j^\nu(y) j^\omega(z) \rangle$  since this need not be fully symmetric and the result ensures there is no anomaly for the vector currents  $j^\nu, j^\omega$ .

Only the surface of anomalies have been touched here.

- END -

# Index

- $\beta$  function, 64, 91
- $\gamma$  function, 64
- $\hat{\tau}$  function, 52
- $\log \det = \text{tr} \log$ , 16
- $\tau$  function, 45
- CALLAN-SYMANZIK equation, 64
- DIRAC LAGRANGIAN, 98
- DIRAC matrices, 98
- DIRAC operator, 36
- EULER'S formula, 15, 23, 47
- FEYNMAN propagator, 20
  - FERMIONIC, 37
  - ghost and gauge field, 80
- FEYNMAN rules, 15, 17
  - for  $\hat{\tau}$  functions, 52
  - scalar field theory, 22
    - momentum space, 23, 46
- GAUSSIAN integral, 10
  - GRASSMANN variables, 33
  - complex, 11
- GRASSMANN variables, 31
  - integration, 32
- GREEN'S function, 19
- KLEIN-GORDON equation, 18
- LEGENDRE transformation, 29
- LEIBNIZ rule for Functional derivatives, 27
- LIE group, 72
  - quadratic form, 73
- MINKOWSKI metric, 18
- NOETHER'S theorem, 39
- PSIAFFIAN, 33
- SCHRÖDINGER equation, 2
- SCHRÖDINGER picture, 2
- WARD identity, 39
- WICK rotation, 46
  
- adjoint representation, 73, 93
- analytic continuation, 8, 47, 70
- angular integration, 52
- anomaly, 98, 102
- asymptotic freedom, 91
- axial current, 98
  
- bare quantities, 62, 90
- BRS charge, 85
- BRS symmetry, 83
  
- commutation relations, 1, 42
- connected, 25
- correlation function, 21
  - connected, 25
- counterterms, 56, 71
- covariant derivative, 73
  
- degree of divergence, 47
- dimensional regularisation, 51
  
- disconnected, 25
- double-slit experiment, 5
  
- effective potential, 69
- expectation values, 12
  
- free field theory, 18
- functional derivative, 18
  
- Gamma function, 51
- gauge fixing, 76
- gauge freedom, 74
- gauge theory, 74
  - physical HILBERT space, 85
- gauge transformation, 73
  - background, 92
- generating functional, 21
  - connected graphs, 26
  - one particle irreducible graphs, 28
- ghost charge, 85
- ghost field, 79
  
- harmonic oscillator
  - FERMIONIC, 34
  
- integration trick, 53, 54
- interacting field theory, 14
  
- lemma, 14
- linear gauge, 79, 83
- LSZ reduction formula, 43
  
- minimal subtraction, 57
- minus signs, 38
  
- negative norm states, 86
- no mathematics, 1
  
- one particle irreducible, 28
- operator field, 42
- ordering ambiguities, 10
  
- path integral, 5
  - FERMIONIC fields, 36
  - gauge theory, 75
  - harmonic oscillator, 6
  - scalar field theory, 18, 21
- perturbation expansion, 14, 21, 92
  - diagrammatic interpretation of, 14
- polarisation states, 87
  
- quantum gravity, 49
  
- renormalisation, 48, 50, 87
  - dimensional analysis, 63
- running coupling, 66
  - asymptotic freedom, 67

dependence on external momenta, 66

step function, 20

subdivergence, 49

subtraction ambiguity, 57

supersymmetry, 83

symmetry factor, 16

theorem, 61

tunnelling, 8

ultraviolet fixed point, 67

vacuum diagrams, 15

vector current, 98

wave function, 2

woods, 26