

Part II Applications of Quantum Mechanics

Lent 2010

Prof. R.R. Horgan

February 25, 2010

Contents

1	The Variational Principle	1
1.1	Estimating E_0	1
1.2	Accuracy	2
1.3	Evaluation of $\langle \psi H \psi \rangle$	2
1.4	Further Results	3
2	Bound States and Scattering States in $D = 1$	5
2.1	Scattering for particle incident from left	6
2.2	Scattering for particle incident from right	7
2.3	The S -matrix	8
2.4	Bound states and the S -matrix	9
2.5	Resonance states and the S -matrix	12
2.6	Properties of $S(k)$	15
3	Classical Scattering in $D = 3$	16
3.1	The Scattering Cross-section	16
4	Quantum Scattering in 3D	19
4.1	Partial wave analysis and phase shifts	20
4.1.1	Partial wave expansion for e^{ikz}	21
4.1.2	Partial wave expansion for scattering states	23
4.1.3	The optical theorem	24
4.1.4	Solving for the asymptotic scattered wave	24
4.1.5	Low-energy scattering	25
4.2	Examples	26
4.2.1	Higher partial waves in the square well	28
4.3	Influence of bound states	28
4.4	Resonance Poles	30

4.5	Green's Functions	31
4.5.1	Integral equations	33
4.5.2	The Born series	34
5	Periodic Structures	36
5.1	Crystal Structure in 3D	38
5.2	Discrete Translation Invariance	40
5.3	Periodic Functions	41
5.4	Reciprocal Vectors and Reciprocal Lattice	41
5.5	Bragg Scattering on a rigid Lattice	43
6	Particle in a One-Dimensional Periodic Potential	46
6.1	Band Structure	47
6.1.1	The Tight Binding Model	48
6.1.2	Bloch's Theorem and Bloch Waves in 1D	50
6.1.3	The Floquet Matrix	51
6.1.4	Brillouin Zones	52
6.1.5	The Nearly-Free Electron Model	53
7	Particle in a 3-Dimensional Periodic Potential	58
7.1	Bloch's Theorem	59
7.2	Ambiguities in k	59
7.3	The Nearly Free Electron Model in 3D	60
7.4	The Tight-Binding Model in 3D	61
7.4.1	Energy Contours	62
8	Electronic Properties	62
8.1	The Effect of Temperature	63
8.2	Insulators and Conductors	64
8.2.1	Dynamics	64
8.3	Semiconductors	66
8.4	More on Extended Zone Scheme	67
8.4.1	Overlapping Bands	67
9	Quantum Particle in a Magnetic Field	68
9.1	Classical Hamiltonian	68
9.2	Quantum Hamiltonian	69

BOOKS

- D.J. Griffiths *Introduction to Quantum Mechanics*, 2nd edition, Pearson Education 2005.
- N.W Ashcroft and N.D. Mermin *Solid-State Physics*, Holt-Saunders 1976.
- L.D. Landau and E.M. Lifshitz *Quantum Mechanics (Course in Theoretical Physics Vol 3*, Butterworth-Heinemann 1976.
- L. Schiff *Quantum Mechanics*, McGraw-Hill Book Company.
- B. Dutta-Roy *Elements of Quantum Mechanics*, New-Age Science Limited.

Other books may be recommended through the course. Also, consult particular topics in library books since many books are good in one area but poor in another.

1 The Variational Principle

A quantum system has a hermitian Hamiltonian H with energy eigenvalues $E_0 \leq E_1 \leq E_2 \leq \dots$, which are assumed to be discrete, and corresponding stationary states (eigenfunctions)

$$\psi_0, \psi_1, \psi_2, \dots \quad (1.1)$$

which are orthogonal and chosen to be normalized to unity.

Let ψ be a general normalized state. Its energy expectation value is

$$\langle E \rangle = \langle \psi | H | \psi \rangle. \quad (1.2)$$

We can always expand ψ on the complete basis of states in eqn. (1.1) as

$$\psi = \sum_{n=0}^{\infty} a_n \psi_n \quad \text{with} \quad \sum_{n=0}^{\infty} |a_n|^2 = 1. \quad (1.3)$$

Then

$$\begin{aligned} \langle E \rangle &= \sum_{n,m} a_n^* a_m \langle \psi_n | H | \psi_m \rangle \\ &= \sum_{n,m} a_n^* a_m E_m \delta_{nm} \\ &= \sum_n |a_n|^2 E_n. \end{aligned} \quad (1.4)$$

Clearly, the minimum of $\langle E \rangle$ is E_0 and occurs when $a_0 = 1$, $a_n = 0, n > 0$; i.e., when $\psi = \psi_0$. This implies the **variational definition** of E_0 :

The ground state energy E_0 is the minimum of $\langle \psi | H | \psi \rangle$ with respect to the choice of ψ , or equivalently of $\frac{\langle \psi | H | \psi \rangle}{\langle \psi | \psi \rangle}$ if ψ is not normalized; this is the **Rayleigh-Ritz quotient**

1.1 Estimating E_0

This is a useful application of the variation approach when ψ_0 and E_0 cannot be easily or accurately computed.

Consider a trial wavefunction ψ which depends on a few parameters α . Calculate

$$\langle E \rangle(\alpha) = \langle \psi | H | \psi \rangle(\alpha) \quad (1.1.1)$$

and minimize with respect to α . The minimum value of $\langle E \rangle$ is an **upper bound** on E_0 since, by expanding ψ as in eqn. (1.3) and using eqn. (1.4), we may always write

$$\langle E \rangle = \sum_n |a_n|^2 E_n = E_0 \sum_n |a_n|^2 + \sum_n |a_n|^2 (E_n - E_0) \geq E_0. \quad (1.1.2)$$

This follows since $\sum_n |a_n|^2 = 1$ and the last term is non-negative since $E_n > E_0, n \geq 1$.

1.2 Accuracy

Write

$$\psi = \frac{1}{\sqrt{1+\varepsilon^2}} (\psi_0 + \varepsilon\psi_\perp), \quad (1.2.1)$$

where ψ_\perp is a linear superposition of ψ_1, ψ_2, \dots , so $\langle \psi_0 | \psi_\perp \rangle = 0 \implies \langle \psi_0 | H | \psi_\perp \rangle = 0$. Then

$$\begin{aligned} \langle E \rangle &= \frac{1}{1+\varepsilon^2} \langle \psi_0 + \varepsilon\psi_\perp | H | \psi_0 + \varepsilon\psi_\perp \rangle \\ &= \frac{1}{1+\varepsilon^2} (E_0 + \varepsilon^2 \langle \psi_\perp | H | \psi_\perp \rangle) \\ &= \frac{1}{1+\varepsilon^2} (E_0 + \tilde{E}) \quad \text{where} \quad \tilde{E} \geq E_1 \\ &= E_0 + \varepsilon^2 (\tilde{E} - E_0) + \dots \end{aligned} \quad (1.2.2)$$

We deduce that an $O(\varepsilon)$ error in ψ gives $O(\varepsilon^2)$ error in estimate for energy E_0 . In many cases can get estimate that is very close to E_0 .

1.3 Evaluation of $\langle \psi | H | \psi \rangle$

For

$$H = -\frac{\hbar^2}{2m} \nabla^2 + V(\mathbf{x}) \quad (1.3.1)$$

have

$$\begin{aligned} \langle \psi | H | \psi \rangle &= \int \psi^*(\mathbf{x}) \left(-\frac{\hbar^2}{2m} \nabla^2 \psi(\mathbf{x}) + V(\mathbf{x}) \psi(\mathbf{x}) \right) d\mathbf{x} \\ &= \int \left(\frac{\hbar^2}{2m} \nabla \psi^*(\mathbf{x}) \cdot \nabla \psi(\mathbf{x}) + \psi^*(\mathbf{x}) V(\mathbf{x}) \psi(\mathbf{x}) \right) d\mathbf{x} \\ &= \langle T \rangle + \langle V \rangle. \end{aligned} \quad (1.3.2)$$

This is applicable in all dimensions. Note that we have used the divergence theorem (\int by parts in 1D) and so the surface term must vanish.

Example

Consider the quartic oscillator in scaled units:

$$H = -\frac{d^2}{dx^2} + x^4$$

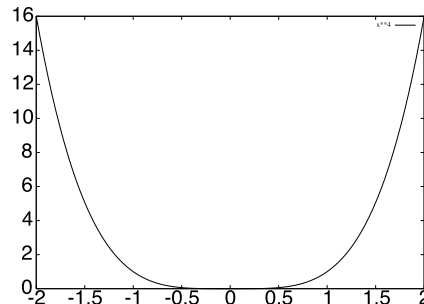

Can solve for the eigenstates numerically. In 1D use Given's procedure, for example, which is basic approach of the CATAM project 5.3. I found the energies, in ascending

order, to be (2 decimal places) 1.06, 3.80, 7.46, 11.64, ... Since the potential is symmetric The states are alternately even and odd parity, with the ground state even (this is always the case).

Use normalized trial wavefunction

$$\psi(x) = \left(\frac{a}{\pi}\right)^{1/4} e^{-ax^2/2} \quad (1.3.3)$$

and get

$$\begin{aligned} \langle E \rangle &= \int \left(\left(\frac{d\psi}{dx}\right)^2 + x^4\psi^2 \right) dx \\ &= \frac{a}{2} + \frac{3}{4a^2}. \end{aligned} \quad (1.3.4)$$

The minimum of $\langle E \rangle$ occurs at $a = 3^{1/3}$ giving the estimate for the ground-state energy $E_0 = 1.08$, which is less than 2% larger (it is always larger) than the true value. The variational and true wavefunctions for ψ_0, ψ_1 are

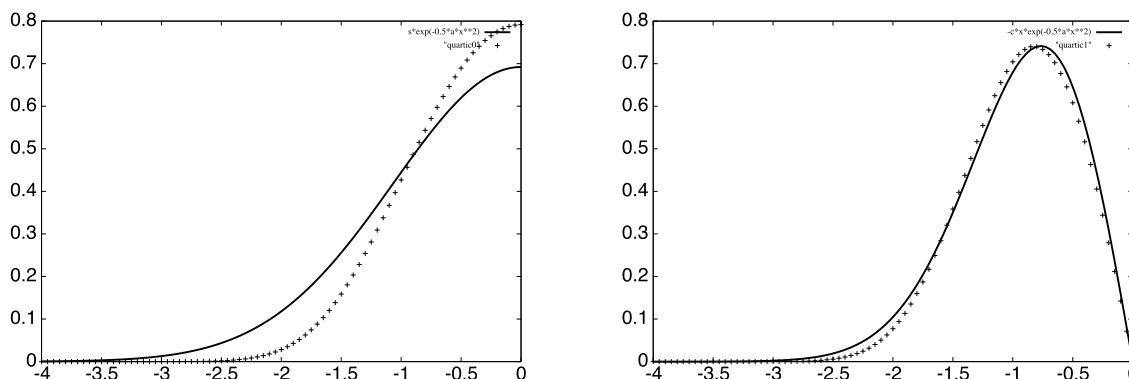

1.4 Further Results

- (1) To estimate E_1 we can use the fact that ψ_1 has odd parity and so use trial wavefunction

$$\psi = \left(\frac{4a^3}{\pi}\right)^{1/4} x e^{-ax^2/2}. \quad (1.4.1)$$

This is already a bit long-winded to work out; I used MAPLE and tried other trial wavefunctions as well, but none so good as the oscillator. The estimate is $E_1 = 3.85$, which is rather good. The variational and correct wavefunctions are shown above.

In general, it is hard to pick out the excited states by clever choice of ψ . Here, we used parity to get E_1 because $V(x)$ is symmetric under reflection. Even then it is not obvious how to get E_2 etc. We need, for example, to choose ψ with even parity and know that we **exactly** have $\langle \psi | \psi_0 \rangle = 0$.

- (2) **Lower bound on E_0 .**

Clearly, $\langle |H| \rangle > \min V$, so $\min V$ is a lower bound on E_0 .

(3) **Virial Theorem.**

Let the potential $V(\mathbf{x})$ be a homogeneous function of degree n ; i.e.,

$$V(\lambda\mathbf{x}) = \lambda^n V(\mathbf{x}), \quad \text{in } D \text{ dimensions.} \quad (1.4.2)$$

Let $\psi_0(\mathbf{x})$ be the true ground state, not necessarily normalized, and assumed real. Then

$$\begin{aligned} E_0 &= \frac{\int \left(\frac{\hbar^2}{2m} \nabla \psi_0(\mathbf{x}) \cdot \nabla \psi_0(\mathbf{x}) + V(\mathbf{x}) \psi_0^2(\mathbf{x}) \right) d^D x}{\int \psi_0^2(\mathbf{x}) d^D x} \\ &= \langle T \rangle_0 + \langle V \rangle_0. \end{aligned} \quad (1.4.3)$$

Now consider $\psi(\mathbf{x}) = \psi_0(\alpha\mathbf{x})$ as a trial wavefunction. Then

$$\langle E \rangle = \alpha^2 \langle T \rangle_0 + \alpha^{-n} \langle V \rangle_0. \quad (1.4.4)$$

Check:

$$\begin{aligned} \langle V \rangle &= \frac{\int V(\mathbf{x}) \psi_0^2(\alpha\mathbf{x}) d^D x}{\int \psi_0^2(\alpha\mathbf{x}) d^D x} = \alpha^{-n} \frac{\int V(\alpha\mathbf{x}) \psi_0^2(\alpha\mathbf{x}) d^D x}{\int \psi_0^2(\alpha\mathbf{x}) d^D x} \\ &= \alpha^{-n} \frac{\int V(\mathbf{y}) \psi_0^2(\mathbf{y}) d^D y}{\int \psi_0^2(\mathbf{y}) d^D y} = \alpha^{-n} \langle V \rangle_0, \end{aligned} \quad (1.4.5)$$

and similarly for the kinetic term, where the kinetic operator has $n = -2$.

The minimum of $\langle E \rangle$ is clearly at $\alpha = 1$ where the result is the exact ground state energy value. Hence, must have

$$2\alpha \langle T \rangle_0 - n\alpha^{-n-1} \langle V \rangle_0 = 0 \quad \text{at } \alpha = 1, \quad (1.4.6)$$

and thus we find

$2\langle T \rangle_0 = n\langle V \rangle_0 \quad \text{The Virial Theorem.} \quad (1.4.7)$
--

Equivalently,

$$E_0 = \left(1 + \frac{2}{n}\right) \langle T \rangle_0 = \left(1 + \frac{n}{2}\right) \langle V \rangle_0. \quad (1.4.8)$$

Examples:

(i) The **harmonic oscillator** has $n = 2$, and so

$$\langle V \rangle_0 = \langle T \rangle_0 = \frac{1}{2} E_0. \quad (1.4.9)$$

(ii) The **coulomb potential** has $n = -1$, and so

$$\langle V \rangle_0 = -2\langle T \rangle_0 \Rightarrow E_0 = -\langle T \rangle_0 \quad \text{negative and so a bound state.} \quad (1.4.10)$$

(iii) The potential $V(r) = 1/r^3$, which has $n = -3$. This is relevant in $D = 3$ when the orbital angular momentum is zero: $l = 0$. Then find

$$E_0 = \left(1 - \frac{2}{3}\right) \langle T \rangle_0 > 0. \quad (1.4.11)$$

This is a contradiction since we assumed that there **was** a bound state; i.e., a state with normalizable wavefunction. In fact, there are no bound states and the particle falls to the centre.

2 Bound States and Scattering States in $D = 1$

Consider the stationary Schrödinger equation in $D = 1$:

$$-\frac{\hbar^2}{2m} \frac{d^2}{dx^2} \psi + V(x)\psi = E\psi, \quad (2.1)$$

where $V(x) \rightarrow 0$ as $x \rightarrow \pm\infty$.

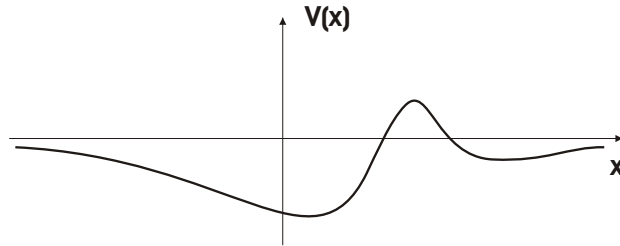

The time-dependence of a stationary state of energy E is $e^{-i\omega t}$ with $\omega = E/\hbar$.

A **bound state** has a negative energy $E = -\hbar^2\kappa^2/2m$, $\kappa > 0$ and it is described by a normalizable wavefunction

$$\psi(x) \sim \begin{cases} a e^{-\kappa x} & x \rightarrow \infty \\ a e^{\kappa x} & x \rightarrow -\infty \end{cases}. \quad (2.2)$$

To obtain the bound state solutions we impose this asymptotic behaviour as a boundary condition. Generically, a solution that is exponentially growing from the left will continue to grow exponentially to the right; bound state solutions are special and discrete. The particle is localized in the neighbourhood of the origin and the probability for finding it at position x when $|x| \rightarrow \infty$ is exponentially small.

A **scattering state** in the same potential has positive energy $E = \hbar^2k^2/2m$, $k > 0$. The asymptotic behaviour of a scattering state can be classified for $x \rightarrow \pm\infty$ as follows:

$x \rightarrow \infty$

$$\psi(x) \sim \begin{cases} a e^{ikx} & \text{right moving, **outgoing/emitted** wave} \\ a e^{-ikx} & \text{left moving, **incoming/incident** wave.} \end{cases} \quad (2.3)$$

$x \rightarrow -\infty$

$$\psi(x) \sim \begin{cases} a e^{ikx} & \text{right moving, **incoming/incident** wave,} \\ a e^{-ikx} & \text{left moving, **outgoing/emitted** wave.} \end{cases} \quad (2.4)$$

The momentum operator is $p = -i\hbar d/dx$ and so the momenta for $e^{\pm ikx}$ are $\pm\hbar k$. Really, the particles are to be thought of as wave packets which are made of a superposition of waves with wave vectors taking values in $(k - \Delta k, k + \Delta k)$; the particles are then localized. This does not materially affect the analysis using the idealized system of pure plane waves.

Why are we concerned with the properties of the scattering wavefunction as $|x| \rightarrow \infty$? It is because we fire a projectile from far away (far enough away for the influence of the potential to be negligible) into the region where the potential is non-zero. We then observe how the particle is deflected by observing the emitted particle trajectory long after the scattering (long on the time-scale of the interaction) and so again far from the region of influence of the potential. If we think of the neighbourhood of the origin as a black box whose properties we probe using projectiles and studying how they scatter in this way, then we can probe the properties of the system (i.e., the potential) located in the region of the origin. This, after all, is how Rutherford discovered the nucleus at the centre of the atom and how we know that quarks exist as point-like objects in elementary particles such as the proton, neutron, pion etc. Indeed, quarks were originally a group-theoretical mathematical device for building the ‘‘periodic table’’ of the many elementary (actually not so elementary) particles. It was only in the 1960s that it was mooted (by Dalitz and others) that they were real and then in the 1970s that their effects were manifest in scattering experiments.

2.1 Scattering for particle incident from left

For each k there is a solution for ψ with no incoming wave from the right; this a standard solution familiar in 1D calculations for reflection and transmission from a potential. A second, independent, solution has no incoming wave from the left (see later). In the former case we have

$$\psi(x) \sim \begin{cases} e^{ikx} + r e^{-ikx} & x \rightarrow -\infty \\ t e^{ikx} & x \rightarrow \infty \end{cases} \quad (2.1.1)$$

$$\begin{aligned} \text{The reflection probability is} & \quad R = |r|^2 \\ \text{The transmission probability is} & \quad T = |t|^2 \end{aligned} \quad (2.1.2)$$

To recap, recall that from the Schrödinger equation and its complex conjugate we can show, for real V and E (i.e., a stationary state), that

$$\begin{aligned} \frac{dj(x)}{dx} &= 0, & j(x) &= -i \frac{\hbar}{2m} \left(\psi^*(x) \frac{d\psi(x)}{dx} - \psi(x) \frac{d\psi^*(x)}{dx} \right) \\ &\Rightarrow j(x) \text{ is constant,} & & \end{aligned} \quad (2.1.3)$$

where $j(x)$ is the probability current. This is equivalent to realizing that the Wronskian for the two independent solutions $\text{Re}(\psi)$ and $\text{Im}(\psi)$ is constant since there is no first-order derivative term in the Schrödinger equation.

For large -ve x

$$\begin{aligned} j(x) &= (e^{-ikx} + r^* e^{ikx}) \frac{\hbar k}{2m} (e^{ikx} - r e^{-ikx}) + \text{complex conjugate} \\ &= \frac{\hbar k}{m} (1 - |r|^2) \end{aligned} \quad (2.1.4)$$

For large +ve x

$$j(x) = \frac{\hbar k}{m} |t|^2 \quad (2.1.5)$$

Thus,

$$1 - |r|^2 = |t|^2 \quad \Rightarrow \quad R + T = 1. \quad (2.1.6)$$

This shows that probability is conserved: the scattering is **unitary**. Note that r, t, R, T are functions of k and hence also of E .

2.2 Scattering for particle incident from right

For each k there is a solution for ψ with no incoming wave from the left. This is the parity reversed situation to the familiar one discussed above. We need not solve again from scratch; indeed we can recover the solution from what has already been done. The Schrödinger equation is real, and so can take the complex conjugate of the solution $\psi(x)$ of the previous section (2.1) and get another solution with asymptotic behaviour

$$\psi^*(x) \sim \begin{cases} e^{-ikx} + r^* e^{ikx} & x \rightarrow -\infty \\ t^* e^{-ikx} & x \rightarrow \infty \end{cases} \quad (2.2.1)$$

Yet another solution is $\tilde{\psi}(x) = \psi^*(x) - r^* \psi(x)$ with asymptotic behaviour

$$\tilde{\psi}(x) \sim \begin{cases} (1 - |r|^2) e^{-ikx} & x \rightarrow -\infty \\ t^* e^{-ikx} - r^* t e^{ikx} & x \rightarrow \infty \end{cases} \quad (2.2.2)$$

Since $tt^* = 1 - |r|^2$, I can write this scattering state normalized to standard form as

$$\psi_L(x) \sim \begin{cases} t e^{-ikx} & x \rightarrow -\infty \\ e^{-ikx} + r' e^{ikx} & x \rightarrow \infty, \end{cases} \quad (2.2.3)$$

This has the particle incident from the right, i.e. **Left-moving**, and then reflected and transmitted with amplitudes for reflection and transmission (use subscript "L" on ψ_L and prime superscript to signify quantities associated with scattering of incident **Left** moving particle.)

$$r' = -\frac{r^* t}{t^*}, \quad t' = \frac{1 - |r|^2}{t^*} = \frac{T}{t^*} = t \quad \text{the transmission amplitudes are } \mathbf{the\ same}. \quad (2.2.4)$$

Then we find the reflection and transmission probabilities are

$$\begin{aligned} R' &= \frac{|r^*t|^2}{|t|^2} = |r|^2 = R && \text{same as for particle incident from left,} \\ T' &= T && \text{also same as for particle incident from left.} \end{aligned} \quad (2.2.5)$$

Clearly, r' and r differ only by an overall phase factor, and $t' = t$. Note that the potential V need not be symmetric about the origin (symmetric here means an even function).

If V is **symmetric** then V commutes with the parity operator $Pf(x) = f(-x)$: $[P, V] = 0$ and hence so does the Hamiltonian $H = p^2/2m + V(x)$: $[P, H] = 0$, and the eigenstates of H , including the scattering states discussed here, can be chosen as simultaneous eigenstate of H and P . The eigenvalues of P are ± 1 since

- (a) P is hermitian and so has real eigenvalues,
- (b) $P\psi(x) = \lambda\psi(x)$ and $P^2\psi(x) = \psi(x) \Rightarrow \lambda^2 = 1$.

Thus, the simultaneous eigenvalues are ($E = k^2/2m, \lambda = \pm 1$).

In the case that $[P, V] = 0$ it is clear that $r' = r$ and $t' = t$ since $\psi(-x)$ of section (2.1) is also a solution but with left and right interchanged.

Note that the equation for r' can be written as

$$r't^* + r^*t = 0, \quad (2.2.6)$$

and for a symmetric potential this is

$$rt^* + r^*t = 0 \Rightarrow \text{Re}(rt^*) = 0. \quad (2.2.7)$$

2.3 The S-matrix

In the previous two sections I defined two different scattering wavefunctions which I shall call ψ_R, ψ_L signifying that the incident particle is **R**ight-moving and **L**eft-moving, respectively. These are two independent complex solutions for the Schrödinger equation with positive energy. Define

Incoming, Right-moving wave: $I_R(k, x) = e^{ikx}, x \rightarrow -\infty$	$\xrightarrow{e^{ikx}} \bullet$
Incoming, Left-moving wave: $I_L(k, x) = e^{-ikx}, x \rightarrow \infty$	$\bullet \xleftarrow{e^{-ikx}}$
Outgoing, Right-moving wave: $O_R(k, x) = e^{ikx}, x \rightarrow \infty$	$\bullet \xrightarrow{e^{ikx}}$
Outgoing, Left-moving wave: $O_L(k, x) = e^{-ikx}, x \rightarrow -\infty$	$\xleftarrow{e^{-ikx}} \bullet$

We can then write our two solutions in matrix form

$$\begin{pmatrix} \psi_R \\ \psi_L \end{pmatrix} = \begin{pmatrix} I_R \\ I_L \end{pmatrix} + \begin{pmatrix} t & r \\ r' & t \end{pmatrix} \begin{pmatrix} O_R \\ O_L \end{pmatrix}. \quad (2.3.1)$$

The matrix in this equation is the **S-matrix**:

$$\mathbf{S} = \begin{pmatrix} t & r \\ r' & t \end{pmatrix}. \quad (2.3.2)$$

This is in the basis of right and left moving waves denoted (R, L) basis. Conservation of probability implies that \mathbf{S} is unitary:

$$\mathbf{S}\mathbf{S}^\dagger = \begin{pmatrix} t & r \\ r' & t \end{pmatrix} \begin{pmatrix} t^* & r'^* \\ r^* & t^* \end{pmatrix} = \begin{pmatrix} |t|^2 + |r|^2 & tr'^* + rt^* \\ r't^* + tr^* & |r'|^2 + |t|^2 \end{pmatrix} = \begin{pmatrix} 1 & 0 \\ 0 & 1 \end{pmatrix}, \quad (2.3.3)$$

where results from the earlier section have been used including eqn. (2.2.6).

When $V = 0$ then $\mathbf{S} = \mathbb{I}$, the unit matrix. The solutions then are

$$\begin{pmatrix} \psi_R \\ \psi_L \end{pmatrix} = \begin{pmatrix} I_R + O_R \\ I_L + O_L \end{pmatrix} = \begin{pmatrix} e^{ikx} \\ e^{-ikx} \end{pmatrix}, \quad (2.3.4)$$

i.e., unscattered right- and left-moving plane waves described by $r = r' = 0$, $t = 1$.

Another way to write the solutions in this (R, L) basis is to emphasize the departure from these non-scattering solutions which is caused by the scattering. After all, this is what we detect as being the non-trivial effect of the scattering potential. We rewrite eqn. (2.3.1) as

$$\begin{pmatrix} \psi_R \\ \psi_L \end{pmatrix} = \begin{pmatrix} e^{ikx} \\ e^{-ikx} \end{pmatrix} + (\mathbf{S} - \mathbb{I}) \begin{pmatrix} O_R \\ O_L \end{pmatrix}. \quad (2.3.5)$$

It is usual to define the **T-matrix** by $\mathbf{T} = \mathbf{S} - \mathbb{I}$, and then $\mathbf{T} = \mathbf{0}$ means there is no scattering:

$$\mathbf{T} = \begin{pmatrix} t - 1 & r \\ r' & t - 1 \end{pmatrix}. \quad (2.3.6)$$

2.4 Bound states and the \mathbf{S} -matrix

It is useful to reformulate the expression for the scattering states discussed above in order to highlight different features that are physically important. This will act as a paradigm for the way in which scattering in $D = 3$ is analyzed and allows the basic concepts to be demonstrated. In particular, we shall generally assume that there are one or more conserved quantum numbers other than E . In 1D this will be parity which is relevant for symmetric potentials $V(x)$.

We shall consider incoming and outgoing waves that are eigenstates of parity, labelled by \pm for even/odd parity, respectively, as well as the wavevector k and consequently also by energy E . This is just a different basis choice and is a linear combination of the (R, L) basis states:

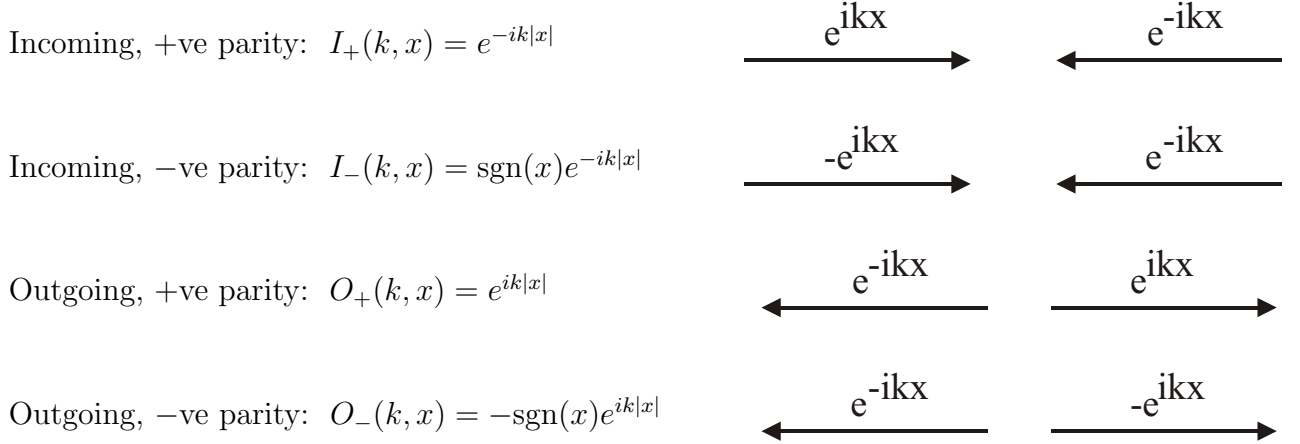

We have that

$$\begin{pmatrix} I_+ \\ I_- \end{pmatrix} = \underbrace{\begin{pmatrix} 1 & 1 \\ -1 & 1 \end{pmatrix}}_{\mathbf{A}} \begin{pmatrix} I_R \\ I_L \end{pmatrix}, \quad \begin{pmatrix} O_+ \\ O_- \end{pmatrix} = \begin{pmatrix} 1 & 1 \\ -1 & 1 \end{pmatrix} \begin{pmatrix} O_R \\ O_L \end{pmatrix} \quad (2.4.1)$$

If there is no scattering potential the incoming particles pass through the origin without suffering any modification and become outgoing particles. The +ve(-ve) parity steady-state wave functions that describes this process are thus

$$\begin{aligned} \psi_+(k, x) &= I_+(k, x) + O_+(k, x) = e^{ikx} + e^{-ikx}, \\ \psi_-(k, x) &= I_-(k, x) + O_-(k, x) = -e^{ikx} + e^{-ikx}. \end{aligned} \quad (2.4.2)$$

When a scattering potential $V(x)$ is present the incoming wave is unaffected, it has yet to encounter the scattering centre, but the outgoing wave is modified. Indeed, if $V(x)$ is not symmetric then an incoming wave of given parity can scatter and produce both +ve and -ve parity outgoing waves. We can then write the scattering wavefunctions in matrix form using the S-matrix:

$$\begin{pmatrix} \psi_+ \\ \psi_- \end{pmatrix} = \begin{pmatrix} I_+ \\ I_- \end{pmatrix} + \mathbf{S}^{(P)} \begin{pmatrix} O_+ \\ O_- \end{pmatrix}, \quad (2.4.3)$$

where $\mathbf{S}^{(P)}$ is the S-matrix in the parity basis:

$$\mathbf{S}^{(P)} = \begin{pmatrix} S_{++} & S_{+-} \\ S_{-+} & S_{--} \end{pmatrix} = \mathbf{A} \mathbf{S} \mathbf{A}^{-1} = \begin{pmatrix} t + (r+r')/2 & (r-r')/2 \\ (r'-r)/2 & t - (r+r')/2 \end{pmatrix}. \quad (2.4.4)$$

The unitarity of $\mathbf{S}^{(P)}$ follows directly from the unitarity of \mathbf{S} ; the relation between them is a similarity transformation.

The important case is when V is symmetric: $[P, V] = 0$. Then $r' = r$ and $\mathbf{S}^{(P)}$ is diagonal:

$$\mathbf{S}^{(P)} = \begin{pmatrix} t+r & 0 \\ 0 & t-r \end{pmatrix}, \quad (2.4.5)$$

and parity is conserved in the scattering process; a +ve(-ve) incoming state scatters only into a +ve(-ve) outgoing state. Clearly, unitarity of $\mathbf{S}^{(P)}$ in this case means

$$\begin{aligned} |S_{++}|^2 &= |S_{--}|^2 = 1 \Rightarrow \\ S_{++} &= t+r = e^{2i\delta_+}, \quad S_{--} = t-r = e^{2i\delta_-}. \end{aligned} \quad (2.4.6)$$

Here δ_{\pm} encode the phase shifts of the **outgoing** waves O_{\pm} with respect to the case of **no scattering**. Thus, $\delta_{\pm} \neq 0$ signifies the occurrence of scattering and they are all we need to know to describe and quantify the process.

Consider the example of scattering from the square well potential

$$V(x) = \begin{cases} -V_0 & |x| < a/2 \\ 0 & |x| > a/2 \end{cases} \quad (2.4.7)$$

The transmission (t) and reflection (r) amplitudes are given by

$$t = \frac{2ikq e^{-ika}}{D(k)}, \quad r = \frac{(k^2 - q^2) \sin qa e^{-ika}}{D(k)}$$

$$\text{where } D(k) = 2ikq \cos qa + (k^2 + q^2) \sin qa, \quad q^2 = k^2 + \frac{2mV_0}{\hbar^2}. \quad (2.4.8)$$

We set $\alpha = qa/2$ and then can write the denominator D as

$$\begin{aligned} D(k) &= 2ikq(\cos^2 \alpha - \sin^2 \alpha) + (k^2 + q^2)2 \sin \alpha \cos \alpha \\ &= 2 \cos^2 \alpha (q \tan \alpha + ik)(q - ik \tan \alpha) \end{aligned} \quad (2.4.9)$$

Now $S_{++} = t + r$ and $S_{--} = t - r$ and the numerators of these expressions are

$$\begin{aligned} N_{\pm}(k) &= (2ikq \pm (k^2 - q^2) \sin qa) e^{-ika} = (2ikq \pm 2(k^2 - q^2) \sin \alpha \cos \alpha) e^{-ika} \\ &= 2 \cos^2 \alpha (q \tan \alpha \mp ik)(ik \tan \alpha \mp q) e^{-ika}. \end{aligned} \quad (2.4.10)$$

Thus, after all the algebra we find that

$$S_{++} = -e^{-ika} \frac{(q \tan \alpha - ik)}{(q \tan \alpha + ik)} \equiv \frac{f_+^*(k)}{f_+(k)} = \frac{f_+(-k)}{f_+(k)}, \quad (2.4.11)$$

$$S_{--} = e^{-ika} \frac{(q + ik \tan \alpha)}{(q - ik \tan \alpha)} \equiv \frac{f_-^*(k)}{f_-(k)} = \frac{f_-(-k)}{f_-(k)}, \quad (2.4.12)$$

These expressions are both unitary since they are the ratios of a complex expression and its complex conjugate.

The important feature is that, as a function of k , both $S_{++}(k)$ and $S_{--}(k)$ have a pole at imaginary value of k and an associated zero in the complex conjugate position. We examine the meaning using the example of scattering of a +ve parity wave on the well.

We have

$$\psi_+(k, x) = I_+(k, x) + S_{++}(k)O_+(k, x). \quad (2.4.13)$$

We now observe that we can analytically continue I_+ and O_+ in the complex k -plane and note for $k = -i\kappa$ that $I_+(-i\kappa, x)$ **decays** exponentially in both left and right regions, and similarly for $O_+(i\kappa, x)$:

$$I_+(-i\kappa, x) = O_+(i\kappa, x) = e^{-\kappa|x|}$$



However, the state $\psi_+(k, x)$ is **still** a solution of the Schrödinger equation for these values of $k : k = \mp i\kappa$. In the special case that S_{++} in eqn. (2.4.13) has a **zero** at $k = -i\kappa$ then the first term, the term with $I_+(-i\kappa, x)$, is all that is left and the state has only the exponentially decaying contribution.

$$\psi_+(-i\kappa, x) \sim e^{-\kappa|x|}. \quad (2.4.14)$$

Because of the form of $S_{++}(k)$ we expect that if S_{++} has a zero at $k = -i\kappa$ then it will have a pole at $k = i\kappa$. Then in eqn. (2.4.13) the second term, the term with $O_+(i\kappa, x)$, dominates the first term and, for the properly normalized state, again

$$\psi_+(i\kappa, x) \sim e^{-\kappa|x|}. \quad (2.4.15)$$

In the case here the zero(pole) are at $k = -i\kappa(i\kappa)$ where from eqn. (2.4.11)

$$\kappa = q \tan qa/2 \quad \text{remember} \quad \alpha = qa/2, \quad q^2 + \kappa^2 = \frac{2mV_0}{\hbar^2}. \quad (2.4.16)$$

The solutions for κ are indeed the solutions for the +ve parity bound states of the square well. A similar result holds for the -ve parity states and S_{--} .

These are certainly bound state solutions and so we have the very important result for potentials $V(x)$ that vanish sufficiently fast as $|x| \rightarrow \infty$:

Let $V(x)$ be a potential such that $V(x) \rightarrow 0$ for $|x| \rightarrow \infty$. Then to each bound state state of V , $\phi(\kappa, x) \sim \exp(-\kappa|x|)$ $|x| \rightarrow \infty$, there is an associated zero of the S-matrix $\mathbf{S}(k)$ on the negative imaginary k axis at $k = -i\kappa$, and a corresponding pole on the positive imaginary k -axis at $k = i\kappa$.

Caveat: the inverse statement is not always true. Not every zero(pole) of \mathbf{S} corresponds to a bound state. This will only be the case if the potential $V(x)$ is localized, by which is meant essentially that, as $|x| \rightarrow \infty$, V falls off faster than any exponential. This is true for any potential which is zero outside some neighbourhood of the origin or, for example, for a potential decaying like a Gaussian function at large $|x|$. This is true for the foregoing analysis where we have only demonstrated the result for localized V ; we could then identify the **exact** solutions to be plane-waves outside the range of V . This needs more effort if V is not localized.

The analytic properties of $S(k)$ in the complex k -plane are important in the analysis of scattering.

2.5 Resonance states and the S-matrix

We will look at another important scattering result: the effect of states that are quasisustainable/metastable. We examine this by an example. Consider the potential consisting of two delta functions of equal strength, V_0 , at $x = \pm 1$.

$$V(x) = V_0\delta(x - 1) + V_0\delta(x + 1). \quad (2.5.1)$$

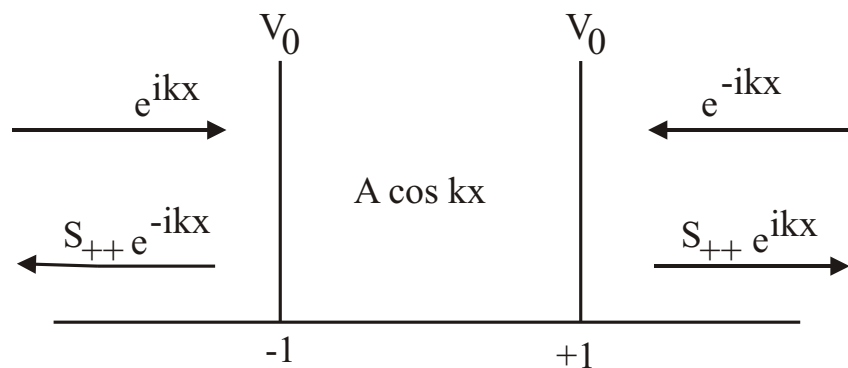

Here is shown the scattering of the +ve parity partial wave: $I_+(k, x)$ scatters into $O_+(k, x)$. A similar diagram for the negative parity waves has $\psi(x) = A \sin kx$ in $-1 < x < 1$. The boundary conditions are that ψ is continuous and, defining $U_0 = 2mV_0/\hbar^2$,

$$\text{Disc } \frac{d\psi}{dx} \Big|_{x=-1} = U_0\psi, \quad \text{Disc } \frac{d\psi}{dx} \Big|_{x=1} = U_0\psi. \quad (2.5.2)$$

Carry out the matching calculation in the usual way but now only need to match at **one** boundary, $x = 1$ say, since parity ensures the boundary conditions are satisfied at the other boundary. (see example sheet). We consider only the +ve parity waves to demonstrate the result. We get

$$S_{++} = e^{-2ik} \left[\frac{(2k - iU_0)e^{ik} - iU_0e^{-ik}}{(2k + iU_0)e^{-ik} + iU_0e^{ik}} \right]. \quad (2.5.3)$$

This is clearly unitary as it is the ratio of a function and its conjugate.

- (1) For $V_0 \rightarrow \infty$ with k finite we find

$$S_{++} \rightarrow -e^{-2ik}. \quad (2.5.4)$$

This is to be expected since it corresponds to pure reflection off an impenetrable barrier. The “-” sign is the standard change of phase on reflection and the phase factor is there because the wave is reflected rather than passing through and hence has travelled a distance $\Delta x = 2$ less far.

- (2) Consider the pole positions of S_{++} . These are at

$$e^{2ik} = - \left(1 - \frac{2ik}{U_0} \right). \quad (2.5.5)$$

For $k/U_0 \rightarrow 0$ (i.e. $V_0 \rightarrow \infty$) the solutions are $k = (n + 1/2)\pi$. These correspond to the symmetric bound states in the interior region $-1 < x < 1$. Consider just $n = 0$ from now on. This state looks like:

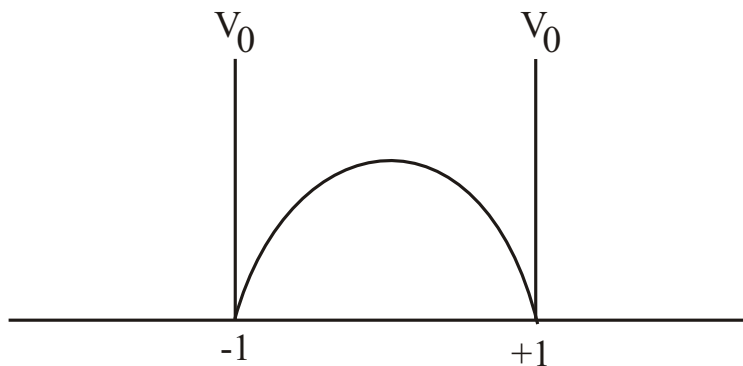

Now consider the pole position for U_0 finite but still $U_0/k \gg 1$. We expect it to be close to the bound state pole positions. Take example with $n = 0$ and propose

$$k = \frac{\pi}{2} + \alpha - i\gamma. \quad (2.5.6)$$

We expect α, γ to vanish as $V_0 \rightarrow \infty$ and will find that a power series in $1/U_0$ will suffice. We need to solve

$$e^{i\pi} e^{2(i\alpha+\gamma)} = - \left(1 - \frac{2ik}{U_0}\right) \Rightarrow e^{2(i\alpha+\gamma)} = \left(1 - \frac{2ik}{U_0}\right). \quad (2.5.7)$$

After some algebra find

$$\alpha = -\frac{\pi}{2U_0} + \frac{\pi}{2U_0^2}, \quad \gamma = \frac{\pi^2}{4U_0^2}. \quad (2.5.8)$$

[Note, it is easier to solve after realizing that γ is $O(1/U_0^2)$.]

Thus, the pole is at a **complex** value of momentum and lies in the lower-half of the complex k -plane. Write $k = p - i\gamma$ with $p = \pi/2 + \alpha$ and $\gamma > 0$. There is, of course, a zero at the conjugate point. What does all this signify?

- (i) The state inside the potential region is no longer bound but is quasistable and once established only leaks out very slowly as long as V_0 is large.
- (ii) The wavefunction continued to the pole value for k is dominated by $O_+(k)$ for $|x| > 1$:

$$\psi_+(k, x) \sim e^{ip|x|} e^{\gamma|x|}. \quad (2.5.9)$$

I.e., at a fixed time the wavefunction **increases** with $|x|$. Suppose we have put the particle into $-1 < x < 1$ and it occupies a state of energy E . This is not an eigenstate since it eventually escapes by tunnelling. However, if V_0 is large it will be close to one of the stationary states (here we chose the ground state).

Suppose this happened at $t = -T$; it is like an excited atom which will eventually decay. The particle is said to be in a metastable or **quasi-stationary** state. Radioactive decay is described by similar systems. As t increases the particle leaks out to ∞ and at $t = 0$ the wavefunction looks like

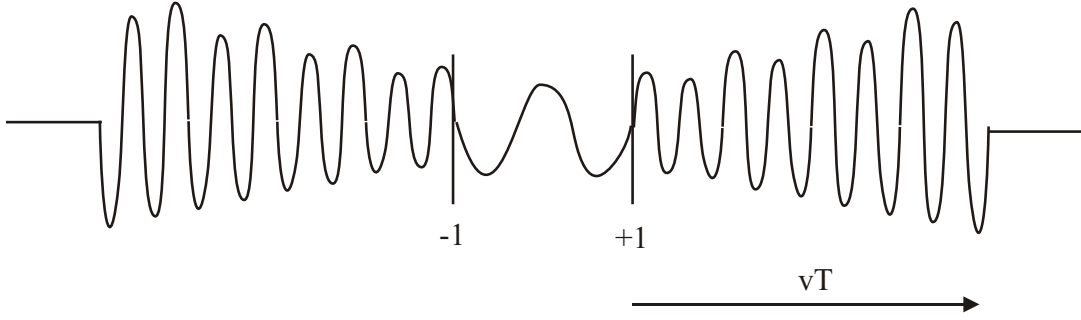

Here v is the particle velocity. The wavefunction is bigger at larger $|x|$ since there was a larger particle current at early times and it has travelled further by $t = 0$. The wavefunction, of course, is zero for $|x| > vT$ and the whole state is still normalized.

The complex energy is given by $E_c = \hbar^2 k^2 / 2m$ and we find

$$E_c \sim E_0 - \frac{1}{2}i\Gamma, \quad (2.5.10)$$

where

$$E_0 = \frac{\hbar^2 p^2}{2m} \quad \text{and is very close to the bound state energy,}$$

$$\Gamma = \frac{2\hbar^2 p \gamma}{m} \quad \text{and } \Gamma > 0. \quad (2.5.11)$$

The time dependence of the state is then

$$e^{-iE_c t / \hbar} = e^{-iE_0 t / \hbar} e^{-\Gamma t / 2\hbar}. \quad (2.5.12)$$

I.e., at **fixed** x the state decays with characteristic time $\tau = 1/\Gamma$; this controls the half-life of the state and Γ is called the width of the state. (Note that the probability is proportional to $|\psi^2|$ and so decays with $\exp(-\Gamma t)$.)

As a function of energy then S_{++} will have the form

$$S_{++} \sim \frac{E - E_0 - \frac{1}{2}i\Gamma}{E - E_0 + \frac{1}{2}i\Gamma}. \quad (2.5.13)$$

The quasi-stationary state is also called a **resonance** and in general the S-matrix has this characteristic form when E is near to E_0 .

2.6 Properties of $\mathbf{S}(k)$

- (1) $\mathbf{S}\mathbf{S}^\dagger = \mathbb{I}$: probability conservation means \mathbf{S} is **unitary**. If \mathbf{S} is diagonal then $S_{\alpha\beta}(k) = e^{2i\delta_\alpha(k)} \delta_{\alpha\beta}$ (do not confuse notation using “ δ ” twice here).
- (2) Complex conjugation $*$ and $k \rightarrow -k$ have the same effect on the incoming and outgoing states: $I_+ \leftrightarrow O_+$, $I_- \leftrightarrow -O_-$. Thus,

$$\psi^*(k) = \psi(-k) \implies \mathbf{S}^*(k) = \mathbf{S}(-k). \quad (2.6.1)$$

For diagonal \mathbf{S} this implies $\delta_\alpha(-k) = -\delta_\alpha(k)$; the phase shifts are **odd** functions of k .

3 Classical Scattering in $D = 3$

Scattering of particles is used to probe the general structure of matter. It reveals the constituent particles composing matter (such as atoms, nuclei and quarks), determines their sizes, the characteristic length scales of structures (such as the lattice spacing in a crystal) and the nature of the forces which act. In the previous section we have established most of the mathematical features of scattering but in 3D there are generalizations of these ideas.

3.1 The Scattering Cross-section

First we define the **impact parameter** b and the **scattering angle** θ :

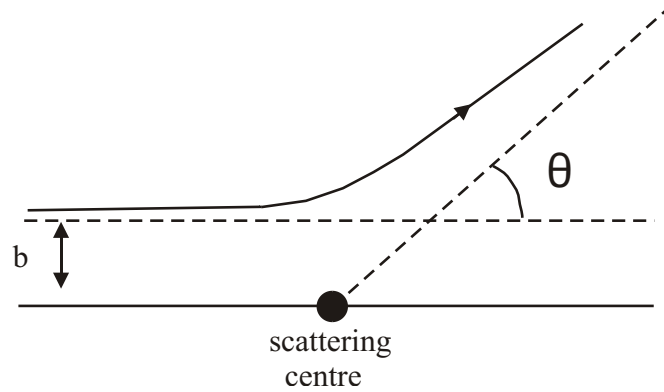

The scattering angle is the angle between the asymptotic trajectories at late and early times and the impact parameter is the closest distance of approach **if** the particle were to suffer no scattering. We will ignore recoil and assume azimuthal symmetry at least. The trajectory is then planar.

We shall calculate or measure $\theta(b)$ or, better, $b(\theta)$.

Example of hard sphere:

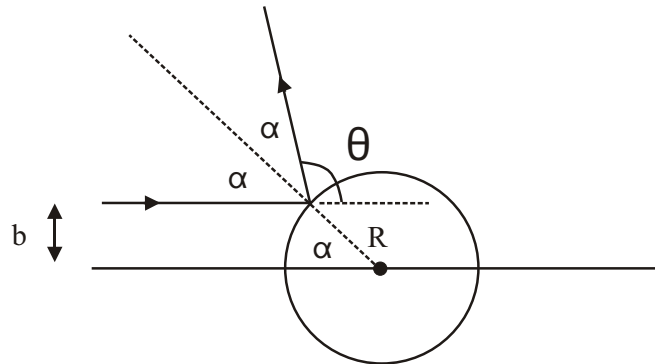

Here

$$\begin{aligned} b &= R \sin \alpha, \quad \theta = \pi - 2\alpha \implies \\ b &= R \sin \left(\frac{\pi}{2} - \frac{\theta}{2} \right) = R \cos \frac{\theta}{2}. \end{aligned} \quad (3.1.1)$$

There is no scattering if $b \geq R$.

Idea of the Cross-section:

The cross-section is a measure of the size of the scattering centre presented to the incoming beam. As its name suggests it is in units of (metres)² although the natural unit in atomic/nuclear/particle physics is the **barn** = $10^{-28}m^2$ and a more usual version is the nanobarn (nb) = $10^{-9}b$. For classical scattering this is a simple idea but in quantum mechanics the scattering cross-section generally varies strongly with the energy of the incoming beam and can be particularly large for those energies corresponding to resonance poles as were discussed in the previous section. The full calculation also takes into account diffraction effects which are absent classically. The picture which explains how the cross-section is defined for both classical and quantum scattering is

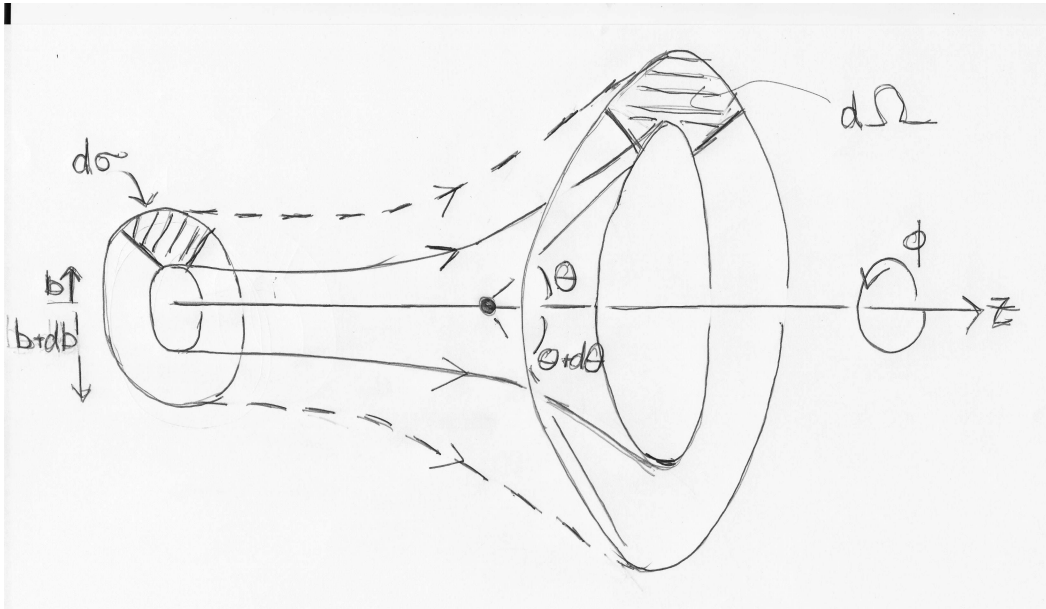

Consider infinitesimal cross-sectional area $d\sigma$ of incident beam that scatters into infinitesimal solid angle $d\Omega$. Geometrically

$$d\sigma = b db d\phi, \quad d\Omega = \sin \theta d\theta d\phi. \quad (3.1.2)$$

Note, $d\phi$ is the same in both cases if we have azimuthal symmetry. Then

$$\text{the differential cross-section is } D(\theta) = \left| \frac{d\sigma}{d\Omega} \right| = \frac{b}{\sin \theta} \left| \frac{db}{d\theta} \right|. \quad (3.1.3)$$

$D(\theta)$ has units of area.

Hard sphere:

$$\begin{aligned} \frac{db}{d\theta} &= -\frac{R}{2} \sin \frac{\theta}{2} \implies \\ D(\theta) &= \frac{\left(R \cos \frac{\theta}{2}\right) \left(\frac{R}{2} \sin \frac{\theta}{2}\right)}{\sin \theta} = \frac{R^2}{4}. \end{aligned} \quad (3.1.4)$$

The **total cross-section**, σ , is

$$\sigma = \int D(\theta) d\Omega = 2\pi \int_{-1}^1 D(\theta) d \cos \theta. \quad (3.1.5)$$

σ is the total area of the beam that is scattered. For the hard sphere scattering

$$\sigma = \frac{R^2}{4} 4\pi = \pi R^2, \quad (3.1.6)$$

i.e., the geometrical area presented to the beam.

Coulomb (Rutherford) scattering:

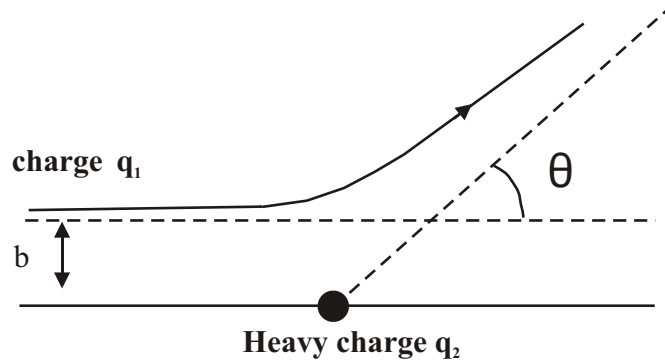

Beam particles have kinetic energy E . Orbit theory gives

$$b = \frac{q_1 q_2}{8\pi\epsilon_0 E} \cot \frac{\theta}{2}, \quad (3.1.7)$$

and hence the differential cross-section is

$$D(\theta) = \left| \frac{d\sigma}{d\Omega} \right| = \left(\frac{q_1 q_2}{16\pi\epsilon_0 E} \right)^2 \frac{1}{(\sin \theta/2)^4}. \quad (3.1.8)$$

The total cross-section is infinite. This arises because the coulomb, inverse square, force is of infinite range and is special. Indeed, it has to be dealt with very carefully in general. The infinity arises because the beam is idealized as being of infinite transverse extent whereas, in practice, no beam is like this; in QM the particles are in wavepackets. This is one case where the idealization goes wrong. However, it is only relevant to very small scattering angles which are never observed in practice.

4 Quantum Scattering in 3D

The target is described by the fixed potential $V(\mathbf{r})$, $V \rightarrow 0$ as $r \rightarrow \infty$ ($r = |\mathbf{r}|$) and the scattering is described by the wavefunction $\psi(\mathbf{r})$ satisfying the Schrödinger equation

$$\left[-\frac{\hbar^2}{2m} \nabla^2 + V(\mathbf{r}) \right] \psi(\mathbf{r}) = E\psi(\mathbf{r}), \quad (4.1)$$

with $E > 0$. The analysis follows a similar path to that already discussed for scattering in 1D but with some important differences. We look for a stationary (time-independent) description of the scattering visualized as

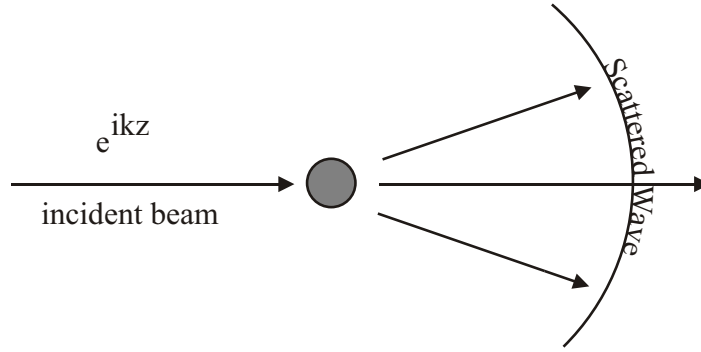

This is a steady state with continuous incident beam and an outgoing scattered spherical wave. The appropriate boundary condition for $\psi(\mathbf{r})$ as $r \rightarrow \infty$ is

$$\psi(\mathbf{r}) \sim \underbrace{e^{ikz}}_{\text{incident wave}} + \underbrace{f(\hat{\mathbf{r}}) \frac{e^{ikr}}{r}}_{\text{scattered wave}}. \quad (4.2)$$

The probability current is

$$\mathbf{j}(\mathbf{r}) = -i \frac{\hbar}{2m} (\psi^* \nabla \psi - \psi \nabla \psi^*), \quad \text{with } \nabla \cdot \mathbf{j} = 0. \quad (4.3)$$

For

$$\psi = \psi_{in} = e^{ikz} : \quad \mathbf{j}_{in} = \frac{\hbar k}{m} \hat{\mathbf{z}} = \mathbf{v}. \quad (4.4)$$

Note, one particle per unit volume in the beam. For

$$\begin{aligned} \psi &= \psi_{scatt} = f(\hat{\mathbf{r}}) \frac{e^{ikr}}{r} : \quad \nabla \psi \sim ik f(\hat{\mathbf{r}}) \frac{e^{ikr}}{r} \hat{\mathbf{r}} + O(r^{-2}) \implies \\ \mathbf{j}_{scatt} &= \frac{\hbar k}{m} \frac{1}{r^2} |f(\hat{\mathbf{r}})|^2 \hat{\mathbf{r}} + O(r^{-3}) \end{aligned} \quad (4.5)$$

Interference terms (not shown) between the incident and scattered wave arise as a consequence of the idealization of using plane waves rather than wavepackets. Can construct a beam of finite transverse extent using superposition without materially

affecting the scattering amplitude; the incident beam and scattered particles are then separated and no interference at large r occurs. So:

$$\begin{aligned} \text{The **scattered** flux into element } d\Omega \text{ of solid angle} &= \frac{\hbar k}{m} |f(\hat{\mathbf{r}})|^2 d\Omega \\ \text{The **incident** flux per unit area} &= \frac{\hbar k}{m}. \end{aligned} \quad (4.6)$$

We then have

$$\begin{aligned} d\sigma &= \frac{\text{scattered flux into } d\Omega}{\text{incident flux per unit area}} \implies \\ \frac{d\sigma}{d\Omega} &= |f(\theta, \phi)|^2. \end{aligned} \quad (4.7)$$

$f(\theta, \phi)$ is called the **scattering amplitude**. If V is spherically symmetric, $V(\mathbf{r}) = V(r)$, then f is independent of ϕ .

4.1 Partial wave analysis and phase shifts

We have seen many of the ideas earlier. In the 1D case we had partial waves I_{\pm} and O_{\pm} labelled by parity, and for symmetric V the S-matrix was parametrized by phase-shifts, δ_{\pm} for each partial wave. In 3D, for spherically symmetric V , the angular momentum $l = 0, 1, 2, \dots$ is a good quantum number. The partial waves will be labelled by l and the S-matrix parametrized by δ_l . Wish to solve

$$\left[-\frac{\hbar^2}{2m} \nabla^2 + V(r) \right] \psi(\mathbf{r}) = E\psi(\mathbf{r}) \quad (4.1.1)$$

subject to

$$\psi(\mathbf{r}) \sim e^{ikz} + f(\theta) \frac{e^{ikr}}{r}, \quad r \rightarrow \infty. \quad (4.1.2)$$

Make the **partial wave expansion**

$$\psi(\mathbf{r}) = \sum_{l=0}^{\infty} R_l(r) P_l(\cos \theta). \quad (4.1.3)$$

The Legendre polynomials, $P_l(u)$ satisfy

$$\frac{d}{du}(1-u^2) \frac{d}{du} P_l(u) + l(l+1) P_l(u) = 0, \quad (4.1.4)$$

and are **angular momentum** wavefunctions; this PDE is simply

$$\mathbf{L}^2 P_l = \hbar^2 l(l+1) P_l. \quad (4.1.5)$$

Then Schrödinger's equation is

$$\frac{d^2}{dr^2}(rR_l) + \left(k^2 - \frac{l(l+1)}{r^2} - U(r) \right) rR_l = 0, \quad (4.1.6)$$

where

$$E = \frac{\hbar^2 k^2}{2m}, \quad U(r) = \frac{2m}{\hbar^2} V(r). \quad (4.1.7)$$

For a short-range potential (the only kind we shall consider for the time being) as $r \rightarrow \infty$ we get

$$\frac{d^2}{dr^2}(rR_l) + k^2(rR_l) = 0. \quad (4.1.8)$$

This equation has two independent solutions for $R_l(r)$:

$$\frac{e^{-ikr}}{r} \quad \text{and} \quad \frac{e^{ikr}}{r}, \quad (4.1.9)$$

i.e., respectively, **ingoing** and **outgoing** spherical waves. These are the 3D analogues of the ingoing and outgoing plane waves in the 1D case.

4.1.1 Partial wave expansion for e^{ikz}

When $U = 0$, $\psi = e^{ikz} \equiv e^{ikr \cos \theta}$ is also a solution, and the corresponding radial equation $\forall r$ is

$$\frac{d^2}{d\rho^2}(\rho R_l) + \left(1 - \frac{l(l+1)}{\rho^2}\right) \rho R_l = 0, \quad (4.1.1.1)$$

with $\rho = kr$. Thus can write

$$e^{ikr \cos \theta} = \sum_l (2l+1) u_l(kr) P_l(\cos \theta), \quad (4.1.1.2)$$

where the factor of $(2l+1)$ is for convenience, and $u_l(\rho)$ satisfies eqn (4.1.1.1). Now

$$\int_{-1}^1 P_l(u) P_m(u) du = \frac{2}{(2l+1)} \delta_{lm}, \quad (4.1.1.3)$$

and hence

$$2u_l(\rho) = \int_{-1}^1 e^{i\rho u} P_l(u) du. \quad (4.1.1.4)$$

$\rho \rightarrow \infty$

Integrate by parts:

$$2u_l(\rho) = \left[\frac{e^{i\rho u} P_l(u)}{i\rho} \right]_{-1}^1 - \frac{1}{i\rho} \int_{-1}^1 e^{i\rho u} P_l'(u) du. \quad (4.1.1.5)$$

Have $P_l(1) = 1$, $P_l(-1) = (-1)^l$ and so

$$u_l(\rho) = \frac{e^{i\rho} - (-1)^l e^{-i\rho}}{2i\rho} + O(\rho^{-2}), \quad (4.1.1.6)$$

where a further integration by parts shows that the integral is $O(\rho^{-2})$. This may be rewritten as

$$u_l(\rho) \sim i^l \frac{\sin\left(\rho - \frac{1}{2}l\pi\right)}{\rho} \quad \rho \rightarrow \infty. \quad (4.1.1.7)$$

Then for $\rho \rightarrow \infty$

$$e^{ikz} = \sum_{l=0}^{\infty} (2l+1) i^l \frac{\sin\left(kr - \frac{1}{2}l\pi\right)}{kr} P_l(\cos\theta). \quad (4.1.1.8)$$

$\rho \rightarrow 0$

Since $P_n(u)$ is a polynomial of degree n we can write the monomial

$$u^l = \frac{l!}{(2l-1)!!} P_l(u) + \sum_{m<l} c_m P_m(u). \quad (4.1.1.9)$$

Then

$$\begin{aligned} 2u_l(\rho) &= \int_{-1}^1 \underbrace{\left(1 + \dots + \frac{(i\rho u)^l}{l!} + \dots\right)}_{\exp(i\rho u)} P_l(u) du \\ &= \frac{(i\rho)^l}{l!} \frac{2l!}{(2l+1)!!} + O(\rho^{l+2}) \implies u_l(\rho) \sim \frac{i^l \rho^l}{(2l+1)!!} \implies \\ e^{ikz} &\sim \sum_{l=0}^{\infty} \frac{i^l (kr)^l}{(2l-1)!!} P_l(\cos\theta). \end{aligned} \quad (4.1.1.10)$$

The solutions to eqn. (4.1.1.1) are the **spherical Bessel functions** $j_l(\rho), n_l(\rho)$ with $j_l(\rho)$ regular at $\rho = 0$. From the previous analysis we identify $u_l(\rho) = i^l j_l(\rho)$ which **defines** $j_l(\rho)$.

Because there is no first-order term in eqn. (4.1.1.1) the Wronskian is a constant and we define $W(\rho j_l(\rho), \rho n_l(\rho)) = 1$. This determines $n_l(\rho)$ and its asymptotic behaviour. We then have

$\rho \rightarrow \infty$

$$j_l(\rho) \sim \frac{\sin\left(\rho - \frac{1}{2}l\pi\right)}{\rho}, \quad n_l(\rho) \sim -\frac{\cos\left(\rho - \frac{1}{2}l\pi\right)}{\rho}. \quad (4.1.1.11)$$

$\rho \rightarrow 0$

$$j_l(\rho) \sim \frac{\rho^l}{(2l+1)!!}, \quad n_l(\rho) \sim -(2l-1)!! \rho^{-(l+1)}. \quad (4.1.1.12)$$

The full solutions are

$$j_l(x) = (-x)^l \left(\frac{1}{x} \frac{d}{dx}\right)^l \frac{\sin x}{x}, \quad n_l(x) = -(-x)^l \left(\frac{1}{x} \frac{d}{dx}\right)^l \frac{\cos x}{x}. \quad (4.1.1.13)$$

In particular,

$$\begin{aligned} j_0(x) &= \frac{\sin x}{x}, & j_1(x) &= \frac{\sin x}{x^2} - \frac{\cos x}{x}, \\ n_0(x) &= -\frac{\cos x}{x}, & n_1(x) &= -\frac{\cos x}{x^2} - \frac{\sin x}{x}. \end{aligned} \quad (4.1.1.14)$$

4.1.2 Partial wave expansion for scattering states

For $U(r) = 0$ there is no scattering and for $r \rightarrow \infty$ we have

$$e^{ikz} \sim \sum_{l=0}^{\infty} \frac{2l+1}{2ik} \left[\frac{e^{ikr}}{r} - (-1)^l \frac{e^{-ikr}}{r} \right] P_l(\cos \theta). \quad (4.2.1.1)$$

In a given summand the first(second) term is an **outgoing(ingoing)** spherical wave of angular momentum l ; these are the partial waves each labelled by l . They are the 3D analogues of the parity partial waves in 1D scattering. We can view the plane wave as a superposition of **ingoing** and **outgoing** spherical waves.

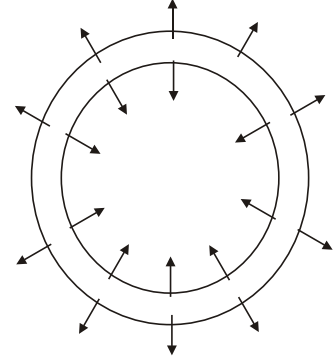

The waves **interfere** to produce the unscattered beam. For each l we see an ingoing spherical wave which passes through the origin and emerges as an outgoing spherical wave; it is analogous to sum of the parity ingoing and outgoing waves of given parity in 1D.

For $U(r) \neq 0$ there is scattering:

- (i) We expect only the outgoing waves to be modified; the ingoing waves have not yet encountered the target.
- (ii) Since l is a good quantum number it is not changed by the scattering; each **partial wave** scatters **independently**.
- (iii) Conservation of probability (particle number) implies that each outgoing wave of given l is modified by a **phase** only. This is identical to the situation with the symmetric potential in 1D.

Thus expect, as $r \rightarrow \infty$,

$$\begin{aligned} \psi(\mathbf{r}) &\sim \sum_{l=0}^{\infty} \frac{2l+1}{2ik} \left[e^{2i\delta_l} \frac{e^{ikr}}{r} - (-1)^l \frac{e^{-ikr}}{r} \right] P_l(\cos \theta) \\ &= e^{ikz} + \sum_{l=0}^{\infty} \left(\frac{2l+1}{2ik} \right) (e^{2i\delta_l} - 1) P_l(\cos \theta) \frac{e^{ikr}}{r}. \end{aligned} \quad (4.2.1.2)$$

Note here that the S-matrix, \mathbf{S} , has entries $S_{l'l'}$ for a general potential but that in the spherically symmetric case it is diagonal as is, therefore, the T-matrix $\mathbf{T} = \mathbf{S} - \mathbb{I}$:

$$S_{l'l'} = e^{2i\delta_l} \delta_{l'l'}, \quad T_{l'l'} = (e^{2i\delta_l} - 1) \delta_{l'l'}, \quad (4.2.1.3)$$

where δ_l is a function of k . By comparing with eqn. (4.2) we identify the scattering amplitude

$$f(\theta) = \frac{1}{k} \sum_{l=0}^{\infty} (2l+1) f_l P_l(\cos \theta), \quad f_l = e^{i\delta_l} \sin \delta_l. \quad (4.2.1.4)$$

The f_l are the **partial wave** scattering amplitudes. From eqn. (4.7) we have

$$\frac{d\sigma}{d\Omega} = \frac{1}{k^2} \sum_{l,l'} (2l+1)(2l'+1) f_l f_{l'}^* P_l(\cos \theta) P_{l'}(\cos \theta) \implies \quad (4.2.1.5)$$

$$\sigma = \frac{4\pi}{k^2} \sum_l (2l+1) \sin^2 \delta_l. \quad (4.2.1.6)$$

4.1.3 The optical theorem

From eqn. (4.2.1.4) we see immediately that

$$\text{Im } f(0) = \frac{1}{k} \sum_l (2l+1) \sin^2 \delta_l. \quad (4.3.1.1)$$

Thus, we obtain the **optical theorem**

$$\sigma = \frac{4\pi}{k} \text{Im } f(0). \quad (4.3.1.2)$$

4.1.4 Solving for the asymptotic scattered wave

From eqn. (4.2.1.2), for $r \rightarrow \infty$

$$\psi(\mathbf{r}) \sim \sum_{l=0}^{\infty} \frac{(2l+1)}{2ik} e^{i\delta_l} \frac{\sin(kr - \frac{1}{2}l\pi + \delta_l)}{kr} P_l(\cos \theta). \quad (4.4.1.1)$$

The task is to solve the Schrödinger equation, identify this asymptotic form and hence calculate the δ_l . Must therefore solve

$$\frac{d^2}{dr^2}(rR_l) + \left(k^2 - \frac{l(l+1)}{r^2} - U(r) \right) rR_l = 0, \quad (4.4.1.2)$$

where $U(r) = 2mV(r)/\hbar^2$, with boundary conditions that

- (i) $R_l(r)$ is regular at $r = 0$;
- (ii) $rR_l(r) \sim B_l \sin(kr - \frac{1}{2}l\pi + \delta_l)$ as $r \rightarrow \infty$.

We suppose that $V(r)$ is negligible beyond a finite range $r = a$ (in our examples we shall choose it to be zero for large enough r), although the formalism is fine as long as $V \rightarrow 0$ faster than $1/r$ as $r \rightarrow \infty$. We note the asymptotic behaviours of the spherical Bessel functions $j_l(r)$ and $n_l(r)$ discussed earlier, see eqn. (4.1.1.11). Then for $r > a$ we will have

$$R_l(r) = B_l (j_l(\rho) \cos \delta_l(k) - n_l(\rho) \sin \delta_l(k)). \quad (4.4.1.3)$$

The boundary condition is that $R_l(r)$ and $dR_l(r)/dr$ are continuous at $r = a$. Solve the Schrödinger equation

$$\frac{d^2}{dr^2}(rR_l) + \left(k^2 - \frac{l(l+1)}{r^2} - U(r) \right) rR_l = 0, \quad (4.4.1.4)$$

for $r < a$ and $U = 2mV/\hbar^2$. Define $\gamma_l(ka) = aR_l'(a)/R_l(a)$ for $r - a = 0^-$ (i.e., just inside the well): this is the logarithmic derivative and is dimensionless. Then the matching condition is

$$\frac{ka(j_l'(ka) \cos \delta_l - n_l'(ka) \sin \delta_l)}{j_l(ka) \cos \delta_l - n_l(ka) \sin \delta_l} = \gamma_l(ka) \implies \quad (4.4.1.5)$$

$$\tan \delta_l(k) = \frac{\gamma_l(ka)j_l(ka) - ka j_l'(ka)}{\gamma_l(ka)n_l(ka) - ka n_l'(ka)}. \quad (4.4.1.6)$$

If $V(r)$ does not vanish for $r > a$ then eqn. (4.4.1.4) must be solved for two solutions which behave as $r \rightarrow \infty$, respectively, as ingoing and outgoing spherical waves. The solution for $\psi(\mathbf{r})$ will be a linear combination of the two solutions whose boundary condition is that it behaves asymptotically as in eqn. (4.2.1.2). Then can determine the phase-shifts $\delta_l(k)$.

4.1.5 Low-energy scattering

In the low energy limit we take k small. By this mean, for example, $ka \rightarrow 0$. In this limit we expect $\gamma_l(ka) \rightarrow \text{constant}$ and in eqn. (4.4.1.6) we can replace the Bessel functions by their approximate behaviour for small argument (see eqn. (4.1.1.12))

$$j_l(x) \sim x^l, \quad n_l(x) \sim x^{-(l+1)} \implies \tan \delta_l(k) \sim (ka)^{2l+1}. \quad (4.5.1.1)$$

We thus deduce that

$$\delta_l(k) \sim (ka)^{2l+1}(1 + O(k^2)) \quad (4.5.1.2)$$

It is instructive to understand physically why behaviour of this sort is to be expected. In eqn. (4.4.1.4) the potential is made up of two pieces: $U(r)$ and the centrifugal barrier $-l(l+1)/r^2$ which acts to **repel** penetration of the particle to the origin where $U(r)$ is appreciable. For low energy $E \sim k^2$ the particle simply does not have enough energy to tunnel significantly to the region where it encounters $U(r)$ and so the scattering is weak and weakens as l increases.

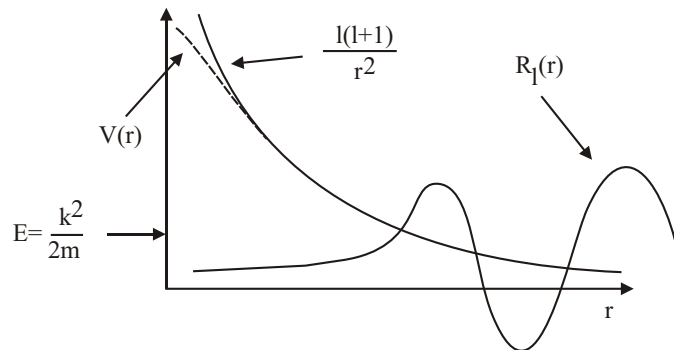

Another way to see this from a classical perspective is that the angular momentum is $\hbar k b$ where b is the impact parameter. Then, $l \sim kb \implies b \sim l/k$, and b is related to the closest distance of approach. If $b > a$ then the particle never (classically) enters the region of influence of $V(r)$ and does not scatter; this corresponds to $ka < l$.

For small k the $l = 0$, S-wave, contribution is the only one that is not negligible and its contribution dominates the cross-section. We write

$$\delta_0 = -a_s k + O(k^3), \quad (4.5.1.3)$$

and from the formula for σ , eqn. (4.2.1.6), we find that the low-energy cross-section is

$$\sigma \approx \sigma_0 = 4\pi a_s^2. \quad (4.5.1.4)$$

a_s is called **the scattering length** and can be positive, negative and under certain circumstances it can diverge as a function of parameters in the potential.

We must have $rR_0(r) \rightarrow 0$ as $r \rightarrow 0$, and for $r > a$ we have (exactly)

$$R_0(r) = B_0 \left(\frac{e^{i(kr - 2ka_s)}}{r} - \frac{e^{-ikr}}{r} \right). \quad (4.5.1.5)$$

Clearly, this function has a zero at $r = a_s$. So $rR_0(r)$ looks like

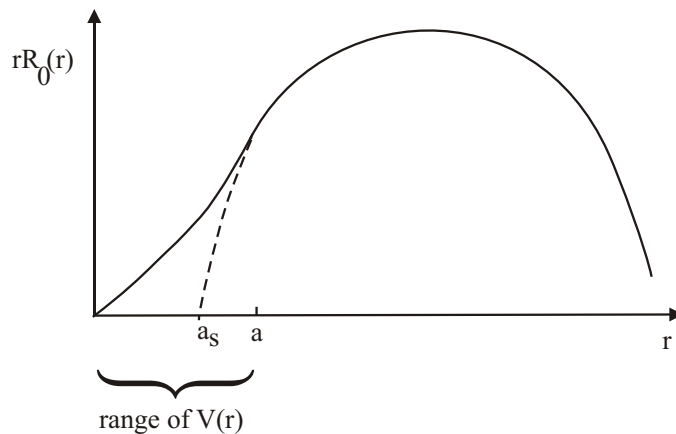

This shows that the sign of a_s is related to the curvature of the wavefunction inside $r < a$.

4.2 Examples

1. Scattering off a hard sphere.

The potential is

$$U(r) = \begin{cases} \infty & r < a, \\ 0 & r > a, \end{cases} \quad (4.2.1)$$

with boundary conditions

$$\psi(r) = \begin{cases} 0 & r \leq a \\ \text{continuous} & r = a. \end{cases} \quad (4.2.2)$$

For $r > a$, $R_l(r)$ takes the form in eqn. (4.4.1.3) and so the boundary condition at $r = a$ means

$$R_l(a) = B_l (j_l(ka) \cos \delta_l - n_l(ka) \sin \delta_l) = 0 \quad \Longrightarrow \quad \tan \delta_l = \frac{j_l(ka)}{n_l(ka)}. \quad (4.2.3)$$

This determines the δ_l and hence $d\sigma/d\Omega$.

For long wavelengths $ka \ll 1$ and then find

$$\delta_l(k) \approx -\frac{(ka)^{2l+1}}{(2l+1)!!(2l-1)!!}, \quad (4.2.4)$$

with the **exact** result

$$\delta_0 = -ka. \quad (4.2.5)$$

Note that we have chosen $\delta(0) = 0$ but, of course, $\tan \delta = 0$ has solutions $\delta = n\pi$ and the choice is a matter of convention. Thus, for $k \rightarrow 0$

$$\begin{aligned} f(\theta) &\approx \sum_l \frac{(2l+1)}{k} \delta_l P_l(\cos \theta) \\ &= -\sum_l \frac{k^{2l} a^{2l+1}}{[(2l-1)!!]^2} P_l(\cos \theta) \\ &= -a - k^2 a^3 \cos \theta + O(k^4). \end{aligned} \quad (4.2.6)$$

From eqn. (4.2.5) we see that the scattering length is $a_s = a$ and therefore that the low-energy cross-section is $\sigma = 4\pi a^2$. This is to be compared with the classical result derived earlier of $\sigma = \pi a^2$. The increase is due to diffraction effects.

1. S-wave scattering on a square well.

$$V(r) = \begin{cases} -V_0 & r < a \\ 0 & r > a. \end{cases} \quad U(r) = \frac{2mV(r)}{\hbar^2}, \quad \gamma^2 = \frac{2mV_0}{\hbar^2}. \quad (4.2.7)$$

For $l = 0$ have wavefunction $\psi(r) = u(r)/r$ where the radial Schrödinger equation is

$$u'' + k^2 u = 0 \quad r > a, \quad (4.2.8)$$

$$u'' + \kappa^2 u = 0 \quad r < a, \quad (4.2.9)$$

$$E = \frac{\hbar^2 k^2}{2m} \quad \kappa^2 = k^2 + \gamma^2. \quad (4.2.10)$$

$r < a$: $\psi(r)$ regular at origin $\Longrightarrow u(r) = A \sin \kappa r$.

$r > a$: $u(r) = B \sin(kr + \delta_0)$ where δ_0 is the S-wave ($l = 0$) phase shift.

The boundary condition is that $\frac{1}{\psi} \frac{d\psi}{dr}$, or equivalently $\frac{1}{u} \frac{du}{dr}$, is continuous at $r = a$.

This gives

$$\begin{aligned} \frac{A \kappa \cos \kappa a}{A \sin \kappa a} &= \frac{B k \cos(ka + \delta_0)}{B \sin(ka + \delta_0)} \quad \Longrightarrow \\ \kappa \cot \kappa a &= k \cot(ka + \delta_0) \quad \text{or} \\ \frac{\tan(ka + \delta_0)}{ka} &= \frac{\tan \kappa a}{\kappa a}. \end{aligned} \quad (4.2.11)$$

$k \rightarrow 0$

$$\begin{aligned} \tan(ka + \delta_0) &\approx \frac{k}{\gamma \cot \gamma a} \\ \frac{\tan ka + \tan \delta_0}{1 + \tan ka \tan \delta_0} &\approx \frac{k}{\gamma \cot \gamma a} \implies \\ \tan \delta_0 &\approx \frac{ka(1 - \gamma a \cot \gamma a)}{\gamma a \cot \gamma a} + O(k^3). \end{aligned} \quad (4.2.12)$$

Then

$$\delta_0 = -a_s k + O(k^3) \quad (4.2.13)$$

gives

$$a_s = -\frac{(1 - \gamma a \cot \gamma a)}{\gamma a \cot \gamma a} a. \quad (4.2.14)$$

for the scattering length, with $\sigma \approx 4\pi a_s^2$.

4.2.1 Higher partial waves in the square well

We use the theory developed in section 4.1.4. We need to compute $\gamma_l = R_l'(a)/R_l(a)$ for the wavefunction in the well to perform the matching given in eqn. (4.4.1.6). The radial Schrödinger equation in the well, $r < a$, is

$$(rR_l)'' + \left(k^2 - \frac{l(l+1)}{r^2}\right)(rR_l) = 0, \quad (4.1.2.1)$$

and the solution is $R_l(r) = A j_l(\kappa r)$ since $R_l \rightarrow 0$ as $r \rightarrow 0$. Then the matching condition from eqn. (4.4.1.6) is

$$\tan \delta_l(k) = \frac{\gamma_l(ka)j_l(ka) - ka j_l'(ka)}{\gamma_l(ka)n_l(ka) - ka n_l'(ka)}, \quad \gamma_l = \frac{\kappa a j_l'(\kappa a)}{j_l(\kappa a)}. \quad (4.1.2.2)$$

As $k \rightarrow 0$ have $\gamma_l \rightarrow \text{const}$, $j_l(ka) \sim (ka)^l$, $n_l(ka) \sim (ka)^{-(l+1)}$ and, as before, get $\delta_l \sim (ka)^{2l+1}$. Thus the contribution to the cross-section at low k from the l -th partial wave is

$$\sigma_l \sim \frac{\sin^2 \delta_l}{k^2} \sim k^{4l}. \quad (4.1.2.3)$$

4.3 Influence of bound states

Solve for the bound states in the square well:

$$u(r) = \begin{cases} A \sin \kappa r & r < a \\ B e^{-\alpha r} & r > a \end{cases} \quad \alpha > 0 \quad (4.3.1)$$

Find the usual condition

$$-\kappa a \cot \kappa a = \alpha a = (\gamma^2 a^2 - \kappa^2 a^2)^{1/2} \quad \text{with} \quad E = -\frac{\hbar^2 \alpha^2}{2m}. \quad (4.3.2)$$

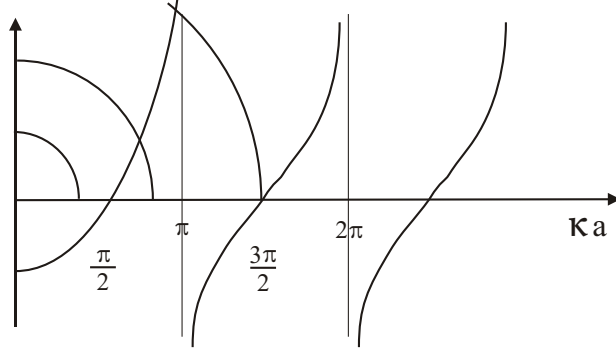

A new bound state appears whenever $\gamma a = (n + \frac{1}{2})\pi$ where $\cot \gamma a = 0$, and then for $\gamma a = (n + \frac{1}{2})\pi \pm \varepsilon$, $\varepsilon > 0$

$$a_s = -\frac{(1 - \gamma a \cot \gamma a)}{\gamma a \cot \gamma a} a \xrightarrow{\varepsilon \rightarrow 0} \pm \infty. \quad (4.3.3)$$

- (i) a_s large and **negative**: new bound state not quite appeared;
- (ii) a_s large and **positive**: new, weakly bound, state has just appeared;
- (iii) $\tan \delta_0 \rightarrow \pm \infty \implies \delta_0 = (n + \frac{1}{2})\pi$. Thus, in both cases get a maximum contribution to σ from $l = 0$:

$$\sigma_0 = 4\pi/k^2. \quad (4.3.4)$$

Now

$$\begin{aligned} \tan(ka + \delta_0) &= \frac{ka}{\kappa a \cot \kappa a} \equiv f(k) \implies \\ S_0 &= e^{2i\delta_0} = e^{-2ika} \frac{1 + if(k)}{1 - if(k)}. \end{aligned} \quad (4.3.5)$$

S_0 is the diagonal entry in the S-matrix for $l = 0$. Thus S_0 has a **pole** when $f(k) = -i$ and has the associated **zero** at $f(k) = i$. Write $k = i\alpha$, $\alpha > 0$, and then value of α at the pole is given by the bound state formula eqn. (4.3.2). As in 1D, corresponding to each bound state, the S-matrix has a pole on the positive imaginary axis and associated zero on the negative imaginary axis for complex k .

A simple model for S is

$$S(k) = \frac{i\alpha + k}{i\alpha - k} = e^{2i\delta_0}. \quad (4.3.6)$$

Then for $k \rightarrow 0$ find $\delta_0 \approx -a_s k$ with $a_s = 1/\alpha$.

If α is small and **negative** then the well is not quite deep enough for a new bound state to appear (need $\alpha > 0$ for exponential decay as $|x| \rightarrow \infty$) and a_s is large and **negative**.

If α small and **positive** then have bound state near top of well and a_s large and **positive**;

In either case the S-wave cross-section is very big: $\sigma_0 \sim 4\pi a_s^2$. An example is low energy proton-neutron scattering where the deuteron (n-p) bound state is only lightly bound.

4.4 Resonance Poles

As in the example in 1D scattering, the S-matrix can have poles at complex energies which correspond to quasistable states or resonances. The pole will be at $E = E_0 - i\frac{1}{2}\Gamma$ and the state has the properties:

- (i) it was prepared by some mechanism at a time far in the past when the particle was localized inside a high potential barrier. In $D > 1$ this barrier can be created by the angular momentum term in the radial wave equation for $l \neq 0$, where the effective potential is (see eqn. (4.4.1.4))

$$W(r) = \underbrace{\frac{l(l+1)}{r^2}}_{\text{centrifugal barrier}} + U(r). \quad (4.4.1)$$

For a nucleus the potential $U(r)$ is short-range and strongly attractive whereas the centrifugal barrier is repulsive. Then $W(r)$ looks like

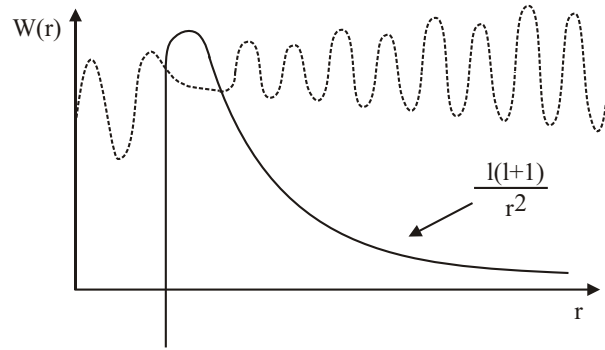

- (ii) the state is not a stationary state and so the particle tunnels through the barrier and “leaks” out to ∞ as an outgoing spherical wave;
- (iii) The time-dependence of the state at fixed x , and especially inside the barrier, is

$$e^{-iE_0 t} e^{-\frac{1}{2}\Gamma t} \quad (4.4.2)$$

giving a decay-rate Γ for the probability of finding the particle at any fixed x ;

- (iv) These states can also be excited quark-model states in the scattering of two elementary particles or excited atomic states in the scattering of an electron on an atom.

Then

$$S(E) = e^{2i\delta} = \frac{E - E_0 - i\frac{1}{2}\Gamma}{E - E_0 + i\frac{1}{2}\Gamma} \quad (4.4.3)$$

and so

$$\begin{aligned} \cos 2\delta &= \frac{(E - E_0)^2 - \frac{1}{4}\Gamma^2}{(E - E_0)^2 + \frac{1}{4}\Gamma^2} \implies \\ \sin \delta &= \frac{\Gamma}{\sqrt{4(E - E_0)^2 + \Gamma^2}} \implies \sigma \approx \frac{4\pi}{k^2} \frac{\Gamma^2}{4(E - E_0)^2 + \Gamma^2} \end{aligned} \quad (4.4.4)$$

The cross-section has a bump at $E = E_0$ of width $\Gamma/2$ much like a damped harmonic oscillator near to the resonant frequency.

Note that $\delta(E) = (n + 1/2)\pi$ and, as E increases, each time E “passes through” a resonance then n increases by unity. This is how resonances and excited states are detected.

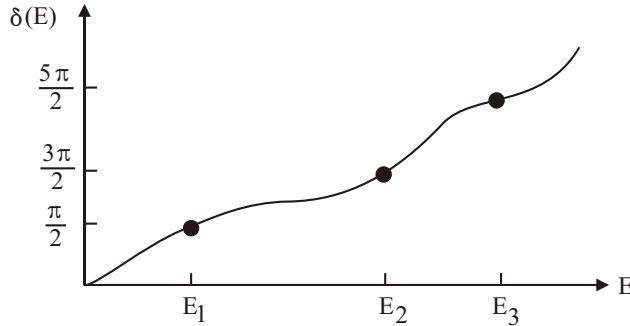

An argand plot of the partial wave amplitude $f_l(E) = e^{i\delta(E)} \sin \delta(E)$ vs E is a circle of unit radius centre $0.5i$. Here is a plot showing recent experimental P-wave ($l = 1$) data. The first time the curve is on the **unitarity** circle and is the Δ resonance of mass 1230MeV. For other trajectories probability has “leaked” away into undetected channels and so are within the circle but can still pinpoint $\delta_1 = (n + 1/2)\pi$ in each case. It is rather messy in real life, though.

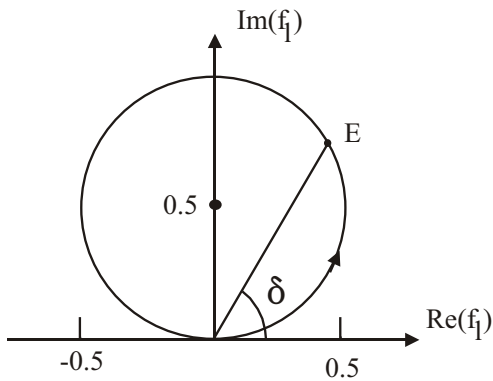

terminations.

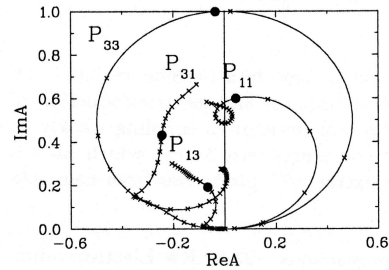

Fig. 2. Argand plots for P-partial-wave amplitudes from threshold (1080 MeV) to $W = 2.5$ GeV.

Fig. 2

4.5 Green’s Functions

Use the **Green function** to analyse scattering processes. Will look for scattering state solutions to the Schrödinger equation

$$\left(-\frac{\hbar^2}{2m}\nabla^2 + V(\mathbf{r})\right)\psi(\mathbf{r}) = E\psi(\mathbf{r}). \tag{4.5.1}$$

Then

$$(\nabla^2 + k^2)\psi(\mathbf{r}) = U(\mathbf{r})\psi(\mathbf{r}), \quad U(\mathbf{r}) = \frac{2m}{\hbar^2}V(\mathbf{r}), \quad E = \frac{\hbar^2 k^2}{2m}. \tag{4.5.2}$$

Define the **free** or **non-interacting** Green function G_0 by

$$(\nabla^2 + k^2) G_0(k; \mathbf{r}, \mathbf{r}') = \delta(\mathbf{r} - \mathbf{r}') . \quad (4.5.3)$$

By translation invariance we have $G_0(k; \mathbf{r}, \mathbf{r}') = G_0(k; \mathbf{r} - \mathbf{r}')$ and so can define the Fourier transform by

$$\begin{aligned} \tilde{G}_0(k; \mathbf{q}) &= \int d^3x e^{-i\mathbf{q} \cdot \mathbf{x}} G_0(k; \mathbf{x}) \implies \\ G_0(k; \mathbf{x}) &= \int \frac{d^3q}{(2\pi)^3} e^{i\mathbf{q} \cdot \mathbf{x}} \tilde{G}_0(k, \mathbf{q}) . \end{aligned} \quad (4.5.4)$$

Then eqn. (4.5.3) becomes

$$\begin{aligned} (-q^2 + k^2) \tilde{G}_0(k; \mathbf{q}) &= 1 \implies \\ \tilde{G}_0(k; \mathbf{q}) &= -\frac{1}{q^2 - k^2} , \end{aligned} \quad (4.5.5)$$

where $q^2 = |\mathbf{q}|^2$. Hence,

$$G_0(k; \mathbf{r} - \mathbf{r}') = - \int \frac{d^3q}{(2\pi)^3} \frac{e^{i\mathbf{q} \cdot (\mathbf{r} - \mathbf{r}')}}{q^2 - k^2} . \quad (4.5.6)$$

This is a singular integral because of the poles on the real axis at $q = k$. This problem is resolved by introducing $i\epsilon$ into the denominator, where $\epsilon > 0$ is infinitesimal. This is a choice of boundary condition for the Green function G_0 . [Remember that the Fourier transform of the Θ (or Heavyside) functions $\Theta(\pm t)$ differ simply by the sign of an ϵ in the denominator:

$$\Theta(\pm t) = \int \frac{d\omega}{2\pi} \frac{e^{i\omega t}}{i\omega \pm \epsilon} .$$

Then define

$$G_0^{(\pm)}(k; \mathbf{r} - \mathbf{r}') = - \int \frac{d^3q}{(2\pi)^3} \frac{e^{i\mathbf{q} \cdot (\mathbf{r} - \mathbf{r}')}}{q^2 - k^2 \mp i\epsilon} . \quad (4.5.7)$$

We are making a choice of how we must complete the contour: whether in UHP or LHP. This is determined by Jordan's lemma (remember $\Theta(\pm t)$ example). We get that

$$G_0^{(\pm)}(k; \mathbf{r} - \mathbf{r}') = -\frac{1}{4\pi} \frac{e^{\pm ik|\mathbf{r} - \mathbf{r}'|}}{|\mathbf{r} - \mathbf{r}'|} . \quad (4.5.8)$$

The ambiguity occurs because we had not specified the **boundary conditions** G_0 must have. For scattering theory we require solutions with **outgoing** spherical waves and so choose $G_0^{(+)}$.

Check:

For $R \neq 0$

$$\nabla^2 \frac{e^{ikR}}{R} = \frac{1}{R} \frac{d^2}{dR^2} R \frac{e^{ikR}}{R} = -k^2 \frac{e^{ikR}}{R} \implies (\nabla^2 + k^2) \frac{e^{ikR}}{R} = 0 . \quad (4.5.9)$$

At $R = 0$ have the usual result:

$$\nabla^2 \frac{1}{R} = -4\pi\delta(\mathbf{R}) . \quad (4.5.10)$$

So, putting the two together we get

$$(\nabla^2 + k^2) \frac{e^{ikR}}{R} = -4\pi\delta(\mathbf{R}) . \quad (4.5.11)$$

Can also use divergence theorem for sphere of infinitesimal radius about the origin.

4.5.1 Integral equations

Using $G_0^{(+)}$ we can replace the Schrödinger p.d.e together with the boundary conditions by a single integral equation which automatically incorporates the boundary conditions. We write eqn. (4.5.2) as

$$\psi(\mathbf{k}; \mathbf{r}) = \underbrace{e^{i\mathbf{k} \cdot \mathbf{r}}}_{\text{homog. soln.}} + \underbrace{\int d^3r' G_0^{(+)}(\mathbf{k}; \mathbf{r} - \mathbf{r}') U(\mathbf{r}') \psi(\mathbf{k}; \mathbf{r}')}_{\text{particular integral}} \quad (4.1.5.1)$$

Check:

$$\begin{aligned} (\nabla^2 + k^2)\psi(\mathbf{k}; \mathbf{r}) &= 0 + \int d^3r' \delta(\mathbf{r} - \mathbf{r}') U(\mathbf{r}') \psi(\mathbf{k}; \mathbf{r}') \\ &= U(\mathbf{r}) \psi(\mathbf{k}; \mathbf{r}) . \quad QED \end{aligned} \quad (4.1.5.2)$$

Now $\psi(\mathbf{k}; \mathbf{r})$ takes the form of the required scattering solution, namely

$$\psi(\mathbf{k}; \mathbf{r}) = e^{i\mathbf{k} \cdot \mathbf{r}} + \text{outgoing waves} . \quad (4.1.5.3)$$

To see this consider $\mathbf{r} \rightarrow \infty$ such that $|\mathbf{r}| \gg |\mathbf{r}'|$. Can always do this if $U(\mathbf{r}')$ vanishes sufficiently fast as $\mathbf{r}' \rightarrow \infty$. Then we can expand under the integral sign. Have

$$|\mathbf{r} - \mathbf{r}'| = (r^2 + r'^2 - 2\mathbf{r} \cdot \mathbf{r}')^{1/2} \approx r - \hat{\mathbf{r}} \cdot \mathbf{r}' . \quad (4.1.5.4)$$

Define $\mathbf{k}' = k\hat{\mathbf{r}}$, and then

$$G_0^{(+)} \approx -\frac{1}{4\pi} \frac{e^{ikr}}{r} e^{-i\mathbf{k}' \cdot \mathbf{r}'} , \quad (4.1.5.5)$$

and so

$$\psi(\mathbf{k}; \mathbf{r}) \approx e^{i\mathbf{k} \cdot \mathbf{r}} - \frac{1}{4\pi} \frac{e^{ikr}}{r} \int d^3r' e^{-i\mathbf{k}' \cdot \mathbf{r}'} U(\mathbf{r}') \psi(\mathbf{k}; \mathbf{r}') . \quad (4.1.5.6)$$

Comparing with earlier definition in eqn. (4.2) we identify the scattering amplitude as

$$f(\mathbf{k}, \mathbf{k}') = -\frac{1}{4\pi} \int d^3r' e^{-i\mathbf{k}' \cdot \mathbf{r}'} U(\mathbf{r}') \psi(\mathbf{k}; \mathbf{r}') , \quad (4.1.5.7)$$

where $\mathbf{k} \cdot \mathbf{k}' = k^2 \cos \theta$ (i.e., $\mathbf{k} \cdot \mathbf{r} = kr \cos \theta$ and $\mathbf{k}' = k\hat{\mathbf{r}}$.)

4.5.2 The Born series

Solve the integral equation by iteration

$$\psi(\mathbf{k}; \mathbf{r}) = e^{i\mathbf{k} \cdot \mathbf{r}} + \int d^3r' G_0^{(+)}(k; \mathbf{r} - \mathbf{r}') U(\mathbf{r}') \psi(\mathbf{k}; \mathbf{r}'). \quad (4.2.5.1)$$

Define

$$\phi_{n+1}(\mathbf{r}) = \int d^3r' G_0^{(+)}(k; \mathbf{r} - \mathbf{r}') U(\mathbf{r}') \phi_n(\mathbf{r}'), \quad \text{with } \phi_0(\mathbf{r}) = e^{i\mathbf{k} \cdot \mathbf{r}}. \quad (4.2.5.2)$$

Then the formal solution is

$$\psi(\mathbf{k}; \mathbf{r}) = \sum_{n=0}^{\infty} \phi_n(\mathbf{r}). \quad (4.2.5.3)$$

This is the **Born series** for the wavefunction. Then have

$$f(\mathbf{k}, \mathbf{k}') = -\frac{1}{4\pi} \sum_n \int d^3r' e^{-i\mathbf{k}' \cdot \mathbf{r}'} U(\mathbf{r}') \phi_n(\mathbf{r}'). \quad (4.2.5.4)$$

In compressed notation the iterated series has the form

$$\begin{aligned} \psi &= \phi_0 + \int G_0 U \phi_0 + \int \int G_0 U G_0 U \phi_0 + \int \int \int G_0 U G_0 U G_0 U \phi_0 + \\ &\dots + \left(\int \dots \int G_0 \dots U \phi_0 \right) + \dots \end{aligned} \quad (4.2.5.5)$$

The integrals are convolutions of the form explicitly shown above (I have dropped the "+" on G_0 for ease of notation).

The **Born approximation** consists of keeping just the $n = 0$ term:

$$\begin{aligned} f_0(\mathbf{k}, \mathbf{k}') &= -\frac{1}{4\pi} \int d^3r' e^{-i\mathbf{k}' \cdot \mathbf{r}'} U(\mathbf{r}') e^{i\mathbf{k} \cdot \mathbf{r}'} \\ &= -\frac{1}{4\pi} \tilde{U}(\mathbf{k}' - \mathbf{k}) \equiv -\frac{m}{2\pi\hbar^2} \tilde{V}(\mathbf{k}' - \mathbf{k}). \end{aligned} \quad (4.2.5.6)$$

This gives the differential scattering cross-section

$$\frac{d\sigma}{d\Omega} \approx |f_0|^2 = \left(\frac{m}{2\pi\hbar^2} \right)^2 |\tilde{V}(\mathbf{k}' - \mathbf{k})|^2. \quad (4.2.5.7)$$

The next approximation is

$$\begin{aligned} f_1(\mathbf{k}, \mathbf{k}') &= -\frac{1}{4\pi} \int d^3r' e^{-i\mathbf{k}' \cdot \mathbf{r}'} U(\mathbf{r}') \int d^3r'' G_0(\mathbf{k}; \mathbf{r}' - \mathbf{r}'') U(\mathbf{r}'') e^{i\mathbf{k} \cdot \mathbf{r}''} \\ &= -\frac{1}{4\pi} \int \frac{d^3q}{(2\pi)^3} \int d^3r' e^{-i(\mathbf{k}' - \mathbf{q}) \cdot \mathbf{r}'} U(\mathbf{r}') \times \\ &\quad \frac{(-1)}{q^2 - k^2 - i\epsilon} \int d^3r'' e^{-i(\mathbf{q} - \mathbf{k}) \cdot \mathbf{r}''} U(\mathbf{r}'') \\ &= -\frac{1}{4\pi} \int \frac{d^3q}{(2\pi)^3} \tilde{U}(\mathbf{k}' - \mathbf{q}) \frac{(-1)}{q^2 - k^2 - i\epsilon} \tilde{U}(\mathbf{q} - \mathbf{k}). \end{aligned} \quad (4.2.5.8)$$

Can be extended to $f_n(\mathbf{k}, \mathbf{k}')$ and can give diagrammatic representation:

$$f(\mathbf{k}, \mathbf{k}') = \begin{array}{c} \begin{array}{c} \nearrow \mathbf{k}' \\ \searrow \mathbf{k} \\ \bullet \\ \uparrow \mathbf{k}' - \mathbf{k} \end{array} + \begin{array}{c} \nearrow \mathbf{k}' \\ \bullet \\ \leftarrow \mathbf{q} \\ \bullet \\ \leftarrow \mathbf{q} - \mathbf{k} \\ \bullet \\ \leftarrow \mathbf{q} \end{array} + \begin{array}{c} \nearrow \mathbf{k}' \\ \bullet \\ \leftarrow \mathbf{q}' \\ \bullet \\ \leftarrow \mathbf{q} \\ \bullet \\ \leftarrow \mathbf{q} \end{array} + \dots \end{array} \quad (4.2.5.9)$$

$$\begin{array}{c} \uparrow \mathbf{p} \\ \bullet \end{array} \quad \text{factor of } \tilde{U}(\mathbf{p}), \quad \begin{array}{c} \mathbf{q} \\ \leftarrow \bullet \end{array} \quad \text{factor of } \frac{-1}{q^2 - k^2 - i\epsilon}$$

$$\int \frac{d^3q}{(2\pi)^3} \quad \text{for each internal momentum } \mathbf{q}, \quad \text{and overall factor of } -\frac{1}{4\pi}.$$

This is similar to Feynman diagrams for perturbation theory. It is assumed that U is weak in some sense and so the series converges.

Example of Born approximation

Choose the Yukawa potential

$$V(\mathbf{r}) = \lambda \frac{e^{-\mu r}}{r} \implies \tilde{V}(\mathbf{q}) = \frac{4\pi\lambda}{q^2 + \mu^2}. \quad (4.2.5.10)$$

Here $1/\mu$ is the range of the force. We have

$$\mathbf{q} = \mathbf{k} - \mathbf{k}' \implies q^2 = 2k^2 - 2k^2 \cos \theta = \frac{4mE}{\hbar^2} (1 - \cos \theta), \quad (4.2.5.11)$$

and so

$$\tilde{V}(\mathbf{q}) = \frac{4\pi\hbar^2\lambda}{\hbar^2\mu^2 + 4mE(1 - \cos \theta)} = \frac{4\pi\hbar^2\lambda}{\hbar^2\mu^2 + 8mE(\sin \theta/2)^2}. \quad (4.2.5.12)$$

Using eqn. (4.2.5.7) we get

$$\begin{aligned} \frac{d\sigma}{d\Omega} &= \left(\frac{m}{2\pi\hbar^2} \right)^2 \frac{16\pi^2\hbar^4\lambda^2}{[\hbar^2\mu^2 + 8mE(\sin \theta/2)^2]^2} \\ &= \frac{4m^2\lambda^2}{[\hbar^2\mu^2 + 8mE(\sin \theta/2)^2]^2}. \end{aligned} \quad (4.2.5.13)$$

For Rutherford scattering on an electric charge e have $\mu = 0$, and $\lambda = e^2/4\pi\epsilon_0 \equiv \alpha\hbar c$ ($\alpha = 1/137$ is fine structure constant). So we get

$$\frac{d\sigma}{d\Omega} = \frac{\lambda^2}{16E^2(\sin \theta/2)^4} = \left(\frac{\alpha\hbar c}{4E} \right)^2 \frac{1}{(\sin \theta/2)^4}. \quad (4.2.5.14)$$

5 Periodic Structures

Many solids have crystalline structure: atoms are arranged in regular arrays, e.g. *NaCl*, metals, semiconductors such as silicon and germanium. The physical properties are determined by

- (i) the underlying periodic structure;
- (ii) impurities and small deviations from regularity;
- (iii) the motion of electrons through the crystal, e.g. the ability to conduct;
- (iv) the vibrations of atoms about their equilibrium positions in the periodic structure. The effects are strongly temperature dependent.

An example is the simple cubic lattice in any dimension. In 2D have

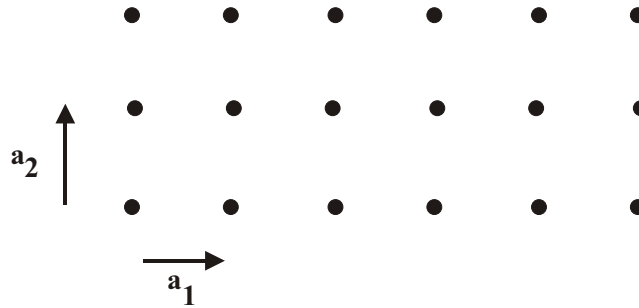

Arrays are not cubic in general but there always exists a regularity or periodicity. This means that there is a **discrete translation invariance**. We can find three, linearly independent, vectors $\mathbf{a}_1, \mathbf{a}_2, \mathbf{a}_3$ such that a displacement

$$\mathbf{r} \rightarrow \mathbf{r} + l_1\mathbf{a}_1 + l_2\mathbf{a}_2 + l_3\mathbf{a}_3, \quad l_1, l_2, l_3 \text{ integers } (l_i \in \mathbb{Z}) \quad (5.1)$$

leaves us in the same relation to the crystal as before. The choice of basis vectors \mathbf{a}_i is not unique:

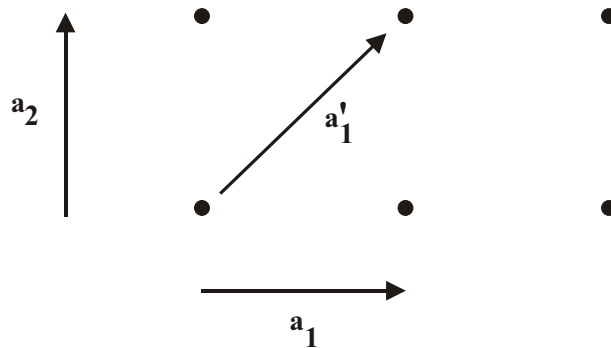

Can use $(\mathbf{a}_1, \mathbf{a}_2)$ or $(\mathbf{a}'_1, \mathbf{a}_2)$. A given choice is a choice of the **unit cell** for the lattice; the three vectors $\mathbf{a}_1, \mathbf{a}_2, \mathbf{a}_3$ lie along the edges of the unit cell. The lattice Λ is then

$$\Lambda = \{ \mathbf{l} : \mathbf{l} = l_1 \mathbf{a}_1 + l_2 \mathbf{a}_2 + l_3 \mathbf{a}_3 \quad l_i \in \mathbb{Z} \}, \quad (5.2)$$

and the volume of the unit cell is $V = \mathbf{a}_1 \cdot (\mathbf{a}_2 \wedge \mathbf{a}_3)$ (we assume a right-handed basis set). Λ is made from packing together unit cells. Note in this example, that V is independent of the particular basis chosen. Defined in this way Λ is called a **Bravais lattice**; the Bravais lattice defines the **translation symmetry**.

The unit cell is not unique; indeed some may be larger in volume than others. Hence, the basis vectors chosen are not unique either. There is, however, a particular choice called the **primitive unit cell** which is the smallest unit of the lattice which, by translation, will tessellate the space. It is a unit cell of the smallest volume. The primitive cell is not unique either but all such cells have the same, and smallest, volume; in the example of the simple cubic lattice above both cells shown, with bases $(\mathbf{a}_1, \mathbf{a}_2)$ and $(\mathbf{a}'_1, \mathbf{a}_2)$, are candidates.

We can count the number of lattice sites per unit cell and for the primitive unit cell there is exactly one site per cell. In the face-centred cubic lattice the unit cell with basis $(\mathbf{a}_1, \mathbf{a}_2)$ has two sites per cell, each corner site contributes 1/4 plus 1 for the centre site. The primitive cell has basis $(\mathbf{a}'_1, \mathbf{a}'_2)$ and has one site per cell. When the basis for a primitive unit cell is used then the position, \mathbf{l} , of every lattice site can be written using integers only: $\mathbf{l} = l_i \mathbf{a}_i$, $l_i \in \mathbb{Z}$ $i = 1 \dots D$. This is useful.

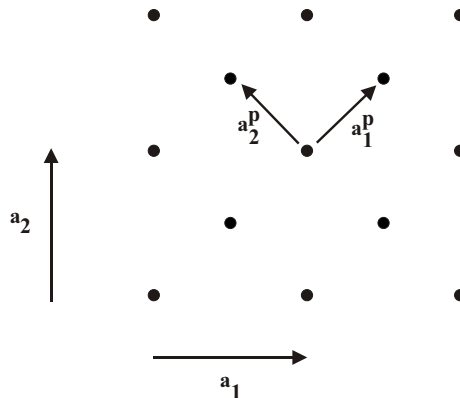

In two-dimensions there are 5 distinct Bravais lattices and in three-dimensions there are 14 distinct Bravais lattices. We shall come back to some 3D examples shortly.

Consider a general discrete set of lattice sites in \mathbb{R}^D . The **Voronoi** tessellation of \mathbb{R}^D is a set of cells filling the space where all the points in the interior of a given cell are closer to one particular lattice site than any other lattice site. We shall only be interested in sites in $D = 1, 2, 3$ which form a Bravais lattice but the idea is more general.

For a Bravais lattice the **Voronoi cells** about each point are identical; the Voronoi cells of lattices are also called **Wigner-Seitz cells**. For a lattice the **Voronoi** or **Wigner-Seitz** unit cell, Γ , consists of all those points in \mathbb{R}^D for which the origin $\mathbf{0}$ is the **nearest** point of Λ :

$$\Gamma = \{ \mathbf{x} : |\mathbf{x} - \mathbf{l}| > |\mathbf{x}|, \quad \mathbf{x} \in \mathbb{R}^3, \quad \mathbf{l} \in \Lambda, \quad \mathbf{l} \neq \mathbf{0} \}. \quad (5.3)$$

In $D = 3$ there are 5 distinct Voronoi cells. The restriction is that they are *parallelohedra* since they tessellate the whole space when placed face to face in parallel displacement. Examples in 2D for cubic and hexagonal lattices are shown below:

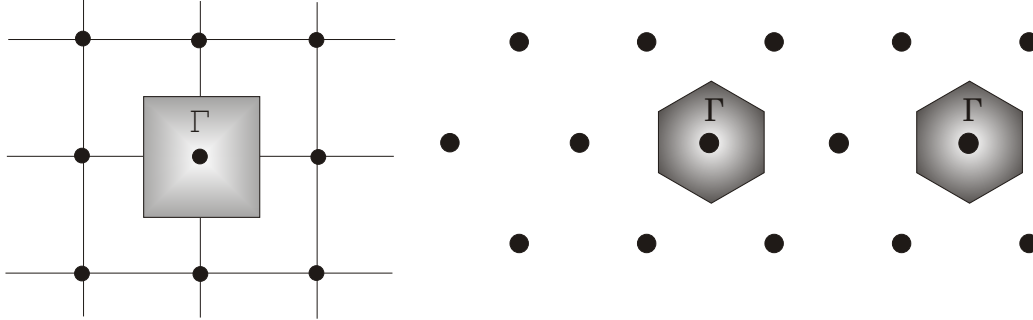

The Wigner-Seitz cell is a canonical choice for the primitive unit cell. The basis vectors are defined so that translations of Γ by $\mathbf{l} = l_i \mathbf{a}_i$, $l_i \in \mathbb{Z}$ $i = 1 \dots D$ tessellate the space \mathbb{R}^D .

5.1 Crystal Structure in 3D

There are 14 Bravais lattices in 3D and we shall not detail their properties here but briefly mention some examples. The Bravais lattice is a regular lattice of sites in \mathbb{R}^3 , but the physical unit that occupies each site in a crystal structure can be complex. For example, there may be one atom or molecule of given species at each site, or there may be two or more atoms forming the unit associated with each site.

A **crystal structure** is a Bravais lattice with a **basis** of the same physical unit, made of one or more atoms, at each lattice site. The crystal looks the same when viewed from each lattice site. The resulting lattice of atoms might not be a Bravais lattice but, for example, look like two or more interlaced Bravais lattices.

The lattices considered here are simple-cubic, face-centred cubic (FCC) and body-centred cubic (BCC). They are all based on a cubic structure and the latter two with decorations.

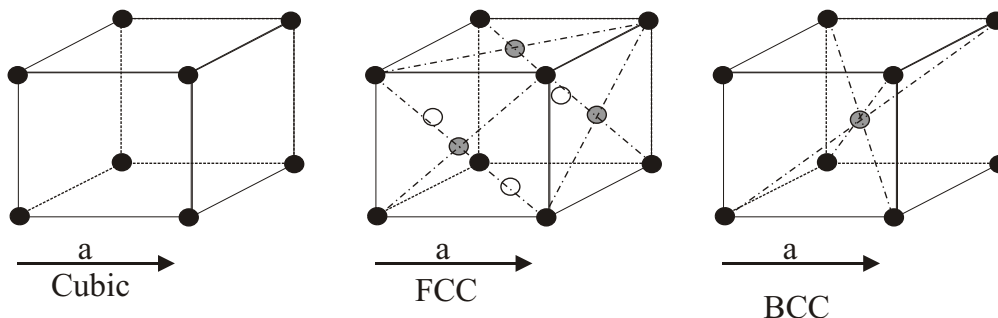

The difference in shading does not signify different atoms but is to help guide the eye.

(i) **Cubic.** The basis vectors of the primitive unit cell are

$$\mathbf{a}_1 = a\mathbf{i}, \mathbf{a}_2 = a\mathbf{j}, \mathbf{a}_3 = a\mathbf{k}, \quad V = a^3. \quad (5.1.1)$$

(ii) **FCC.** The basis vectors of the primitive unit cell are

$$\mathbf{a}_1 = \frac{a}{2}(\mathbf{j} + \mathbf{k}), \mathbf{a}_2 = \frac{a}{2}(\mathbf{i} + \mathbf{k}), \mathbf{a}_3 = \frac{a}{2}(\mathbf{i} + \mathbf{j}), \quad V = \frac{a^3}{4}. \quad (5.1.2)$$

(iii) **BCC.** The basis vectors of the primitive unit cell are

$$\mathbf{a}_1 = \frac{a}{2}(\mathbf{i} - \mathbf{j} + \mathbf{k}), \mathbf{a}_2 = \frac{a}{2}(\mathbf{i} + \mathbf{j} + \mathbf{k}), \mathbf{a}_3 = a\mathbf{k}, \quad V = \frac{a^3}{2}. \quad (5.1.3)$$

There is one site per unit cell as can be seen from the volume, V , of each cell. Of course, these choices are still not unique. We could use the Voronoi cells instead – a good choice, but they do not look simple. Here is a picture from Wannier of the Voronoi cell for a BCC lattice.

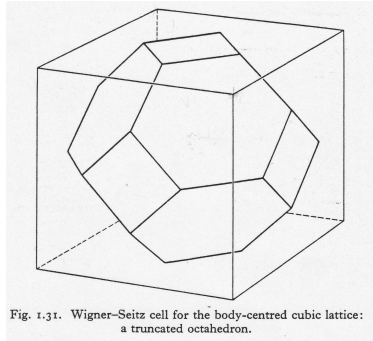

An example of a physical crystal is the diamond lattice which can be thought of as a FCC lattice with two carbon atoms at each site placed at

$$\mathbf{l} \text{ and } \mathbf{l} + \mathbf{d}, \text{ with } \mathbf{d} = \frac{a}{4}(\mathbf{i} + \mathbf{j} + \mathbf{k}), \quad \mathbf{l} = l_i \mathbf{a}_i. \quad (5.1.4)$$

The physical unit is a pair of atoms with displacement vector \mathbf{d} . Alternatively, it looks like two identical interlaced FCC lattices each with one carbon atom per site and displaced by the vector \mathbf{d} with respect to each other. This is also the structure of silicon and gallium-arsenide which are two important semi-conductor materials.

Salt, $NaCl$, is another example. This is a FCC lattice with the unit $Na - Cl$ at each site. Again it looks like two interlaced FCC lattices: one for the Na atoms and one for the Cl atoms.

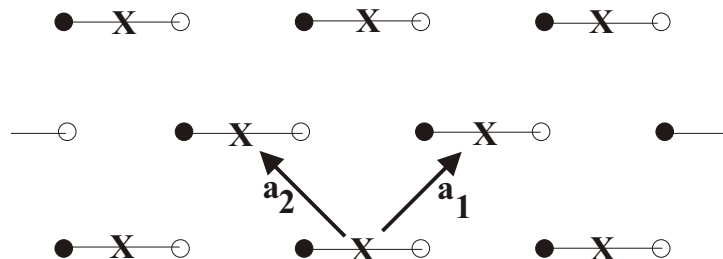

The crosses are the sites of the FCC Bravais lattice with primitive basis vectors $(\mathbf{a}_1, \mathbf{a}_2)$.

5.2 Discrete Translation Invariance

Consider the motion of an electron in a periodic potential; this is a model for the effect of the crystal lattice on the individual electron. Because the potential is periodic we have

$$V(\mathbf{r}) = V(\mathbf{r} + \mathbf{l}) \quad \mathbf{l} \in \Lambda . \quad (5.2.1)$$

Hence, if $V(\mathbf{r})$ is known in the unit cell it is known everywhere. The Hamiltonian is, as usual,

$$H = -\frac{\hbar^2}{2m}\nabla^2 + V(\mathbf{r}) , \quad (5.2.2)$$

and let $\psi(\mathbf{r})$ be an eigenfunction of H : $H\psi(\mathbf{r}) = E\psi(\mathbf{r})$. It follows from periodicity that $\psi_{\mathbf{l}}(\mathbf{r}) = \psi(\mathbf{r} + \mathbf{l})$, $\mathbf{l} \in \Lambda$, is **also** an eigenfunction with the same energy, E . Thus the map $T_{\mathbf{l}}$, where

$$\psi(\mathbf{r}) \xrightarrow{T_{\mathbf{l}}} \psi_{\mathbf{l}}(\mathbf{r}) = T_{\mathbf{l}}\psi(\mathbf{r}) = \psi(\mathbf{r} + \mathbf{l}) \quad (5.2.3)$$

maps the eigenspace of H onto itself. Since $T_{\mathbf{l}}$ leaves the **normalization** and **orthogonality** of the wavefunctions unchanged then it is a **unitary** map:

$$\begin{aligned} \int \psi^*(\mathbf{r})T_{\mathbf{l}}\psi(\mathbf{r})d^3x &= \int \psi^*(\mathbf{r})\psi(\mathbf{r} + \mathbf{l})d^3x \\ &= \int \psi(\mathbf{r} - \mathbf{l})\psi(\mathbf{r})d^3x \quad (\text{by shift of origin}) \\ &= \int [T_{-\mathbf{l}}\psi(\mathbf{r})]^* \psi(\mathbf{r})d^3x \quad \implies \\ T_{\mathbf{l}}^\dagger &= T_{-\mathbf{l}} . \end{aligned} \quad (5.2.4)$$

But

$$T_{\mathbf{l}}^{-1} = T_{-\mathbf{l}} \implies T_{\mathbf{l}}^\dagger = T_{\mathbf{l}}^{-1} . \quad (5.2.5)$$

I.e., $T_{\mathbf{l}}$ is **unitary**. Also, if $\mathbf{l}, \mathbf{l}' \in \Lambda$ then

$$T_{\mathbf{l}}T_{\mathbf{l}'} = T_{\mathbf{l}+\mathbf{l}'} = T_{\mathbf{l}'}T_{\mathbf{l}} , \quad (5.2.6)$$

and hence,

$$T_{\mathbf{l}} = T_{l_1\mathbf{a}_1+l_2\mathbf{a}_2+l_3\mathbf{a}_3} = (T_{\mathbf{a}_1})^{l_1} \cdot (T_{\mathbf{a}_2})^{l_2} \cdot (T_{\mathbf{a}_3})^{l_3} . \quad (5.2.7)$$

Translations form an abelian group with generators $T_{\mathbf{a}_i}$, $i = 1, 2, 3$. Since $T_{\mathbf{a}_i}$ is unitary there exists an Hermitian operator P_i such that

$$T_{\mathbf{a}_i} = e^{iP_i} . \quad (5.2.8)$$

Now have

$$T_{\mathbf{l}}H\psi(\mathbf{r}) = E\psi(\mathbf{r} + \mathbf{l}) , \quad (5.2.9)$$

and also

$$HT_{\mathbf{l}}\psi(\mathbf{r}) = H\psi(\mathbf{r} + \mathbf{l}) = E\psi(\mathbf{r} + \mathbf{l}) , \quad (5.2.10)$$

since $\psi(\mathbf{r} + \mathbf{l})$ is an eigenstate of H with energy E because of periodicity. Thus

$$[H, T_{\mathbf{l}}] = 0 , \quad \forall \mathbf{l} \in \Lambda \quad \implies \quad [H, P_i] = 0 , \quad i = 1, 2, 3 . \quad (5.2.11)$$

From eqn. (5.2.6) we infer that also $[P_i, P_j] = 0$, $i, j = 1, 2, 3$. Thus, the P_i are **conserved** operators, i.e. they correspond to **constants** of the motion, and from above we have that

$$T_{\mathbf{l}} = e^{i(l_1 P_1 + l_2 P_2 + l_3 P_3)} \equiv e^{i\mathbf{l} \cdot \mathbf{P}}. \quad (5.2.12)$$

The **eigenvalues** of the P_i can be used to **classify** the eigenstates of H as follows. Let

$$H\psi = E\psi \quad \text{and} \quad P_i\psi = k_i\psi. \quad (5.2.13)$$

Then the quantum numbers (E, \mathbf{k}) classify the states and form part of the complete set. We have

$$T_{\mathbf{l}}\psi(\mathbf{r}) = \psi(\mathbf{r} + \mathbf{l}) = e^{i\mathbf{l} \cdot \mathbf{P}}\psi(\mathbf{r}) = e^{i\mathbf{l} \cdot \mathbf{k}}\psi(\mathbf{r}), \quad (5.2.14)$$

with $\mathbf{k} = (k_1, k_2, k_3)$.

5.3 Periodic Functions

It is straightforward to construct functions which are periodic on a lattice. By periodic we mean that $F(\mathbf{r})$ is periodic if

$$F(\mathbf{r} + \mathbf{l}) = F(\mathbf{r}) \quad \forall \quad \mathbf{l} \in \Lambda. \quad (5.3.1)$$

A periodic function can be constructed from a general function $\phi(\mathbf{r})$, not necessarily periodic, as follows:

$$F(\mathbf{r}) = \sum_{\mathbf{l} \in \Lambda} \phi(\mathbf{r} - \mathbf{l}) = \sum_{\mathbf{l} \in \Lambda} \phi_{\mathbf{l}}(\mathbf{r}), \quad (5.3.2)$$

where we have introduced the notation $\phi_{\mathbf{l}}(\mathbf{r}) = \phi(\mathbf{r} - \mathbf{l})$.

5.4 Reciprocal Vectors and Reciprocal Lattice

The vectors \mathbf{b}_i **reciprocal** to the basis vectors \mathbf{a}_i are defined by

$$\begin{aligned} \mathbf{b}_1 &= \frac{2\pi}{V}(\mathbf{a}_2 \wedge \mathbf{a}_3) \quad \text{etc}, \quad V = \mathbf{a}_1 \cdot (\mathbf{a}_2 \wedge \mathbf{a}_3), \\ \text{i.e., } \mathbf{b}_i &= \frac{1}{2} \varepsilon_{ijk} \mathbf{a}_j \wedge \mathbf{a}_k. \end{aligned} \quad (5.4.1)$$

V is the volume of the unit cell of Λ . Although not at all necessary, it is useful to use the basis for the primitive unit cell in what follows. Then

$$\mathbf{b}_i \cdot \mathbf{a}_j = 2\pi \delta_{ij}. \quad (5.4.2)$$

The basis set $\{\mathbf{b}\}$ is **dual** to the basis set $\{\mathbf{a}\}$ and allows a simple construction for the inner product even when the basis vectors are not orthonormal although they are, of course, independent. We also have

$$\begin{aligned} \mathbf{a}_i &= \frac{V}{(2\pi)^2} \frac{1}{2} \varepsilon_{ijk} \mathbf{b}_j \wedge \mathbf{b}_k = \frac{2\pi}{V^*} \frac{1}{2} \varepsilon_{ijk} \mathbf{b}_j \wedge \mathbf{b}_k, \\ \text{with } V^* &= \mathbf{b}_1 \cdot (\mathbf{b}_2 \wedge \mathbf{b}_3) = \frac{(2\pi)^3}{V}. \end{aligned} \quad (5.4.3)$$

The **reciprocal lattice** is the set of points

$$\Lambda^* = n_1 \mathbf{b}_1 + n_2 \mathbf{b}_2 + n_3 \mathbf{b}_3 : n_i \in \mathbb{Z} , \quad (5.4.4)$$

and V^* is the volume of the unit cell of Λ^* .

It is interesting to note that if Λ is FCC than Λ^* is BCC and vice-versa.

The construction is useful because it enables the Fourier representation of wavefunctions in a periodic lattice to be clearly and easily formulated. Suppose

$$\begin{aligned} \mathbf{x} &= x_i \mathbf{a}_i & \text{and} & & \mathbf{q} &= q_i \mathbf{b}_i , \\ \text{then } \mathbf{x} \cdot \mathbf{q} &= 2\pi x_i q_i . \end{aligned} \quad (5.4.5)$$

In particular if $\mathbf{x} \in \Lambda$ and $\mathbf{q} \in \Lambda^*$ then

$$\mathbf{x} \cdot \mathbf{q} = 2\pi m , \quad m \in \mathbb{Z} . \quad (5.4.6)$$

As an example, consider the sum over Λ :

$$\Delta(\mathbf{Q}) = \sum_{\mathbf{a} \in \Lambda} e^{i\mathbf{Q} \cdot \mathbf{a}} . \quad (5.4.7)$$

We can always write $\mathbf{Q} = q_i \mathbf{b}_i$ and with $\mathbf{a} = l_i \mathbf{a}_i$, $l_i \in \mathbb{Z}$, we get

$$\Delta(\mathbf{Q}) = \sum_{l_1} e^{2\pi i q_1 l_1} \sum_{l_2} e^{2\pi i q_2 l_2} \sum_{l_3} e^{2\pi i q_3 l_3} . \quad (5.4.8)$$

Define

$$\sigma(q) = \sum_{l=-N/2+1}^{N/2} e^{2\pi i q l} = \frac{\sin N\pi q}{\sin \pi q} . \quad (5.4.9)$$

$$\begin{aligned} \sigma(n) &= N , \\ \text{width of peak} &\sim N^{-1} \end{aligned}$$

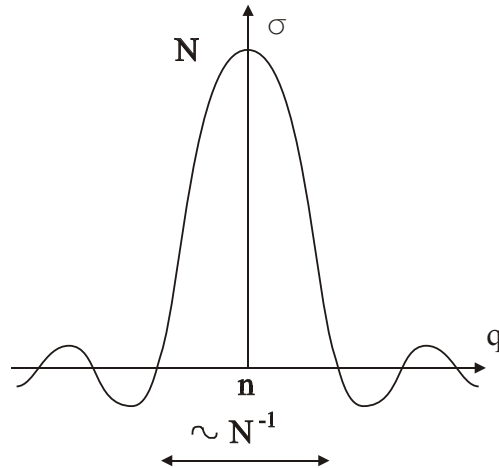

But $\Delta(\mathbf{Q}) = \sigma(q_1)\sigma(q_2)\sigma(q_3)$ and hence $\Delta(\mathbf{Q})$ is sharply peaked for $q_i = n_i$, $n_i \in \mathbb{Z}$; i.e., for $\mathbf{Q} \in \Lambda^*$, the **reciprocal lattice**.

As $N \rightarrow \infty$ the area under the curve of $\sigma(q)$ for $-\varepsilon < q < \varepsilon$, $\varepsilon \gg 1/N$ tends to 1.

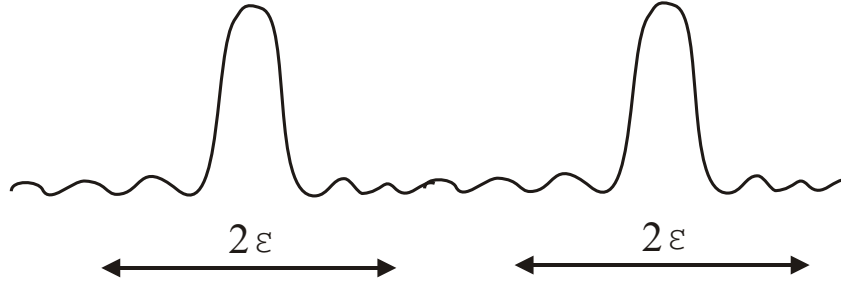

To see this write $\sin \pi q \sim \pi q$ in the denominator and use $\frac{1}{\pi} \int_{-\infty}^{\infty} \frac{\sin x}{x} dx = 1$. Thus, in the limit $N \rightarrow \infty$, $\varepsilon \rightarrow 0$, $\varepsilon N \gg 1$ we have

$$\begin{aligned} \sigma(q) &= \sum_{n \in \mathbb{Z}} \delta(q - n) \implies \\ \Delta(\mathbf{Q}) &= \sum_{n_1 \in \mathbb{Z}} \delta(q_1 - n_1) \sum_{n_2 \in \mathbb{Z}} \delta(q_2 - n_2) \sum_{n_3 \in \mathbb{Z}} \delta(q_3 - n_3), \\ \text{or } \Delta(\mathbf{Q}) &= V^* \sum_{\mathbf{b} \in \Lambda^*} \delta(\mathbf{Q} - \mathbf{b}). \end{aligned} \quad (5.4.10)$$

$V^*(V)$ is volume of unit cell of $\Lambda^*(\Lambda)$, and $VV^* = (2\pi)^3$.

5.5 Bragg Scattering on a rigid Lattice

Scatter beam of particles (typically electrons, neutrons or X-ray photons) on a crystal consisting of atoms sites at points of a lattice Λ .

The wavefunction of the incident plane wave is $e^{i\mathbf{k} \cdot \mathbf{r}}$. For scattering off an atom at $\mathbf{r} = \mathbf{0}$ the scattering wavefunction has the asymptotic form

$$\psi_{\mathbf{0}}(\mathbf{r}) \sim e^{i\mathbf{k} \cdot \mathbf{r}} + f(\hat{\mathbf{r}}) \frac{e^{ikr}}{r}, \quad r \rightarrow \infty. \quad (5.5.1)$$

For scattering of the **same** plane wave off an atom situated at $\mathbf{r} = \mathbf{a}$ we refer to an origin at $\mathbf{r} = \mathbf{a}$ to implement the usual scattering boundary condition. We write the unscattered plane wave as

$$e^{i\mathbf{k} \cdot \mathbf{r}} = e^{i\mathbf{k} \cdot \mathbf{a}} e^{i\mathbf{k} \cdot \mathbf{r}'}, \quad \mathbf{r}' = \mathbf{r} - \mathbf{a}. \quad (5.5.2)$$

So it looks like a plane wave w.r.t. the new origin but shifted by a familiar translation phase factor $e^{i\mathbf{k} \cdot \mathbf{a}}$. Then as $r \rightarrow \infty$ the scattering wavefunction from the site at $\mathbf{r} = \mathbf{a}$ is

$$\psi_{\mathbf{a}}(\mathbf{r}) = e^{i\mathbf{k} \cdot \mathbf{a}} \underbrace{\left(e^{i\mathbf{k} \cdot \mathbf{r}'} + f(\hat{\mathbf{r}}') \frac{e^{ikr'}}{r'} \right)}_{\substack{\text{correct asymptotic form} \\ \text{w.r.t. origin at } \mathbf{r} = \mathbf{a}}}. \quad (5.5.3)$$

- (i) The scattered wave takes the **standard** form **relative** to an origin at $\mathbf{r} = \mathbf{a}$ and the initial phase factor translates the wavefunction to coordinates with origin at $\mathbf{0}$.
- (ii) The **incident** wave is the **same**, independent of the position of the scattering centre.

We thus have

$$\psi_{\mathbf{a}}(\mathbf{r}) \sim e^{i\mathbf{k} \cdot \mathbf{r}} + f(\hat{\mathbf{r}}') \frac{e^{ikr'}}{r'}, \quad \mathbf{r}' = \mathbf{r} - \mathbf{a}, \quad r \rightarrow \infty. \quad (5.5.4)$$

Now, as $r \rightarrow \infty$

$$r' = |\mathbf{r} - \mathbf{a}| \sim r - \hat{\mathbf{r}} \cdot \mathbf{a}, \quad \hat{\mathbf{r}}' \sim \hat{\mathbf{r}}. \quad (5.5.5)$$

Thus the outgoing scattered wave is asymptotically

$$\psi_{\text{scatt}}(\mathbf{r}) \sim \frac{f(\hat{\mathbf{r}})}{r} e^{i\mathbf{k} \cdot \mathbf{a}} e^{ik(r - \hat{\mathbf{r}} \cdot \mathbf{a})}. \quad (5.5.6)$$

We define $\mathbf{k}' = k\hat{\mathbf{r}}$ since the outgoing particle has wavevector of magnitude k and is in the direction $\hat{\mathbf{r}}$. Then we finally get

$$\psi_{\mathbf{a}}(\mathbf{r}) \sim e^{i\mathbf{k} \cdot \mathbf{r}} + e^{i(\mathbf{k} - \mathbf{k}') \cdot \mathbf{a}} \frac{e^{ikr}}{r} f(\hat{\mathbf{r}}'). \quad (5.5.7)$$

The **total** amplitude for scattering is the **sum** over the lattice of the individual amplitudes (ignoring multiple scattering). Thus,

$$f_{\Lambda}(\hat{\mathbf{r}}) = \sum_{\mathbf{a} \in \Lambda} e^{i\mathbf{Q} \cdot \mathbf{a}} f(\hat{\mathbf{r}}), \quad \mathbf{Q} = \mathbf{k} - \mathbf{k}', \quad (5.5.8)$$

or

$$f_{\Lambda}(\hat{\mathbf{r}}) = \Delta(\mathbf{Q}) f(\hat{\mathbf{r}}). \quad (5.5.9)$$

$\Delta(\mathbf{Q})$ is **very small** unless $\mathbf{Q} \in \Lambda^*$ when it is sharply peaked. Although in the approximation of an infinite exact lattice we have that $\Delta(\mathbf{Q}) = \sum_{\mathbf{a} \in \Lambda^*} \delta(\mathbf{Q} - \mathbf{a})$, because of atomic vibrations etc., $\Delta(\mathbf{Q})$ is smeared out and is **strongly peaked** function for $\mathbf{Q} \in \Lambda^*$.

We deduce from this result the **Bragg condition** which states that scattering occurs only when the momentum transfer, $\hbar\mathbf{Q}$ satisfies

$$\hbar\mathbf{Q} \equiv \hbar(\mathbf{k} - \mathbf{k}') = \hbar\mathbf{b} \quad \mathbf{b} \in \Lambda^*. \quad (5.5.10)$$

For the beam $k = \sqrt{2mE/\hbar^2}$, $|\mathbf{k}'| = k$. The Bragg condition then becomes

$$\mathbf{k} - \mathbf{k}' = \mathbf{b} \implies 2k^2(1 - \cos\theta) = |\mathbf{b}|^2 \implies 2k \sin(\theta/2) = |\mathbf{b}|, \quad k = \frac{2\pi}{\lambda}. \quad (5.5.11)$$

Only get scattering at angles θ satisfying this condition. The interpretation is that each $\mathbf{b}' \in \Lambda^*$ defines a set of parallel planes in Λ : $\mathbf{a} \cdot \mathbf{b}' = 2\pi n$, $\mathbf{a} \in \Lambda$, $n \in \mathbb{Z}$. Each plane, labelled by n , consists of atoms at the sites \mathbf{a} . The separation between **successive** planes is clearly $d = 2\pi/|\mathbf{b}'|$.

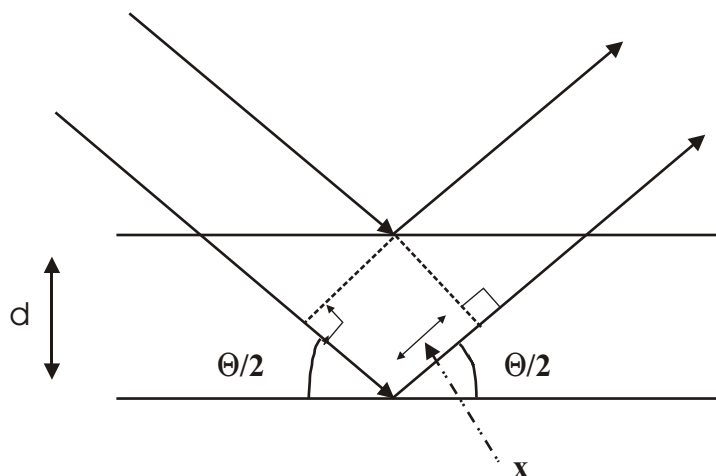

The path difference between beams reflected off successive planes is $2x = 2d \sin(\theta/2)$. **Constructive** interference at the detector implies that

$$2d \sin(\theta/2) = n\lambda \quad \implies \quad 2k \sin(\theta/2) = n|\mathbf{b}'| \equiv |\mathbf{b}|. \quad (5.5.12)$$

Note that $\mathbf{b} = n\mathbf{b}' \in \Lambda^*$ if $\mathbf{b}' \in \Lambda^*$.

The formula for the differential scattering cross-section from a rigid lattice is then

$$\frac{d\sigma}{d\Omega} = \Delta^2(\mathbf{Q}) |f_\Lambda(\mathbf{k}, \mathbf{k}')|^2, \quad (5.5.13)$$

where I have written $f_\Lambda(\hat{\mathbf{r}}) = f_\Lambda(\mathbf{k}, \mathbf{k}')$ since for an incoming wave with wavevector \mathbf{k} then $\hat{\mathbf{r}} = \mathbf{k}'/|\mathbf{k}|$ defines scattering direction. This follows the notation from Green function scattering theory. Consider a large but **finite** lattice consisting of N sites (N large). It is convenient to think of the lattice as having periodic boundary conditions but this is not a necessity. Then we have

$$\begin{aligned} \Delta^2(\mathbf{Q}) &= \sum_{\mathbf{a}, \mathbf{a}' \in \Lambda} e^{i\mathbf{Q} \cdot (\mathbf{a} - \mathbf{a}')} \\ &= N \sum_{\mathbf{a} \in \Lambda} e^{i\mathbf{Q} \cdot \mathbf{a}} = N\Delta(\mathbf{Q}), \end{aligned} \quad (5.5.14)$$

where the minus sign on \mathbf{a}' in the exponent just means that in the sum over $\mathbf{a}' \in \Lambda$ the lattice sites are counted in the opposite order from that for the sum over \mathbf{a} ; nevertheless, all terms in the summation are present but have been labelled more usefully. The result follows by translation symmetry where the site at \mathbf{a}' is considered as the origin; the lattice description is independent of choice of origin. Of course, for a small lattice there would be end effects which are, in practice, negligible. Thus have

$$\frac{d\sigma}{d\Omega} = N\Delta(\mathbf{Q}) |f_\Lambda(\mathbf{k}, \mathbf{k}')|^2. \quad (5.5.15)$$

A practical example of a Bragg scattering experiment is where a powder is made of small crystals in which the crystals are randomly oriented. For a given incident

direction there are always many crystals in exactly the correct orientation for each set of planes to satisfy the Bragg condition. Thus, electrons (or photons as X-rays) scatter strongly and show all possible scattering angles compatible with the Bragg condition. This figure is courtesy of the Materials Science Department in Cambridge:

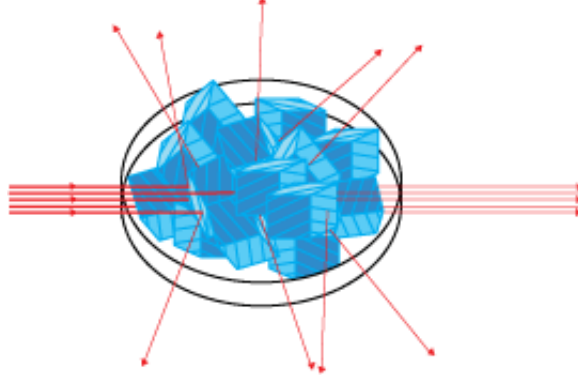

Of course, the scattered beams will lie on cones determined by the Bragg angle, and the intensity will depend on $|f_{\Lambda}(\mathbf{k}, \mathbf{k}')|^2$. Typically, the scattering will be stronger for small n since the scattering angle is smaller for a given set of planes. Indeed, since $|f(\mathbf{k}, \mathbf{k}')|^2$ will typically decrease as $|\mathbf{k} - \mathbf{k}'|$ increases, we expect that the intensity of scattering will decrease as the scattering angle, θ , increases.

In the **Born approximation**

$$f(\mathbf{Q}) \equiv f(\mathbf{k}, \mathbf{k}') = -\frac{m}{2\pi\hbar^2} \langle \mathbf{k}' | V | \mathbf{k} \rangle = -\frac{m}{2\pi\hbar^2} \tilde{V}(\mathbf{Q}). \quad (5.5.16)$$

The scattering amplitude from the atom at site \mathbf{a} with potential $V_{\mathbf{a}}(\mathbf{r}) = V(\mathbf{r} - \mathbf{a})$ is then

$$f_{\mathbf{a}}(\mathbf{Q}) = -\frac{m}{2\pi\hbar^2} \langle \mathbf{k}' | V_{\mathbf{a}} | \mathbf{k} \rangle = -\frac{m}{2\pi\hbar^2} \int d^3r e^{-i\mathbf{k}' \cdot \mathbf{r}} V(\mathbf{r} - \mathbf{a}) e^{i\mathbf{k} \cdot \mathbf{r}}. \quad (5.5.17)$$

Changing variable to $\mathbf{r} - \mathbf{a}$ get

$$f_{\mathbf{a}}(\mathbf{Q}) = -\frac{m}{2\pi\hbar^2} e^{i\mathbf{Q} \cdot \mathbf{a}} \int d^3r e^{i\mathbf{Q} \cdot \mathbf{r}} V(\mathbf{r}) = e^{i\mathbf{Q} \cdot \mathbf{a}} f(\mathbf{Q}). \quad (5.5.18)$$

The total scattering amplitude from the crystal is the sum of the individual amplitudes from each scattering site:

$$f_{\Lambda}(\mathbf{Q}) = \sum_{\mathbf{a} \in \Lambda} f_{\mathbf{a}}(\mathbf{Q}) = \Delta(\mathbf{Q}) f(\mathbf{Q}), \quad (5.5.19)$$

as derived generally earlier.

6 Particle in a One-Dimensional Periodic Potential

We apply the ideas and definitions of the previous section to the properties and dynamics of a particle moving in a 1D periodic potential. An important example is that

of an electron moving in a 1D crystal lattice consisting of an atom at each lattice site. The potential due to the atoms is then periodic and we must solve the associated Schrödinger equation for the system dynamics.

There is only one Bravais lattice in 1D

$$\Lambda = \{x = na : n \in \mathbb{Z}\}, \quad (6.1)$$

and it looks like



with lattice spacing a which is also the basis vector for the unit cell. The translation group is simple;

$$T_l \psi(x) = \psi(x + l) \quad l = na, \quad n \in \mathbb{Z}. \quad (6.2)$$

For a **periodic** function, $V(x)$, have $T_l V(x) = V(x + l) = V(x)$.

Let $\psi(k, x)$ be an eigenfunction of the generator of translations, P , with $P \psi(k, x) = k \psi(k, x)$. Then

$$T_l \psi(k, x) = e^{ikl} \psi(k, x). \quad (6.3)$$

A general periodic function in 1D can be constructed as

$$F(x) = \sum_{n=-\infty}^{\infty} \phi(x - na). \quad (6.4)$$

The reciprocal lattice is straightforward

$$\Lambda^* = \{x = nb : b = 2\pi/a, \quad n \in \mathbb{Z}\}, \quad (6.5)$$

with basis vector of length $b = 2\pi/a$, so that b satisfies the 1D version of eqn. (5.4.2), namely $ba = 2\pi$.

In what follows we shall always consider the lattice to have N sites but consider the limit $N \rightarrow \infty$ with appropriate boundary conditions. For example, periodic boundary conditions would modify the definitions so that integers are restricted to $n \in \mathbb{Z}_N$.

6.1 Band Structure

If an atom is isolated then the electrons are bound to the nucleus and are localized to its neighbourhood. If a number of atoms are brought close enough together the quantum-mechanical state of the system becomes complicated very quickly, but one thing is clear that an electron formerly bound to one nucleus can migrate by tunnelling throughout the system. If the atoms are arranged at the sites of a regular lattice then the electrons formerly associated with particular atoms can tunnel arbitrarily far in the lattice to other atomic sites; they are no longer bound but become delocalized and can propagate through the lattice. The energy levels of the electrons lie in allowed

bands much like the allowed states that they can occupy in an atom; indeed, we shall see that in the case of the tight-binding model the two systems are closely related.

Band structure for electrons in crystals is the basis for the rich electrical phenomena of regular solids; for example, they may be conductors, semi-conductors or insulators. To illustrate the important phenomenon of band structure we consider some model systems.

6.1.1 The Tight Binding Model

In this model we assume that the electron is tightly bound to its associated atom when in isolation and that the proximity of atoms on neighbouring sites does not distort the atomic potential very strongly. However, the potential experienced by an electron is now periodic albeit strongly attractive near to each site.

Consider a 1D array of N atoms and concentrate on the **same** atomic level in each atom. Consider an electron in that level for a given atom. Although this electron may initially be thought of as bound to the site, there is a probability that given enough time it will be found near a far-away site. What happens is that the electron tunnels through the barrier between the atoms and can thus migrate arbitrarily far from the original site. A simple picture is one where tunnelling to nearest-neighbour sites dominates all other processes:

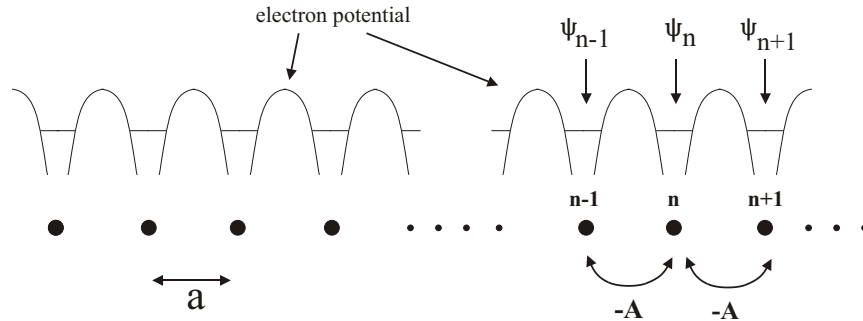

The lattice spacing is a . The electron on the n -th atom is represented by the state ψ_n . The Hamiltonian is $H = H_0 + V$ where

$$\begin{aligned} H_0\psi_n &= E_0\psi_n, \\ (\psi_n, V\psi_n) &= \alpha, & (\psi_n, V\psi_{n\pm 1}) &= -A, \\ (\psi_n, V\psi_m) &= 0, & m &\neq n, n \pm 1. \end{aligned} \quad (6.1.1.1)$$

So H_0 is the Hamiltonian for an atom in isolation and ψ_n is the wavefunction for the **chosen** level on the n -th atom. The potential $V(x)$ is due to the proximity of atoms on all other sites. Note that

$$\psi_n(x) = \psi_0(x - na), \quad (6.1.1.2)$$

i.e., all wavefunctions are related by translation of the origin – it is the **same** level in each atom. We will also make the approximation that $(\psi_n, \psi_m) = \delta_{mn}$. From eqn. (6.1.1.2) this is not strictly true but is correct up to exponentially small corrections.

The potential V is due solely to the presence of the neighbouring atoms and the matrix element $-A$ is the **tunnelling amplitude** between neighbouring sites. We want to solve the full problem:

$$H\Psi = E\Psi , \quad (6.1.1.3)$$

and we use a variational ansatz and write

$$\Psi = \sum_p c_p \psi_p . \quad (6.1.1.4)$$

This is not the same as expanding on a complete basis since we have ignored other atomic wavefunctions of the atom with energies different from E_0 ; these would need to be included in a full basis expansion. Then using (6.1.1.3)

$$H \sum_p c_p \psi_p = (H_0 + V) \sum_p c_p \psi_p = E \sum_p c_p \psi_p . \quad (6.1.1.5)$$

Take the inner product of both sides with ψ_n and use eqns. (6.1.1.1):

$$\begin{aligned} \sum_p c_p (\psi_n, (H_0 + V) \psi_p) &= E c_n \\ \underbrace{(E_0 + \alpha)}_{E'_0} c_n - A(c_{n-1} + c_{n+1}) &= E c_n . \end{aligned} \quad (6.1.1.6)$$

[This kind of equation occurs in the classical dynamics of a set of equally spaced particles in 1D interconnected by springs. The solution to that problem is that waves can travel freely up and down the chain. As a classical model of a 1D crystal such waves are simply sound waves. We shall consider such systems later when discussing lattice vibrations and phonons.]

We need to solve this difference equation for the $\{c_n\}$ and so try the substitution:

$$\begin{aligned} c_n &= e^{ikna} , & \text{normal mode solution} \\ \Rightarrow c_{n\pm 1} &= e^{\pm ika} c_n , \end{aligned} \quad (6.1.1.7)$$

where we remember that a is the spacing and that the n -th atom is situated at $x_n = na$. Substituting in eqn. (6.1.1.6) we get

$$\boxed{E \equiv E(k) = E'_0 - 2A \cos ka .} \quad (6.1.1.8)$$

The N atomic levels which were originally **degenerate** at E_0 are replaced by N new levels which are spread out in energy according to eqn. (6.1.1.8). The old state labelling, n , was by atomic position. The new labelling is by the **wavevector**, k , which contains no reference to position at all: for **each** value of k there is an eigenstate with energy $E(k)$.

To get the counting of states right we must think about boundary conditions at the ends of the chain of atoms. We impose periodicity and so we must have

$$c_N = c_0 \implies e^{ikNa} = 1 . \quad (6.1.1.9)$$

What happens at the ends cannot affect the bulk properties (c.f., the boundary conditions in a box that we used). Define $L = Na$, the chain length. Taking N even, this implies that

$$k = 2\pi m/L, \quad m \text{ an integer : } -\frac{N}{2} < m \leq \frac{N}{2}. \quad (6.1.1.10)$$

So k is discrete, taking one of N values which is consistent with starting with having N states in the first place. It is important to recognize that we may write k expanded on the basis vector of the reciprocal lattice $b = 2\pi/a$

$$k = \frac{m}{N} b \quad m \text{ an integer : } -\frac{N}{2} < m \leq \frac{N}{2}. \quad (6.1.1.11)$$

The important features so far are

- (i) the eigenstates are no longer degenerate in energy but are labelled by a wavevector k and have energy $E(k)$ which lies in a **band** of allowed energies determined by eqn. (6.1.1.8) called the dispersion relation. The band has width $4A$. This structure will occur for **each** atomic level. For the lower, more tightly bound, levels A is **small** and the bands are **narrow**. The higher bands are **wider** and may even overlap in energy;
- (ii) the electron is no longer **localized** on a given site but has a non-zero probability of being found anywhere, i.e., they are **extended**:

$$P_k(x) \propto |\Psi_k(x)|^2 = \left| \sum_n e^{ikna} \psi_n(x) \right|^2 \neq 0 \quad \forall x.$$

Schematically, the physical outcome of what we have solved is shown in the figure.

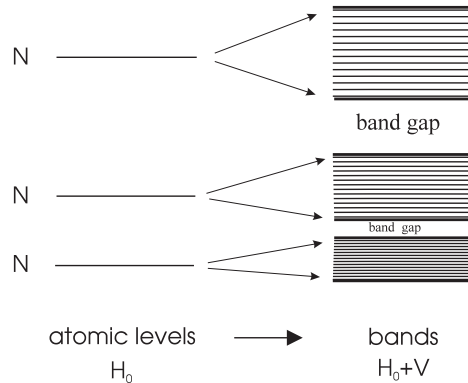

6.1.2 Bloch's Theorem and Bloch Waves in 1D

The stationary state is thus

$$\Psi_k(x) = C \sum_n e^{ikna} \psi_n(x). \quad (6.2.1.1)$$

Using eqn. (6.1.1.2), consider $x \rightarrow x + a$:

$$\begin{aligned} \Psi_k(x+a) &= C \sum_n e^{ikna} \psi_n(x+a) = C \sum_n e^{ikna} \psi_{n-1}(x), \\ &= e^{ika} \Psi_k(x). \end{aligned} \quad (6.2.1.2)$$

Notice we have labelled the state by k , the wave vector. Thus we can always write

$$\Psi_k(x) = u_k(x) e^{ikx}, \quad (6.2.1.3)$$

where the function $u_k(x)$ is **defined** by this relation and satisfies

$$u_k(x+a) = u_k(x). \quad (6.2.1.4)$$

I.e., $u_k(x)$ is **periodic** on the lattice. That $\Psi_k(x)$ can always be written in the form in eqn. (6.2.1.3) where $u_k(x)$ is a periodic function is the statement in 1D of **Bloch's theorem**. The explicit expression for $u_k(x)$ can be deduced from eqn. (6.2.1.1) and we find

$$u_k(x) = \sum_n e^{-ik(x-na)} \psi(x-na), \quad (6.2.1.5)$$

which is clearly a periodic function of the form given in eqn. (5.3.2) specialized to 1D. It is, however, also the **form** of the solution that should be emphasized. Displaying the time-dependence explicitly, the stationary state is

$\Psi_k(x, t) = u_k(x) e^{i(kx - \omega t)}$	Bloch Wave Solution.	(6.2.1.6)
--	-----------------------------	-----------

I have defined $\omega = E(k)/\hbar$.

Bloch's theorem can be generalized to the 3D case and we shall look at the general derivation later.

This solution represents the basic form of the stationary state for all problems involving periodic potentials and especially crystal lattices. It shows that the energy eigenstates are **travelling waves** which are **extended**. In particular, the electron can now carry charge from one end to the other in the form of an electric current.

6.1.3 The Floquet Matrix

There is another way to think of the wavefunction in periodic potential in 1D.

Suppose $\psi_1(x)$ and $\psi_2(x)$ are two real independent solutions of the Schrödinger equation with energy eigenvalue E . Since a second-order ODE has only two independent solutions then all solutions are expressible as a linear combination of the independent ones. For a periodic potential $\psi_1(x+a)$ and $\psi_2(x+a)$ are also solutions and so must have

$$\begin{pmatrix} \psi_1(x+a) \\ \psi_2(x+a) \end{pmatrix} = \underbrace{\begin{pmatrix} c_{11} & c_{12} \\ c_{21} & c_{22} \end{pmatrix}}_{\mathbf{C}} \begin{pmatrix} \psi_1(x) \\ \psi_2(x) \end{pmatrix}, \quad (6.3.1.1)$$

where the matrix \mathbf{C} is a function of E . Since the Wronskian is $W(\psi_1, \psi_2) = 1$ we find that $|\mathbf{C}(E)| = 1$.

Our 1D example of Bloch's theorem suggests that we look for solutions with the property that

$$\psi_1(x+a) = \lambda_1 \psi_1(x), \quad \psi_2(x+a) = \lambda_2 \psi_2(x), \quad (6.3.1.2)$$

for some λ_1, λ_2 which are clearly the eigenvalues of the translation operator T_a . We have argued that we should be able to classify the states by such quantum numbers. It

follows that λ_1, λ_2 are the eigenvalues of \mathbf{C} , the **Floquet matrix**, and the determinant condition $|\mathbf{C}| = 1 \implies \lambda_1\lambda_2 = 1$; they are the roots of the characteristic quadratic equation

$$\lambda^2 - b(E)\lambda + 1 = 0, \quad b(E) = \text{trace}(\mathbf{C}(E)). \quad (6.3.1.3)$$

The solutions depend on whether $b(E)^2 - 4 \leq 0$.

(i) $b(E)^2 < 4$

The roots are complex conjugates of unit magnitude. So we can write

$$\lambda_1 = e^{ika}, \quad \lambda_2 = e^{-ika}. \quad (6.3.1.4)$$

These solutions correspond to a delocalized state since $|\psi_i(x + na)| = |\psi_i(x)|$ $n \in \mathbb{Z}$ and so the probability of finding the particle in the neighbourhood of any site is the same. This is the Bloch wave solution which is a travelling wave.

(ii) $b(E)^2 > 4$

The roots are real and the reciprocals of each other. So we can write

$$\psi_1(x) = e^{\mu x}u(x), \quad \psi_2(x) = e^{-\mu x}u(x), \quad (6.3.1.5)$$

with μ real. These are not acceptable wavefunctions as they are unbounded in $-\infty < x < \infty$.

Thus we find that a band structure naturally appears and corresponds to allowed energies, E , determined by the condition on the Floquet matrix that $\text{trace}(\mathbf{C}(E))^2 < 4$. All E for which $\text{trace}(\mathbf{C}(E))^2 > 4$ are forbidden. (Some small extra amount of analysis is needed for the degenerate case $b(E)^2 = 4$ where $\lambda_1 = \lambda_2 = \pm 1$. These correspond to the lower and upper energies of the allowed band.)

To determine $\mathbf{C}(E)$ in a particular circumstance, the wavefunctions $\psi_i(x + a)$ must be matched to $\psi_i(x)$ using continuity conditions appropriate to the potential.

6.1.4 Brillouin Zones

Clearly, the range of k is $-\pi/a < k \leq \pi/a$. This is called the **first Brillouin zone** B_1 , or often just the **Brillouin zone**, in k space. Clearly, the wavevector $k_n = 2n\pi/a + k$ with $k \in B_1$ labels the same state as does k ; they correspond to the same energy because of periodicity and also the same eigenstate of the translation operator. Thus the k -values labelling distinct states may be confined to the first Brillouin zone. It is sometimes convenient to define the n -th Brillouin zone, B_n as

$$B_n = \{k : k_1 = k - 2n\pi/a \in B_1 \text{ or } k_1 = k + 2n\pi/a \in B_1\}, \quad (6.4.1.1)$$

i.e., it contains those values of k that translated to k_1 by either $2n\pi/a$ or $-2n\pi/a$, then belong to the first Brillouin zone. Note that k_1 is **equivalent** to k because they label the **same** Bloch eigenfunction.

The graph of $E(k)$ versus k identifying the 1st and 2nd Brillouin zones is

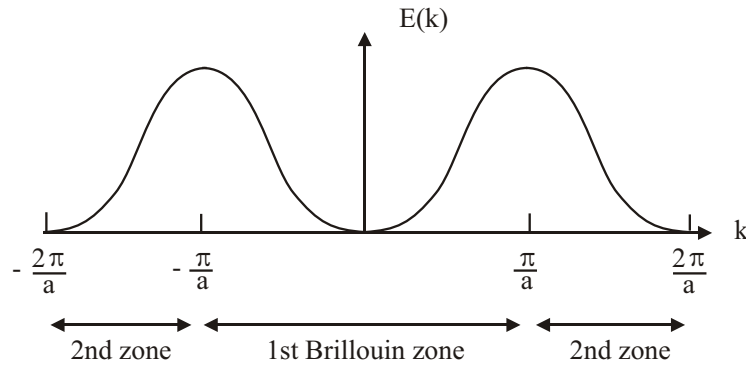

Clearly, the k values in any one Brillouin zone are a complete set of allowed quantum numbers labelling the Bloch states whose energy eigenvalues are given as a function of k by the **dispersion relation** in eqn. (6.1.1.8).

It is important to notice that the first Brillouin zone is identical to the Voronoi or Wigner-Seitz cell of the reciprocal lattice. The reciprocal lattice in this case is generated by the basis vector $b = 2\pi/a$ and the Voronoi cell consists of all points $\{x : -b/2 < x < b/2\}$. We shall see that for the generalization to $D = 2, 3$ this result still holds. Thus the **Brillouin zone** is another name for the Voronoi cell of the reciprocal lattice.

6.1.5 The Nearly-Free Electron Model

We shall consider an electron moving in a weak periodic potential V of period a . When the potential $V = 0$ the electron is free but we can still ask how we describe its plane wave states from the lattice perspective. Then as above

$$\Lambda = \{x : x = na, n \in \mathbb{Z}\}, \quad \Lambda^* = \{k : k = nb, b = 2\pi/a, n \in \mathbb{Z}\}. \quad (6.5.1.1)$$

Have

$$H = \frac{p^2}{2m}, \quad \psi_k(x) = e^{ikx}, \quad E(k) = \frac{\hbar^2 k^2}{2m}. \quad (6.5.1.2)$$

We can view the plot of $E(k)$ versus k in two ways.

(i) **Extended zone scheme**

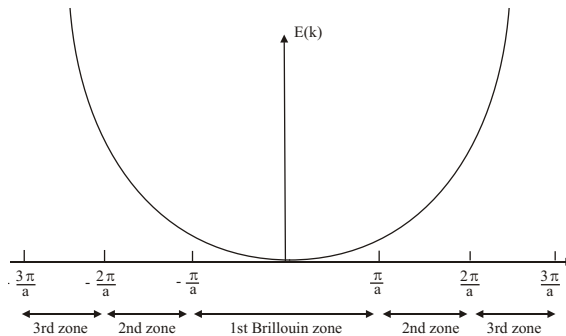

Partition the k axis into Brillouin zones but otherwise the plot is standard. The full, and expected, range of k is associated with the set of all Brillouin zones and $E(k)$ is a single-valued function of k .

(ii) **Reduced zone scheme**

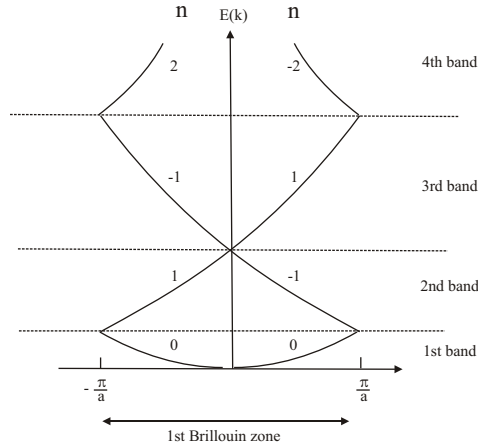

The wavevector k is restricted to the 1st Brillouin zone and $E(k)$ is a multivalued function of k . The different curves are labelled by $n \in \mathbb{Z}$ with

$$E(k) = \frac{\hbar^2}{2m} \left(k + \frac{2\pi n}{a} \right)^2 \quad -\frac{\pi}{a} < k \leq \frac{\pi}{a}. \quad (6.5.1.3)$$

Then

$$\begin{aligned} \psi_{n,k}(x) &= e^{i(k + 2\pi n/a)x} = e^{ikx} u_n(x) \\ \text{with } u_n(x) &= e^{2in\pi x/a}. \end{aligned} \quad (6.5.1.4)$$

Here we see the explicit reformulation in terms of Bloch states. In this simple case u_n is independent of k . The **reduced zone scheme** generalizes to higher dimensions and general lattices. Here we see that each curve is labelled by a vector from the reciprocal lattice $q = nb \equiv 2n\pi/a$ and then

$$E_q(k) = \frac{\hbar^2}{2m} (k + q)^2. \quad (6.5.1.5)$$

We now take V to be non-zero but weak. The electron is considered to be "nearly" free, and we investigate the energy eigenvalues and eigenfunctions of the system but treating V as a periodic perturbation of the Hamiltonian for the free electron and so use a perturbation theory analysis.

Consider a large (1D) crystal of N unit cells and with lattice spacing a :

$$\Lambda = \left\{ l : l = na, \quad n = -\frac{N}{2} + 1 \dots 0 \dots \frac{N}{2} \right\}. \quad (6.5.1.6)$$

Impose periodic boundary conditions on the wavefunction

$$\psi_k(x + Na) = \psi_k(x), \quad (6.5.1.7)$$

and since $\psi_k(x+l) = e^{ikl}\psi_k(x)$ we must have $k = 2\pi m/Na$, $m \in \mathbb{Z}$; the first Brillouin zone is $-N/2 < m \leq N/2$. Have

$$H_0 = \frac{p^2}{2m}, \quad V(x+na) = V(x), \quad n \in \mathbb{Z}. \quad (6.5.1.8)$$

Eigenstates of H_0 are denoted by $|k\rangle$ with wavefunction

$$\phi_k(x) = \frac{1}{\sqrt{Na}} e^{ikx}, \quad E_0(k) = \frac{\hbar^2 k^2}{2m}, \quad (6.5.1.9)$$

with

$$\langle k'|k\rangle = \frac{1}{Na} \int_0^{Na} dx e^{i(k-k')x} = \delta_{k,k'}. \quad (6.5.1.10)$$

For given k the unperturbed energy is $E_0(k)$. The perturbed energy $E(k)$ is given by

$$E(k) = E_0(k) + \langle k|V|k\rangle + \sum_{k' \neq k} \frac{\langle k|V|k'\rangle \langle k'|V|k\rangle}{E_0(k) - E_0(k')} + \dots \quad (6.5.1.11)$$

We need to calculate $\langle k'|V|k\rangle$. Because $V(x)$ is periodic we have

$$\begin{aligned} V(x) &= \sum_q V_q e^{iqx}, \quad V_{-q} = V_q^*, \quad q \in \Lambda^*, \\ V_q &= \frac{1}{a} \int_0^a dx e^{-iqx} V(x). \end{aligned} \quad (6.5.1.12)$$

Then have

$$\begin{aligned} \langle k|V|k\rangle &= \frac{1}{Na} \int_0^{Na} dx e^{-ikx} V(x) e^{ikx} = V_0, \\ \langle k'|V|k\rangle &= \frac{1}{Na} \int_0^{Na} dx e^{i(k-k')x} V(x) \\ &= \sum_q V_q \frac{1}{Na} \int_0^{Na} dx e^{i(k-k'+q)x} \\ &= \begin{cases} 0 & k' - k \notin \Lambda^* \\ V_q & k' - k = q \in \Lambda^*. \end{cases} \end{aligned} \quad (6.5.1.13)$$

If $k' - k = q \in \Lambda^*$ then also have $\langle k|V|k'\rangle = V_q^*$. Thus, explicitly to second order in perturbation theory, have

$$E(k) = E_0(k) + \langle k|V|k\rangle + \sum_{\substack{q \in \Lambda^* \\ q \neq 0}} \frac{|V_q|^2}{E_0(k) - E_0(k+q)} + \dots \quad (6.5.1.14)$$

When does this perturbation series break down? Look at the second-order term. It **breaks down** at those values of k for which

$$E_0(k) = E_0(k+q), \quad q \in \Lambda^* \quad q \neq 0. \quad (6.5.1.15)$$

This means that V can cause a transition between the **degenerate** states $|k\rangle$ and $|k+q\rangle$. In the extended scheme, appropriate to this calculation, since we are perturbing about the free particle plane wave states, we have the degeneracy points:

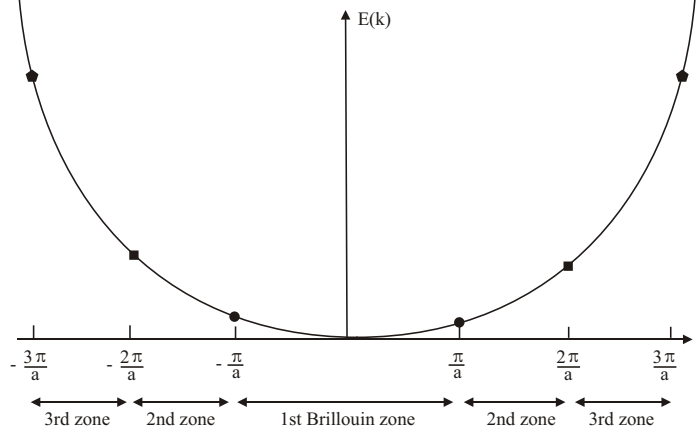

In the reduced scheme the degeneracy points are at the **edges** and the **centre** of the Brillouin zone. For this model the degeneracy points are for states $|k\rangle$ and $|k'\rangle$ with

$$k = -\frac{1}{2}q, \quad k' = \frac{1}{2}q, \quad E = \frac{\hbar^2 q^2}{8m}, \quad q \in \Lambda^*. \quad (6.5.1.16)$$

Degenerate perturbation theory. To resolve the degeneracy problem we must use degenerate perturbation theory. In the subspace of degenerate states, we must choose that basis for which matrix elements of V are diagonal when restricted to that subspace. In this case, the offending terms in second-order perturbation theory do not appear.

Consider the unperturbed state $|\frac{1}{2}q + \varepsilon\rangle$, $q \in \Lambda^*$, where ε is small. This will mix strongly with $|\frac{1}{2}q - \varepsilon\rangle$ since the energies of both states are **nearly equal**. Write the perturbed state as

$$|\psi\rangle = \alpha_+ |\frac{1}{2}q + \varepsilon\rangle + \alpha_- |\frac{1}{2}q - \varepsilon\rangle + \sum'_{b \in \Lambda^*} \alpha_b |\frac{1}{2}q + b + \varepsilon\rangle, \quad (6.5.1.17)$$

where \sum' means exclude the two nearly degenerate states from the sum over $b \in \Lambda^*$; i.e., exclude $b = 0, -q$. Using eqn. (6.5.1.13) we recognize that this expansion contains all the states that can appear since the wavevectors of all the states that mix must differ by $b \in \Lambda^*$; we have simply selected the case where two states are almost degenerate and then highlighted them. The coefficients α_b are $O(V)$ and so, in the spirit of perturbation theory, are small and calculable using the non-degenerate perturbation theory above. We shall omit them from now on.

Denote

$$|+\rangle = |\frac{1}{2}q + \varepsilon\rangle, \quad |-\rangle = |\frac{1}{2}q - \varepsilon\rangle, \quad E_{\pm}^{(0)} = \frac{\hbar^2 q^2}{8m} \pm \varepsilon \frac{\hbar q}{2m}. \quad (6.5.1.18)$$

Then $H|\psi\rangle = E|\psi\rangle \implies$

$$(H_0 + V)(\alpha_+ |+\rangle + \alpha_- |-\rangle) = E(\alpha_+ |+\rangle + \alpha_- |-\rangle). \quad (6.5.1.19)$$

$$\begin{aligned} \langle + | & \\ & \left(E_+^{(0)} \alpha_+ + \langle + | V | + \rangle \alpha_+ + \langle + | V | - \rangle \alpha_- \right) = E \alpha_+ \\ \langle - | & \\ & \left(E_-^{(0)} \alpha_- + \langle - | V | - \rangle \alpha_- + \langle - | V | + \rangle \alpha_+ \right) = E \alpha_-. \end{aligned} \quad (6.5.1.20)$$

But

$$\begin{aligned} \langle +|V|+ \rangle &= \langle -|V|- \rangle = V_0, \\ \langle +|V|- \rangle &= V_q, \quad \langle -|V|+ \rangle = V_q^*. \end{aligned} \quad (6.5.1.21)$$

Then

$$\underbrace{\begin{pmatrix} E_+^{(0)} + V_0 - E & V_q \\ V_q^* & E_-^{(0)} + V_0 - E \end{pmatrix}}_{\mathbf{M}(E)} \begin{pmatrix} \alpha_+ \\ \alpha_- \end{pmatrix} = \mathbf{0}. \quad (6.5.1.22)$$

Then E is determined by $\det(\mathbf{M}(E)) = 0$. This gives a quadratic equation with roots

$$E_{\pm} = \frac{(E_+^{(0)} + E_-^{(0)}) \pm \sqrt{(E_+^{(0)} - E_-^{(0)})^2 + 4|V_q|^2}}{2} + V_0. \quad (6.5.1.23)$$

Important:

$$\begin{aligned} \text{As } V \rightarrow 0: \quad E_+ &\rightarrow E_+^{(0)}, \quad E_- \rightarrow E_-^{(0)}. \\ \text{For } V \neq 0: \quad E_+ &> E_+^{(0)}, \quad E_- < E_-^{(0)}. \end{aligned} \quad (6.5.1.24)$$

I.e., the effect of the potential V is that **the levels move apart** (always the case):

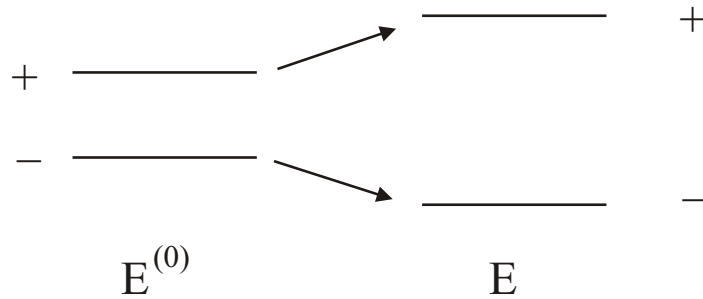

Consider two cases:

(i) $E_+^{(0)} - E_-^{(0)} \gg 2|V_q|$

$$\sqrt{(E_+^{(0)} - E_-^{(0)})^2 + 4|V_q|^2} = (E_+^{(0)} - E_-^{(0)}) \left(1 + \frac{2|V_q|^2}{(E_+^{(0)} - E_-^{(0)})^2} + \dots \right), \quad (6.5.1.25)$$

or

$$E_{\pm} = E_{\pm}^{(0)} + V_0 \pm \frac{|V_q|^2}{(E_+^{(0)} - E_-^{(0)})} + \dots \quad (6.5.1.26)$$

I.e., just recover **non-degenerate perturbation theory** result.

(ii) $E_+^{(0)} - E_-^{(0)} \ll 2|V_q|$. I.e., $\varepsilon \rightarrow 0$ corresponding to degeneracy.

$$E_{\pm} \approx \frac{E_+^{(0)} - E_-^{(0)}}{2} + V_0 \pm |V_q|. \quad (6.5.1.27)$$

Or

$$E_{\pm} \approx \frac{\hbar^2 q^2}{8m} + V_0 \pm |V_q|. \quad (6.5.1.28)$$

The two degenerate states split and the **energy gap** is

$$\Delta E_q = E_+ - E_- = 2|V_q|. \quad (6.5.1.29)$$

A gap opens up at the points of degeneracy. The features to remember are

(a) The degenerate states have wavevectors which differ by a reciprocal lattice vector.

$$\begin{aligned} &|k\rangle \quad |k+q\rangle, && \left\{ \begin{array}{l} \text{The potential, being periodic, has non-zero} \\ \text{matrix elements only between such states.} \end{array} \right. \\ &k^2 = (k+q)^2, \quad q \in \Lambda^*, && \text{The condition for degeneracy.} \end{aligned} \quad (6.5.1.30)$$

(b) The consequence of (a) is that degenerate states lie at the **edges** of the Brillouin zones in the **extended scheme**, or at the **edges** and **centre** of the Brillouin zone in the **reduced scheme**.

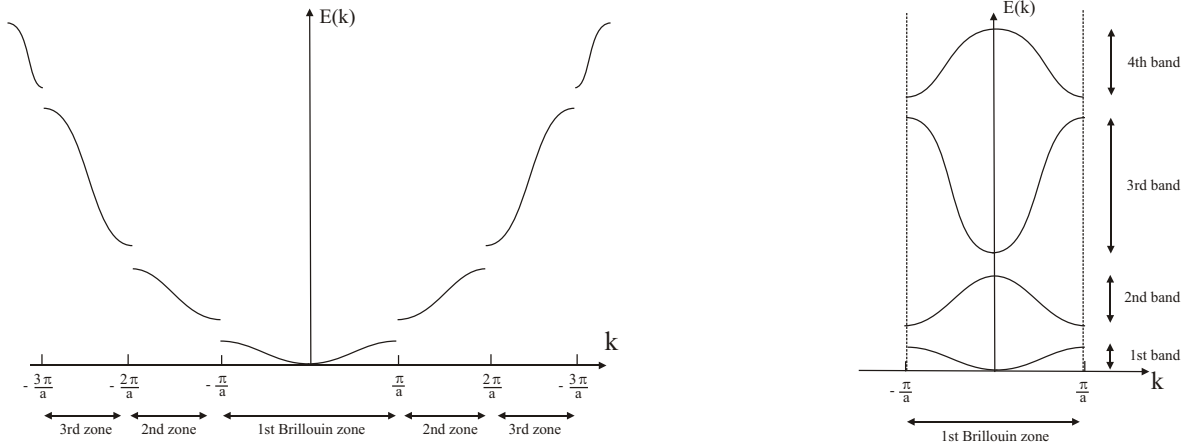

The gap between the n -th and $(n+1)$ -th band is ΔE_n with

$$\Delta E_n = 2|V_{q_n}|, \quad q_n = \frac{2n\pi}{a} \in \Lambda^*. \quad (6.5.1.31)$$

7 Particle in a 3-Dimensional Periodic Potential

Much of what we have understood about a particle in a 1D periodic potential generalizes to three dimensions.

7.1 Bloch's Theorem

Let $\mathbf{l} \in \Lambda$, $\mathbf{l} = l_i \mathbf{a}_i$, $l_i \in \mathbb{Z}$ $i = 1, 2, 3$.

Let $\mathbf{k} \in \Lambda^*$, $\mathbf{k} = k_i \mathbf{b}_i$, $k_i \in \mathbb{Z}$ $i = 1, 2, 3$. (7.1.1)

Note that \mathbf{k} is a vector in reciprocal space. The energy eigenfunction $\psi(\mathbf{r})$ is labelled by k_1, k_2, k_3 or equivalently \mathbf{k} . Then

$$\psi_{\mathbf{k}}(\mathbf{r} + \mathbf{l}) = e^{i\mathbf{k} \cdot \mathbf{l}} \psi_{\mathbf{k}}(\mathbf{r}). \quad (7.1.2)$$

Bloch's theorem states that in a system which is translation invariant under $\{\mathbf{r} \rightarrow \mathbf{r} + \mathbf{l} : \mathbf{l} \in \Lambda\}$, the energy eigenfunctions can be written in the form

$$\begin{aligned} \psi_{\mathbf{k}}(\mathbf{r}) &= e^{i\mathbf{k} \cdot \mathbf{r}} u_{\mathbf{k}}(\mathbf{r}), \\ \text{where } P_i \psi_{\mathbf{k}}(\mathbf{r}) &= k_i \psi_{\mathbf{k}}(\mathbf{r}), \quad \mathbf{k} = k_i \mathbf{b}_i \in \Lambda^*, \\ \text{and } u_{\mathbf{k}}(\mathbf{r} + \mathbf{l}) &= u_{\mathbf{k}}(\mathbf{r}) : \quad u_{\mathbf{k}}(\mathbf{r}) \text{ is a periodic function} \end{aligned} \quad (7.1.3)$$

Proof:

We are always free to **define** $u_{\mathbf{k}}(\mathbf{r})$ by

$$\psi_{\mathbf{k}}(\mathbf{r}) = e^{i\mathbf{k} \cdot \mathbf{r}} u_{\mathbf{k}}(\mathbf{r}), \quad (7.1.4)$$

and then

$$\psi_{\mathbf{k}}(\mathbf{r} + \mathbf{l}) = e^{i\mathbf{k} \cdot \mathbf{l}} e^{i\mathbf{k} \cdot \mathbf{r}} u_{\mathbf{k}}(\mathbf{r} + \mathbf{l}). \quad (7.1.5)$$

But, from above

$$\begin{aligned} \psi_{\mathbf{k}}(\mathbf{r} + \mathbf{l}) &= e^{i\mathbf{k} \cdot \mathbf{l}} \psi_{\mathbf{k}}(\mathbf{r}) \implies \\ u_{\mathbf{k}}(\mathbf{r} + \mathbf{l}) &= u_{\mathbf{k}}(\mathbf{r}). \quad QED \end{aligned} \quad (7.1.6)$$

7.2 Ambiguities in \mathbf{k}

We have seen already that in 1D the distinct values of the wavevector k can be taken to be those in the first Brillouin zone or, equivalently, the Wigner-Seitz or Voronoi cell of the reciprocal lattice. This generalizes to $D > 1$ as follows.

Suppose $\mathbf{q} \in \Lambda^*$, $\mathbf{q} = q_i \mathbf{b}_i$, $q_i \in \mathbb{Z}$ and let $\mathbf{k}' = \mathbf{k} + \mathbf{q}$. Then

$$\psi_{\mathbf{k}'}(\mathbf{r} + \mathbf{l}) = e^{i\mathbf{k}' \cdot \mathbf{l}} \psi_{\mathbf{k}'}(\mathbf{r}) = e^{i\mathbf{k} \cdot \mathbf{l}} e^{i\mathbf{q} \cdot \mathbf{l}} \psi_{\mathbf{k}'}(\mathbf{r}). \quad (7.2.1)$$

But $e^{i\mathbf{q} \cdot \mathbf{l}} = 1$ since $\mathbf{q} \cdot \mathbf{l} = 2\pi m$, $m \in \mathbb{Z}$. Hence,

$$\psi_{\mathbf{k}'}(\mathbf{r} + \mathbf{l}) = e^{i\mathbf{k} \cdot \mathbf{l}} \psi_{\mathbf{k}'}(\mathbf{r}), \quad (7.2.2)$$

and so $\psi_{\mathbf{k}'}(\mathbf{r})$ could equally well be labelled by the vector \mathbf{k} instead of \mathbf{k}' . It follows that for **classification** purposes \mathbf{k} and \mathbf{k}' are equivalent if $\mathbf{k} - \mathbf{k}' \in \Lambda^*$.

This ambiguity is resolved by restricting \mathbf{k} to lie in a representative set, and a standard choice is to restrict \mathbf{k} to lie in the Wigner-Seitz, or Voronoi, cell of the reciprocal lattice. For **any** wavevector \mathbf{k} there exists $\mathbf{q} \in \Lambda^*$ such that $\mathbf{k}' = \mathbf{k} - \mathbf{q}$ lies in the Voronoi cell. \mathbf{k}' and \mathbf{k} are equivalent labels (or quantum numbers) for the energy eigenstate. This is the **first Brillouin zone** and defines the **reduced zone scheme**.

7.3 The Nearly Free Electron Model in 3D

Armed with the definition of the Brillouin zone as the **Voronoi** or **Wigner-Seitz** cell of Λ^* we can easily extend the band structure calculation for the $D = 1$ nearly free electron model to $D = 3$.

$$(1) \quad V(\mathbf{x} + \mathbf{l}) = V(\mathbf{x}), \quad \mathbf{l} \in \Lambda \implies V(\mathbf{x}) = \sum_{\mathbf{q} \in \Lambda^*} V_{\mathbf{q}} e^{i\mathbf{q} \cdot \mathbf{x}}. \quad (7.3.1)$$

(2) Non-degenerate perturbation theory is adequate **unless**

$$E(\mathbf{k}) = E(\mathbf{k} + \mathbf{q}), \quad \mathbf{q} \in \Lambda^* \text{ and } V_{\mathbf{q}} \neq 0. \quad (7.3.2)$$

In the nearly free particle model we get

$$k^2 = |\mathbf{k} + \mathbf{q}|^2 \implies 2\mathbf{k} \cdot \mathbf{q} + q^2 = 0. \quad (7.3.3)$$

In the **extended zone scheme** the wavevectors \mathbf{k} satisfying this condition lie on the **boundaries** between zones.

In the **reduced zone scheme** the wavevectors \mathbf{k} satisfying this condition lie on the **boundary** of the zone and at its **centre**.

(3) The degeneracy is two-fold on the zone surface but can be, and generally is, higher on zone edges and corners. For N -fold degeneracy the determinantal condition is applied to an $N \times N$ matrix and so the details of the energy gap will be different depending on the nature of the degeneracy and dimension, N , of the space of degenerate states.

(4) The condition for **Bragg scattering** from \mathbf{k} to \mathbf{k}' is

$$E(\mathbf{k}) = E(\mathbf{k}') \text{ and } \mathbf{k}' = \mathbf{k} + \mathbf{q}, \quad \mathbf{q} \in \Lambda^*. \quad (7.3.4)$$

Hence, the **energy gaps** occur for just those \mathbf{k} which satisfy the Bragg condition and hence for which **strong** scattering occurs.

Electrons with these values of \mathbf{k} cannot move as plane waves through the lattice since they are continually rescattering and suffering interference. E.g., in $D = 1$ the eigenvectors at the **degeneracy point** are

$$\frac{1}{\sqrt{2}} (|\frac{1}{2}q\rangle \pm |-\frac{1}{2}q\rangle), \quad (7.3.5)$$

with eigenfunctions

$$\sqrt{\frac{2}{V}} \cos(\frac{1}{2}qx), \quad \sqrt{\frac{2}{V}} \sin(\frac{1}{2}qx). \quad (7.3.6)$$

I.e., **standing waves**. These carry **no current** as they are real: $j = \frac{\hbar}{m} \text{Im}(\psi^* \psi') = 0$.

7.4 The Tight-Binding Model in 3D

As in 1D we consider electrons tightly bound to atomic centres at the sites \mathbf{l} of the lattice Λ . Suppose the Hamiltonian for the electron in an isolated atom at the origin is $H_0(\mathbf{x})$ with potential $V_0(\mathbf{x})$, and its energy eigenfunction for a **chosen** state is $\psi(\mathbf{x})$. Also have

$$H_0\psi(\mathbf{x}) \equiv \left(-\frac{\hbar^2}{2m}\nabla^2 + V_0(\mathbf{x}) \right) \psi(\mathbf{x}) = E_0\psi(\mathbf{x}). \quad (7.4.1)$$

The Hamiltonian for the electron in the lattice is then

$$H = H_0 + V(\mathbf{x}), \quad (7.4.2)$$

where $V(\mathbf{x})$ is the potential due to the proximity of atoms at all lattice sites **other** than the origin $\mathbf{l} = \mathbf{0}$. Of course, I can choose the origin w.l.o.g., but could have also singled out any other site; the full expression for H would be the same:

$$H = -\frac{\hbar^2}{2m}\nabla^2 + \sum_{\mathbf{l} \in \Lambda} V_0(\mathbf{x} - \mathbf{l}). \quad (7.4.3)$$

The potential here is clearly periodic.

We consider the variational choice for the electron wavefunction in the same manner as before

$$\Psi_{\mathbf{k}}(\mathbf{x}) = \sum_{\mathbf{l} \in \Lambda} e^{i\mathbf{k} \cdot \mathbf{l}} \psi_{\mathbf{l}}(\mathbf{x}), \quad (7.4.4)$$

where $\psi_{\mathbf{l}}(\mathbf{x}) = \psi(\mathbf{x} - \mathbf{l})$. We also assume that the only significant non-zero matrix elements are

$$\langle \psi_{\mathbf{l}} | V | \psi_{\mathbf{l}} \rangle = \alpha, \quad \langle \psi_{\mathbf{l}} | V | \psi_{\mathbf{l} \pm \mathbf{a}} \rangle = -\gamma_{\pm \mathbf{a}} \quad \mathbf{a} \in \text{basis of unit cell}. \quad (7.4.5)$$

In particular we take $\langle \psi_{\mathbf{l}} | \psi_{\mathbf{l}'} \rangle = \delta_{\mathbf{l}, \mathbf{l}'}$ (we could relax this condition but it has no significant effect on the outcome). It is clear from translation invariance that $\gamma_{-\mathbf{a}} = \gamma_{\mathbf{a}}^*$. Then have

$$H\Psi_{\mathbf{k}}(\mathbf{x}) = E(\mathbf{k})\Psi_{\mathbf{k}}(\mathbf{x}) = (H_0 + V(\mathbf{x})) \sum_{\mathbf{l} \in \Lambda} e^{i\mathbf{k} \cdot \mathbf{l}} \psi_{\mathbf{l}}(\mathbf{x}). \quad (7.4.6)$$

W.l.o.g. can take matrix elements by multiplying by $\psi_{\mathbf{0}}^*(\mathbf{x})$ and integrating. We find

$$E(\mathbf{k}) = (E_0 + \alpha) - \sum_{\mathbf{a} \in \text{basis}} \left(\gamma_{\mathbf{a}} e^{i\mathbf{k} \cdot \mathbf{a}} + \gamma_{\mathbf{a}}^* e^{-i\mathbf{k} \cdot \mathbf{a}} \right). \quad (7.4.7)$$

Clearly, as discussed earlier, only wavevectors in the first Brillouin zone are inequivalent since $E(\mathbf{k} + \mathbf{q}) = E(\mathbf{k})$, $\mathbf{q} \in \Lambda^*$. The first Brillouin zone is, to reiterate, the Voronoi cell of the reciprocal lattice.

- (i) The original N degenerate atomic states were localized but the new states $\Psi_{\mathbf{k}}(\mathbf{x})$ are extended.
- (ii) **Each** energy level in the atom gives rise to a band as discussed in 1D. These bands can be labelled by the originating level quantum numbers and can be plotted in the **reduced zone scheme** just as is done in the nearly free model.

As an example, consider a cubic lattice with unit cell of side a . Then by symmetry, for the n -th level, we have $\gamma_{\mathbf{a}} \equiv \gamma_n$ for \mathbf{a} joining nearest neighbours. Take γ_n to be real and then the dispersion relation for the n -th band is

$$E_n(\mathbf{k}) = E_n - 2\gamma_n(\cos k_1 a + \cos k_2 a + \cos k_3 a), \quad (7.4.8)$$

with band width $12\gamma_n$.

7.4.1 Energy Contours

The plot of $E(\mathbf{k})$ versus \mathbf{k} is complicated and is best thought of as surfaces of constant E in 3D \mathbf{k} -space, and restricted to the first Brillouin zone in the reduced scheme. As we have seen, this is a Voronoi cell which is a complicated shape. Contours of constant energy for a cubic reciprocal lattice and for both tight-binding and nearly free models in 2D are

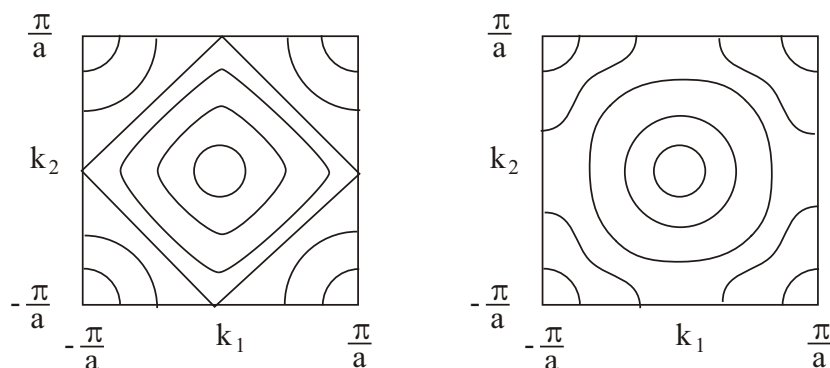

Note how the different degeneracies on edges and corners causes different energy splitting and so affects the energy values there.

8 Electronic Properties

Electrons in the crystal obey the **Pauli Exclusion Principle** and at $T = 0$ they fill the lowest available energy eigenstates in the bands up to energy E_F , the Fermi energy. All states with $E < E_F$ are filled and those with $E > E_F$ are empty.

We can count the number of states in each band. Consider a finite size crystal with N sites and one atom per unit cell, and so N atoms in total.

- (a) In the tight-binding model each atomic energy shell corresponds to an energy band in the crystal. The N copies of a given shell combine, because of tunnelling, into a band of states. Suppose there are s energy levels in a shell, then the band will contain $2sN$ states, where the factor of 2 is for spin degeneracy \uparrow, \downarrow .
- (b) In the nearly free model and for a crystal of length Na in 1D we can impose periodic boundary conditions on the Bloch waves. Then the allowed values of k satisfy

$$e^{ikNa} = 1 \implies k = \frac{2\pi m}{Na}, \quad -\frac{N}{2} < m \leq \frac{N}{2}. \quad (8.1)$$

I.e., there are N distinct Bloch states labelled by m in the band and so $2N$ states after accounting for spin.

For a partially filled band in $D > 1$ there is an energy surface contour $E = E_F$ in the corresponding Brillouin zone. At $T = 0$ it separates the filled states from the empty states and is called the **Fermi surface**.

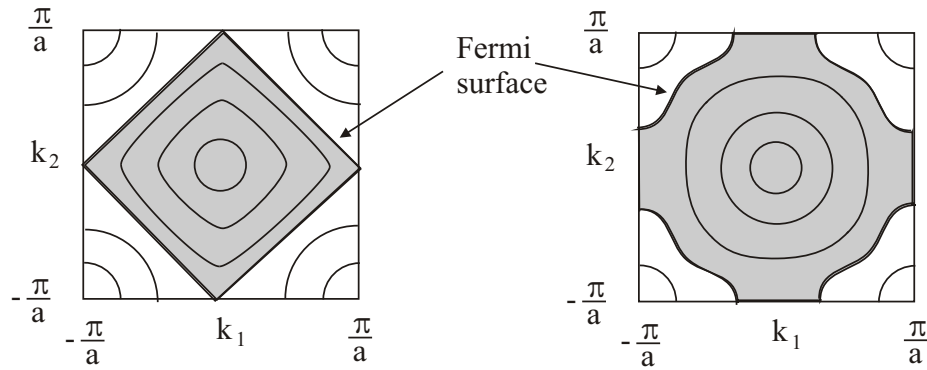

8.1 The Effect of Temperature

At $T = 0$ the electrons filling the bands occupy the lowest possible states consistent with the Pauli Principle. The probability that a given state is occupied is thus either 1 or 0: $P(E < E_F) = 1$, $P(E > E_F) = 0$. In practice, always have $T > 0$ and so there is a probability that the energy of an electron can fluctuate by amounts typically of order $k_B T$ where k_B is Boltzmann's constant. The filling probability is now changed but, in practice, not by very much. Typical values for the energies concerned are

$$E_F \sim 2-4 \text{ eV}, \quad k_B T \sim 8.617 \cdot 10^{-5} \times 300 \text{ } ^\circ K \sim 0.026 \text{ eV} \implies k_B T \ll E_F. \quad (8.1.1)$$

E_F is typical of the energy scales in the isolated atom. We expect the occupation probability as a function of T for reasonable values to look like

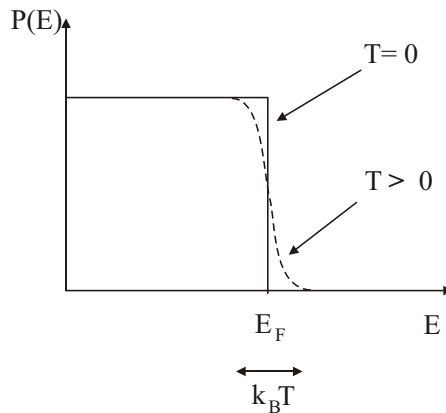

The effect of temperature is exaggerated here so as to display the difference from $T = 0$ more clearly. Thus for most purposes we can ignore effects due to non-zero T . The functional form for $P(E)$ is the **Fermi-Dirac distribution**

$$P(E) = \frac{1}{1 + e^{(E-E_F)/k_B T}}. \quad (8.1.2)$$

8.2 Insulators and Conductors

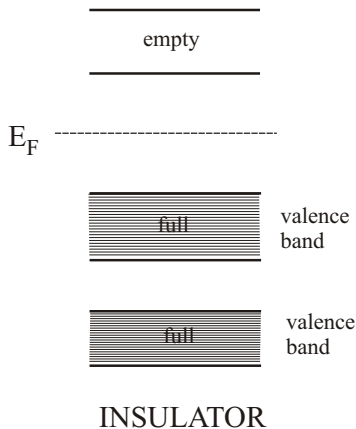

(i) **Insulators** contain atoms in which the electrons occupy **closed shells**. The atoms in an insulator have just the right number of electrons to fill all the shells with no electrons left over. The corresponding bands are completely filled. Typically materials with valency zero or divalent. E_F lies in the gap above the highest filled band. The situation can change if bands overlap but always **insulator = filled bands**. [Note that for $T > 0$, $P(E_F) = 1/2$. This condition conversely fixes the value of E_F .]

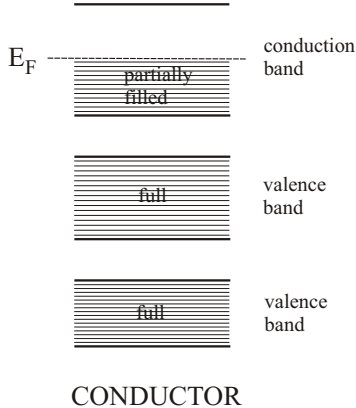

(ii) **Conductors** contain atoms in which the lower-lying energy shells are closed but the last (i.e., highest energy) occupied shell is **not** closed. Correspondingly, the lower-lying bands are **full** but the **top** band is only partially filled. Typically these materials are metals in which, for example, the outer shell with $l = 0$ has room for two electrons of spin \uparrow, \downarrow but is occupied by one electron only. In this case the uppermost, or **conduction band** is half full and E_F is in the middle of the band. Typically valency one.

The lower bands, which are full, are called **valence bands**.

Why is this?

8.2.1 Dynamics

When a particle has plane-wave stationary states it has equal probability of being found anywhere. To localize it we form a wavepacket. Consider superposing two plane waves with momenta $\hbar(k \pm \Delta k)$ with energy dispersion $E(k) = \hbar\omega(k)$. Let $\Delta\omega = \frac{d\omega}{dk}\Delta k$ and then the wavefunction is:

$$\psi(x, t) = \sqrt{\frac{1}{2V}} \left(e^{i(k + \Delta k)x - i(\omega + \Delta\omega)t} + e^{i(k - \Delta k)x - i(\omega - \Delta\omega)t} \right). \quad (8.1.2.1)$$

The **observable** quantity is $|\psi(x, t)|^2$ which is clearly given by

$$|\psi(x, t)|^2 = \frac{1}{V} (1 + \cos 2(\Delta k x - \Delta\omega t)) = \frac{2}{V} \cos^2(\Delta k x - \Delta\omega t). \quad (8.1.2.2)$$

The velocity of this wave-packet is given by following points of constant $|\psi(x, t)|^2$ as t changes. From above this means $\Delta k x - \Delta\omega t = \text{constant}$, i.e., keep the phase

constant. Thus the velocity is given by

$$v = \frac{dx}{dt} = \frac{\Delta\omega}{\Delta k} = \frac{d\omega(k)}{dk} . \quad \text{The group velocity.} \quad (8.1.2.3)$$

The **group velocity** is the **observable** velocity of particles.

In a band, the group velocity of the electron in state labelled by wavenumber k is

$$v = \frac{d\omega(k)}{dk} = \frac{1}{\hbar} \frac{dE(k)}{dk} . \quad (8.1.2.4)$$

This is the velocity at which the charge carried by the electron is transported.

Consider an applied electric field \mathcal{E} . The force on the electron of charge q is $F = q\mathcal{E}$, and so the change in energy of the electron is

$$dE = Fdx = q\mathcal{E}v dt . \quad (8.1.2.5)$$

Substituting the group velocity for v , we get

$$dE = \frac{q}{\hbar} \mathcal{E} \frac{dE(k)}{dk} dt . \quad (8.1.2.6)$$

We can reinterpret this result in terms of a time-dependent k :

$$dE = \frac{dE(k)}{dk} dk \Rightarrow \boxed{\frac{dk}{dt} = \frac{q}{\hbar} \mathcal{E}} . \quad (8.1.2.7)$$

This is what we expect **classically** since the momentum is $\hbar k$ and

$$\frac{d \text{ momentum}}{dt} = \text{applied force} .$$

Since k changes with time the electron **must** be continually making the transition to states of more positive k (taking $\mathcal{E} > 0$ w.l.o.g.). From above

$$\dot{v} = \frac{1}{\hbar} \frac{d}{dt} \frac{dE}{dk} = \frac{1}{\hbar} \left(\dot{k} \frac{d}{dk} \right) \frac{dE}{dk} = \frac{1}{\hbar} \dot{k} \frac{d^2 E}{dk^2} = \frac{q}{\hbar^2} \frac{d^2 E}{dk^2} \mathcal{E} , \quad (8.1.2.8)$$

using \dot{k} from eqn. (8.1.2.7). Can write as an **effective** Newton's law

$$m^* \dot{v} = q\mathcal{E} , \quad \text{with} \quad m^* = \hbar^2 \left(\frac{d^2 E}{dk^2} \right)^{-1} , \quad \text{the effective mass.} \quad (8.1.2.9)$$

Thus we can treat many calculations as classical as long as we use an **effective mass**, m^* , for the electron. For **any** band the major features are:

- (i) $m^* > 0$ at bottom of band and $m^* < 0$ at top of band.
- (ii) Under an applied field the velocity of an electron starting from $k = 0$, $v = 0$ **increases** to its maximum at $k = \pi/2a$, and then it **decreases** again reaching $v = 0$ at the zone boundary. By periodicity, k **re-enters** the zone at $k = -\pi/a$. In general, **symmetry** requires $v = dE/dk = 0$ at the top and bottom of the band.

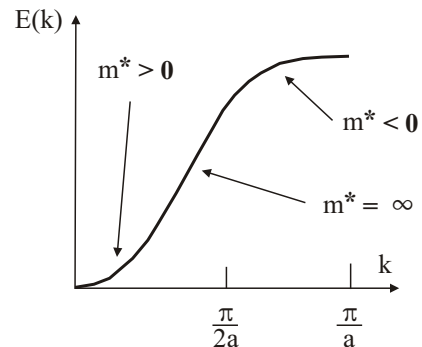

Now consider a simple filling of energy levels in the Brillouin zone in 1D:

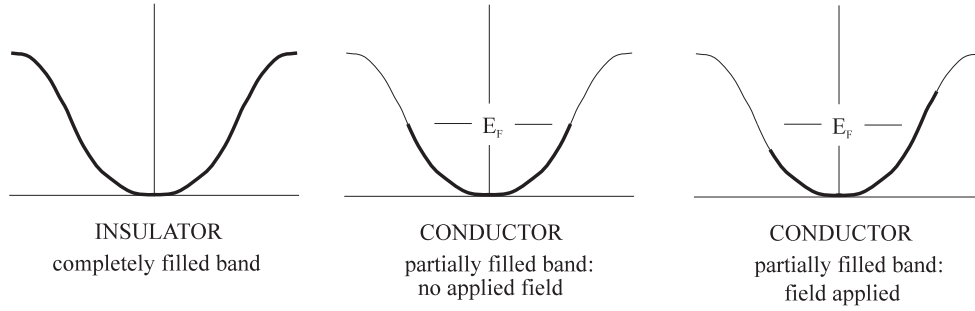

- (a) When there is **no** applied electric field the electrons move equally in all directions and there is no nett transport of charge.
- (b) When an electric field is applied it accelerates some electrons and decelerates others to generate a flow asymmetry. Electrons must vacate some states to occupy other, originally vacant, states.
- (c) If the band is **full** there can be **no** such asymmetry since all states are occupied at all times. Such a system is in the **same** state whether or not an electric field is applied and so there is no nett charge transport: the system is an **insulator**.
- (d) If a band is only partially filled there are vacant states nearby in energy to which an electron can move and the state of the system changes when a field is applied (see figure): the system is a **conductor**.
- (e) In a perfect crystal there is **no** steady state for electrons in a constant applied electric field. They migrate through the Brillouin zone and their velocity oscillates giving an oscillating charge flow. However, this effect can only be seen in very large and perfect crystals at low temperature. In a realizable material lattice vibrations and impurities and imperfections in the crystal cause random jumps in k , and a steady state current arises from detailed balance of accelerating and randomizing forces.

8.3 Semiconductors

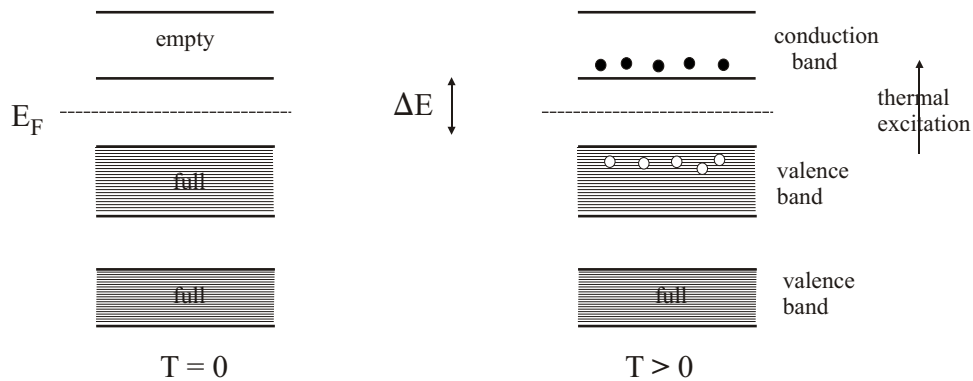

A **semiconductor** is an **insulator** but with a small energy gap between the uppermost filled band and the vacant band above it: $\Delta E \sim 0.6 \text{ eV}$.

- (a) At $T = 0$ all bands are filled and acts as insulator.

- (b) For $T > 0$ significant numbers of electrons are thermally excited into states at **bottom** of conduction band leaving **holes** (i.e. vacant states) at **top** of valence band. The electrons are carriers of **negative** charge. The holes act as carriers of **positive** charge since the dynamics of electrons moving in a nearly full band can be described by the dynamics of the holes; **absence** of a **negative** charge, **negative** mass particle behaves like a **positive** charge, **positive** mass particle: a **hole**. Neither band is completely full and **both** kinds of carrier contribute to conduction.
- (c) The number of carriers is strongly T -dependent and from the Fermi-Dirac distribution behaves exponentially $\sim e^{-\Delta E/k_B T}$. This is why need ΔE small.
- (d) The number of conduction electrons can be increased by **doping** with **donor** impurity atoms which donate electrons to the conduction band by becoming positively ionized. Conversely, the number of conduction holes can be increased by doping with **acceptor** impurities which capture electrons from the valence band leaving holes behind. These semiconductors are known as n -type and p -type, respectively.

8.4 More on Extended Zone Scheme

Most applicable for nearly free model. Consider a $2D$ example with rectangular reciprocal lattice. The 1st and 2nd Brillouin zones are

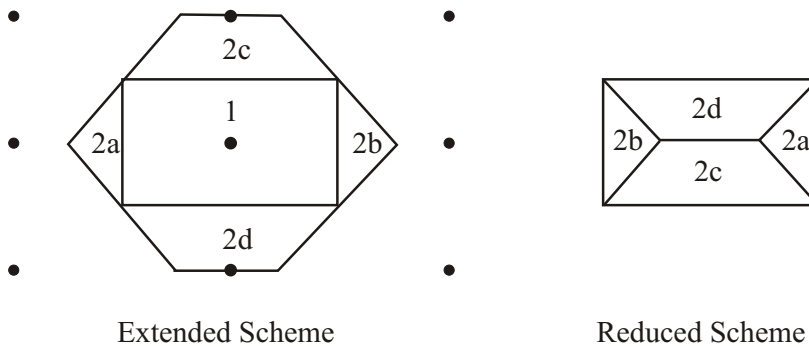

8.4.1 Overlapping Bands

Consider an element with closed shells which should be an insulator. The energy contours for the nearly free model are

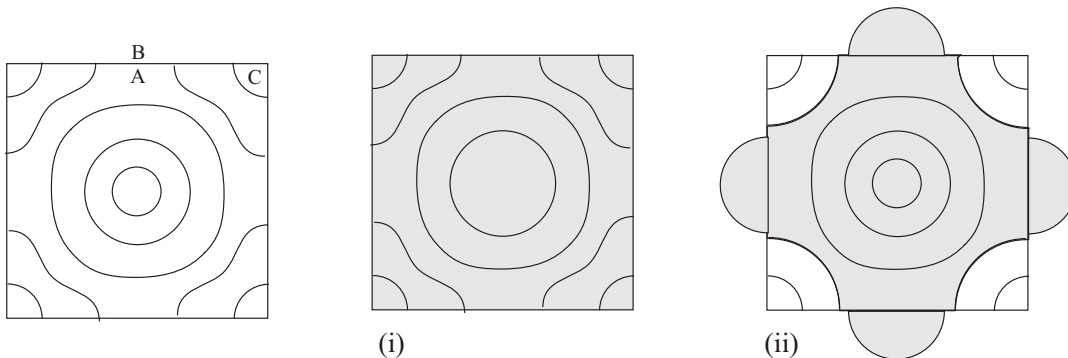

Consider the respective energies of states E_A, E_B, E_C at points A, B, C , where A and C are in the first zone and B in the second zone. In crossing from A to B there is a discontinuity in energy of an amount $\Delta E = E_B - E_A > 0$. There are now two possibilities regarding E_B and E_C :

- (i) $E_B > E_C$. All energies in the first zone are lower than any energy in the second zone and so there are just enough electrons to completely fill all the states in the first zone and the corresponding band is full; all higher ones are empty. The material is indeed an insulator. This is generally true when ΔE is large.
- (ii) $E_B < E_C$. The lowest energy state in the second zone, E_B lies below the top of the highest of the first zone, E_C : the bands overlap. The filling is now different and is shown in the figure above. It is clear that the lower band is not full and there are electrons in the upper band. The material is a conductor albeit probably a poor one. This occurs generally when ΔE is small.

9 Quantum Particle in a Magnetic Field

First review the classical dynamics of a charged particle.

9.1 Classical Hamiltonian

The vacuum Maxwell equations are

$$\begin{aligned}\nabla \cdot \mathbf{E} &= 0, \\ \nabla \cdot \mathbf{B} &= 0, \\ \nabla \wedge \mathbf{E} &= -\dot{\mathbf{B}}, \\ \nabla \wedge \mathbf{B} &= \frac{1}{c^2} \dot{\mathbf{E}}.\end{aligned}\tag{9.1.1}$$

Here “dot” means time derivative. Introduce scalar potential ϕ and vector potential \mathbf{A} so that

$$\begin{aligned}\mathbf{B} &= \nabla \wedge \mathbf{A}, \\ \mathbf{E} &= -\nabla\phi - \dot{\mathbf{A}}.\end{aligned}\tag{9.1.2}$$

The 2nd and 3rd Maxwell equations are automatically satisfied and the 1st and 3rd become wave equations for ϕ and \mathbf{A} . There is a **gauge transformation** which leaves \mathbf{E} and \mathbf{B} unchanged:

$$\mathbf{A} \rightarrow \mathbf{A} + \nabla f, \quad \phi \rightarrow \phi - \dot{f}.\tag{9.1.3}$$

Scalar and vector potentials related by gauge transformations describe the same physics and are equivalent.

The classical Hamiltonian (i.e., the energy function) for a particle of charge $-e$ in the background of these fields is

$$H = \frac{1}{2m}(\mathbf{p} + e\mathbf{A}) \cdot (\mathbf{p} + e\mathbf{A}) - e\phi,\tag{9.1.4}$$

where \mathbf{A} and ϕ are evaluated at the position \mathbf{x} of the particle. Hamilton's equations tell us how to derive the equations of motion:

$$\dot{x}_i = \frac{\partial H}{\partial p_i}, \quad \dot{p}_i = -\frac{\partial H}{\partial x_i}. \quad (9.1.5)$$

Then get

$$\begin{aligned} \dot{x}_i &= \frac{1}{m}(p_i + eA_i), \\ \dot{p}_i &= -\frac{1}{m}(p_j + eA_j)e\partial_i A_j + e\partial_i \phi, \\ \Rightarrow m\ddot{x}_i &= \dot{p}_i + e\dot{A}_i + e\dot{x}_j\partial_j A_i \quad [\text{recall } \mathbf{A} = \mathbf{A}(\mathbf{x}(t))] \\ &= -e\dot{x}_j\partial_i A_j + e\partial_i \phi + e\dot{A}_i + e\dot{x}_j\partial_j A_i \\ &= -e\dot{x}_j(\partial_i A_j - \partial_j A_i) - eE_i \\ \Rightarrow m\ddot{\mathbf{x}} &= -e(\mathbf{E} + \dot{\mathbf{x}} \wedge \mathbf{B}), \quad \text{the Lorentz force law.} \end{aligned} \quad (9.1.6)$$

In a constant uniform magnetic field \mathbf{B} with $\mathbf{E} = 0$ the simple motion is in circular orbits orthogonal to \mathbf{B} with a drift parallel to \mathbf{B} : a helical path. Choosing $\mathbf{B} = B\hat{\mathbf{k}}, B > 0$, we substitute the trial solution

$$\mathbf{x} = (a \cos \omega_B t, a \sin \omega_B t, ct) \quad (9.1.7)$$

into the Lorentz law and find that a and c are arbitrary constants of the motion and

$$\omega_B = \frac{eB}{m}, \quad \text{the cyclotron frequency.} \quad (9.1.8)$$

The orbit is clockwise about the positive $\hat{\mathbf{k}}$ axis.

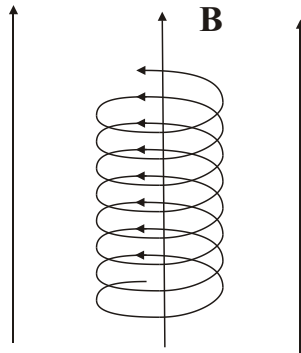

9.2 Quantum Hamiltonian

Replace $\mathbf{p} \rightarrow -i\hbar\nabla$ and then for a spinless particle the Hamiltonian is derived from the classical one above:

$$H_0 = \frac{1}{2m} (-i\hbar\nabla + e\mathbf{A})^2 - e\phi, \quad (9.2.1)$$

and acts on the wavefunction $\Psi(\mathbf{x}, t)$ where \mathbf{A}, ϕ generally depend on \mathbf{x}, t .

For a particle of spin $\frac{1}{2}$ there is a spin operator

$$\mathbf{s} = \frac{1}{2}\hbar\boldsymbol{\sigma}, \quad (9.2.2)$$

where

$$\sigma_1 = \begin{pmatrix} 0 & 1 \\ 1 & 0 \end{pmatrix}, \quad \sigma_2 = \begin{pmatrix} 0 & -i \\ i & 0 \end{pmatrix}, \quad \sigma_3 = \begin{pmatrix} 1 & 0 \\ 0 & 1 \end{pmatrix}, \quad (9.2.3)$$

are the **Pauli matrices**. There is an additional contribution to the Hamiltonian

$$H_s = -\mu\mathbf{B} \cdot \mathbf{s} \equiv -\frac{\mu\hbar}{2}\mathbf{B} \cdot \boldsymbol{\sigma}, \quad (9.2.4)$$

coupling the magnetic moment $\boldsymbol{\mu} = \mu\mathbf{s}$ directly to \mathbf{B} . The full Hamiltonian is then

$$H = H_0\mathbb{I} + H_s, \quad (9.2.5)$$

where \mathbb{I} is the unit 2×2 matrix. The wavefunction now has two components $\Psi = \begin{pmatrix} \psi_1 \\ \psi_2 \end{pmatrix}$. Unless \mathbf{B} points in a uniform direction, this is a genuine matrix Hamiltonian. The Schrödinger equation is

$$i\hbar\frac{\partial}{\partial t}\psi = \frac{1}{2m}(-i\hbar\nabla + e\mathbf{A})^2\psi - e\phi\psi - \mu\mathbf{B} \cdot \mathbf{s}\psi. \quad (9.2.6)$$

Can rewrite as

$$i\hbar\left(\frac{\partial}{\partial t} - \frac{ie}{\hbar}\phi\right)\psi = -\frac{\hbar^2}{2m}\left(\nabla + \frac{ie}{\hbar}\mathbf{A}\right)^2\psi - \mu\mathbf{B} \cdot \mathbf{s}\psi. \quad (9.2.7)$$

Under a gauge transformation \mathbf{A} and ϕ are replaced by

$$\tilde{\mathbf{A}} = \mathbf{A} + \nabla f \quad \text{and} \quad \tilde{\phi} = \phi - \dot{f}. \quad (9.2.8)$$

If we **also** replace ψ by $\tilde{\psi} = e^{-ief/\hbar}\psi$, then $\tilde{\psi}$ obeys the transformed equation:

$$i\hbar\left(\frac{\partial}{\partial t} - \frac{ie}{\hbar}\tilde{\phi}\right)^2\tilde{\psi} = -\frac{\hbar^2}{2m}\left(\nabla + \frac{ie}{\hbar}\tilde{\mathbf{A}}\right)^2\tilde{\psi} - \mu\mathbf{B} \cdot \mathbf{s}\tilde{\psi}. \quad (9.2.9)$$

I.e., the same Schrödinger equation as eqn. (9.2.6) but in terms of the transformed fields; the equation is **gauge covariant**.

- (i) $\tilde{\psi}$ is the gauge transform of ψ .
- (ii) $\nabla + \frac{ie}{\hbar}\mathbf{A}$ and $\frac{\partial}{\partial t} - \frac{ie}{\hbar}\phi$ are called **gauge covariant derivatives**.

These are the only operators that have a physical meaning; $\mathbf{p} = -i\hbar\nabla$ has no simple properties under a gauge transformation and is now only **one part** of the momentum operator which is $-i\hbar(\nabla + \frac{ie}{\hbar}\mathbf{A})$. The meaning is that the total momentum is now stored in the **mechanical** motion of the particle **and** in the electromagnetic field itself; the EM field carries momentum e.g., in a laser beam. A gauge transformation changes the partition between the **mechanical** and **EM field** parts.

From now on just consider time-independent fields \mathbf{B} and $\mathbf{E} \implies \mathbf{A}(\mathbf{x})$ and $\phi(\mathbf{x})$ are independent of time.